

NCP2824EVB/D

NCP2824: Evaluation Board Manual

Prepared by: Dominique ROMEIO

Overview

The NCP2824 is a Filterless Class D amplifier capable of delivering up to 2.4 W to a 4 Ω load with a 5 V supply voltage. With the same battery voltage, it can deliver 1.2 W to an 8 Ω load with less than 1% THD+N. The Non-clipping function adjusts automatically the output voltage in order to control the distortion when an excessive input is applied to the amplifier. This adjustment is done thanks to an Automatic Gain Control circuitry (AGC) built-in the chip. A simple Single wire interface allows to enable/disable the non Clipping function and also to configure the maximum distortion level in the output. A programmable power limit function is also embedded in order to protect speakers from damage caused by an excessive sound level.

..



ON Semiconductor

<http://onsemi.com>

EVALUATION BOARD MANUAL

The intent of the demo boards is to illustrate typical operation of the NCP2824 device for laboratory characterization. The NCP2824EVB schematic is depicted Figure 1

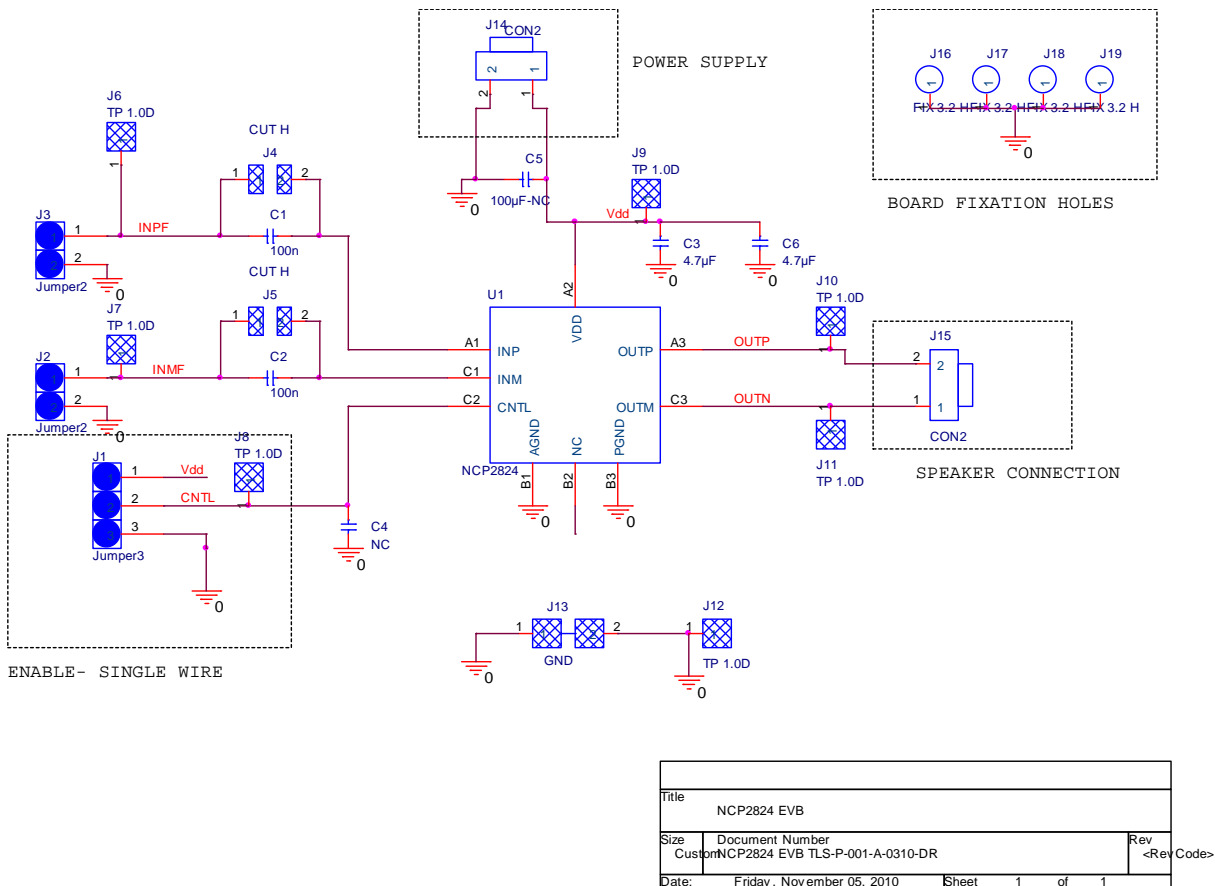

Figure 1. NCP2824EVB Schematic

Title		
NCP2824 EVB		
Size	Document Number	Rev
Custom	NCP2824 EVB TLS-P-001-A-0310-DR	<Rev Code>
Date:	Friday, November 05, 2010	Sheet 1 of 1

NCP2823EVb/D

Operation

The operating power supply of the NCP2824 is from 2.5 to 5.5 V. The absolute maximum input voltage is 7.0 V. A power supply set to 3.6 V and current limit set to at least 1.5 A must be connected to J14 connector to powering the NCP2824EVb/D. Also to compensate for parasitic inductance of wires between the power supply and the evaluation board it is highly recommended to connect a 470 μ F electrolytic capacitor to bypass J14 terminal. Like this the device can be evaluate under powering condition very similar that battery power supplies.

Performances of EVB Solution

To be as close as possible with final handset application, the design of this power conversion solution used small size footprints where possible. Changing components may positively or negatively impact the demo board performance illustrated in Figure 2 to 7 For more information please refer to the NCP2824 datasheet.

Single Wire Interface Operation

The single wire interface allows changing the default configuration of the NCP2824.

After Wake up, the NCP2824 is configured with:

- AGC enable
- Non Clip + Power limit
- Gain=18dB
- THD max=1%

The following table described all the NCP2824 configurations.

Table 1: NCP2824 Configuration

Pulse Counting	Register	Description
01	AGC	AGC disable
02		AGC Enable
03	Reset	Reset configuration
04	Gain Control	Gain=12dB
05		Gain=18dB
06	THD Control	1%
07		2%
08		4%
09		6%
10		8%
11		10%
12		15%
13		20%
14	NC+L	Non Clip + Power limit
15	NC	Non Clip only
16	Power Limit Control	0.45V _{Peak}
17		0.9V _{Peak}
18		1.35V _{Peak}
19		1.8V _{Peak}
20		2.25V _{Peak}
21		2.7V _{Peak}
22		3.15V _{Peak}
23		3.6V _{Peak}

Single Wire commands can easily be emulated using a pulse generator configured in accordance with the Single wire specification, for more information about timings please refers to NCP2824 datasheet.

INPUT POWER

Symbol	Descriptions
J14-1	This is the positive connection for power supply. The leads (positive + ground) to the input supply should be twisted and kept as short as possible.
J14-2	This is the return connection for the power supply (Ground signal)
J13	Ground clip

AUDIO

Symbol	Descriptions
J3	Positive Audio input
J2	Negative Audio input
J15-2	Positive Audio output
J15-1	Negative Audio output

SWITCHES SETUP

Symbol	Switch Descriptions
J1	Enable
J4	Short input capacitor on positive input
J5	Short input capacitor on negative input
J2	Connect the positive audio input to Gnd
J3	Connect the negative audio input to Gnd

NCP2824EVB/D

TEST POINT

Symbol	Switch Descriptions
J12	This test point is directly connected to the GND
J9	This test point is directly connected to the Vdd pin
J6	This test point is connected to the positive audio input
J7	This test point is connected to the negative audio input
J10	This test point is connected to the positive audio output
J11	This test point is connected to the negative audio output

TYPICAL OPERATING CHARACTERISTICS

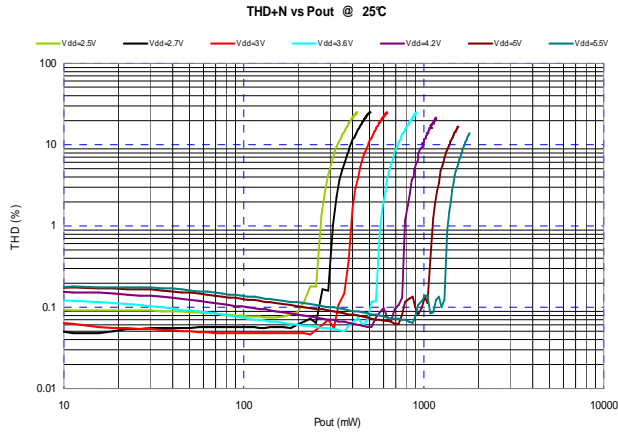

Figure 2. THD vs. P_{OUT}, R_L=8 Ohms, f=1kHz

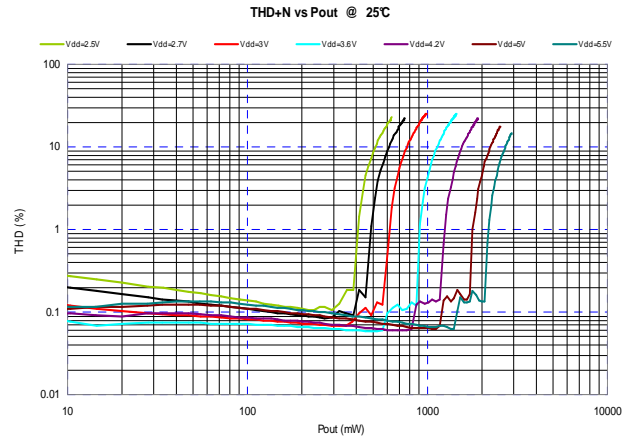

Figure 3. THD vs. P_{OUT}, R_L=4 Ohms, f=1kHz

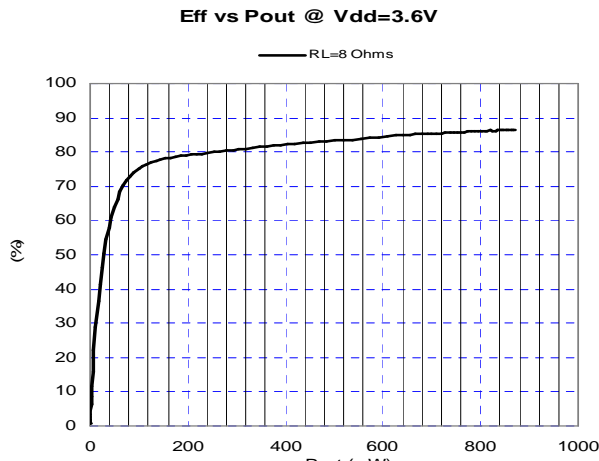

Figure 4. Efficiency vs. P_{OUT}, R_L=8 Ohms, f=1kHz

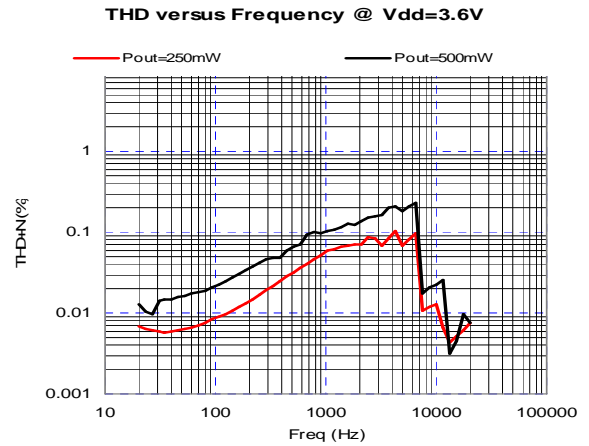

Figure 5. THD vs frequency, R_L=8 Ohms, P_{OUT} =250 mW

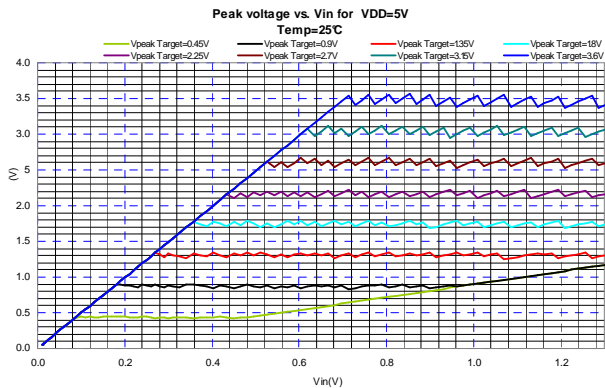

Figure 6. Peak output voltage in Power limit vs input voltage (rms) and Power limit settings, Av=12dB

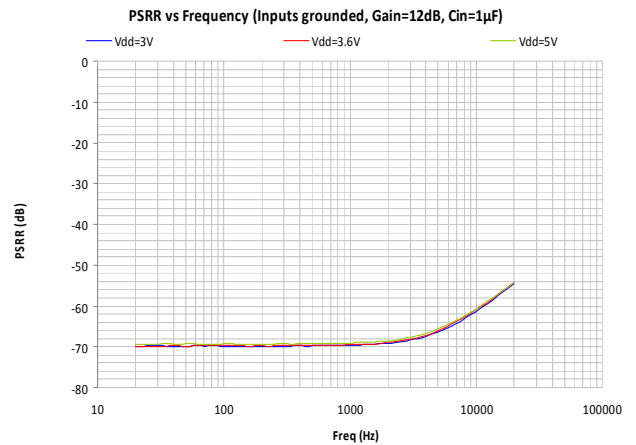

Figure 7. PSRR vs frequency

NCP2824EV/D

PCB Layout

As with all Class D amplifiers, care must be observed to place the components on the PCB and layout the critical nodes. The evaluation board is made of 4 PCB layers where first internal

layer is a GND. Figure 8, Figure 9 and Figure 10 show the layout of the NCP2823EV board. For more specific layout guidelines please refer to the NCP2824 datasheet.

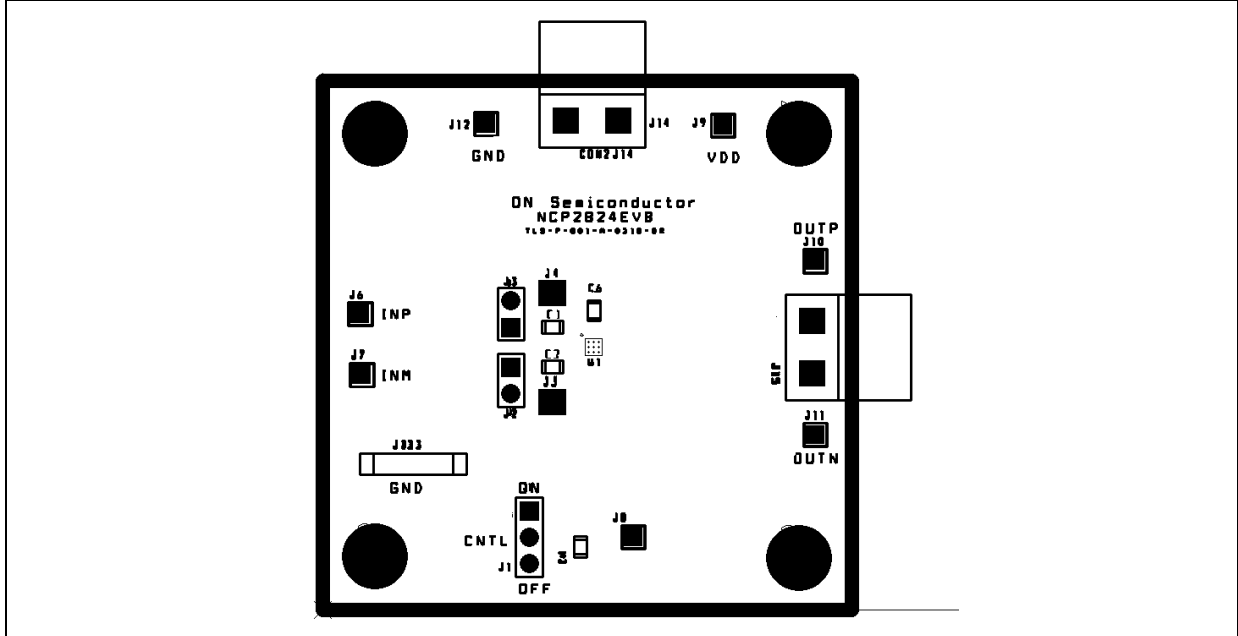

Figure 8: Assembly Layer TOP

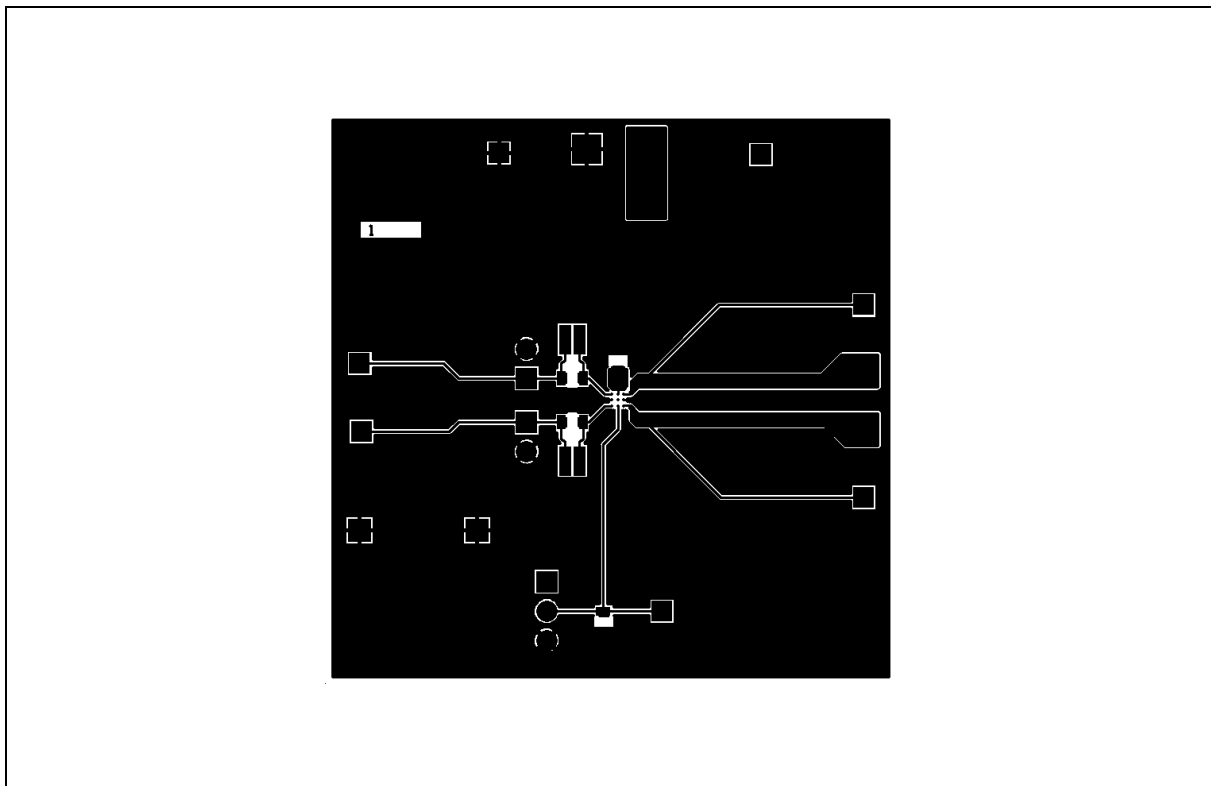

Figure 9: Top Layer Routing

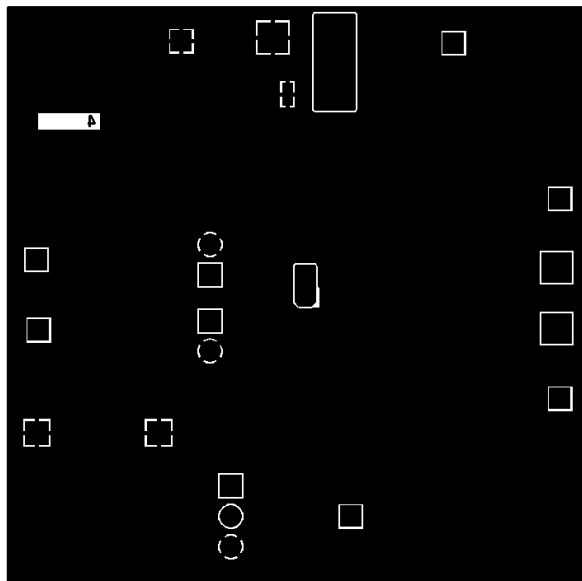

Figure 10: Bottom Layer Routing

NCP2824EVb/D

BILL OF MATERIALS

Qty	Ref Des.	Description	Size	Manufacturer	Part Number
1	U1	NCP2824	CSP-9 1.45x1.4 5 mm	ON Semiconductor	NCP2824
2	C1,C2	Capacitor , Ceramic 100nF	0603	KEMET	C0603C104K5RAC
2	C3,C6	Capacitor, Ceramic 4.7 μ F 6.3 V	0603	KEMET	C0603C475K9PAC
2	J14, J15	Mal. SL5.08/2/90B plus Fem. BLZ 5.08/2		Weidmuller	SL5.08/2/90 + BLZ 5.08/2
3	J1	Header 3 pin, 100 mil spacing	0.100 x 2	Std	Std
2	J2, J3	Header 2 pin, 100 mil spacing	0.100 x 2	Std	Std
1	J6	GND Connection		Std	Std
9	J6,J7,J9 J10,J11, J12,13	Test Point		Std	Std
2	J4, J5	Soldering point must be connected			
1	PCB	PCB 2.0 in x 2.0 in x 1.0 mm, 4 Layers		Any	TLS-P-001-A-0310-DR

.Note: C3 is not mounted