

THIS DRAWING IS UNPUBLISHED. RELEASED FOR PUBLICATION  
 © COPYRIGHT - By - ALL RIGHTS RESERVED.

PROJECT	PRJ-16-000909157
PART NO.	X-2308349-X
DESCRIPTION	CRIMP FLANGES SMALL
CUSTOMER	GENERAL MARKET

REVISIONS				
P	LTR	DESCRIPTION	DATE	APVD
	A2	REVISED PER ECR-16-014891	22FEB2017	KK SE

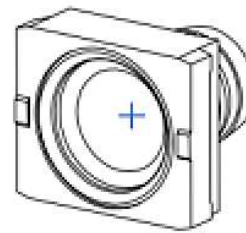
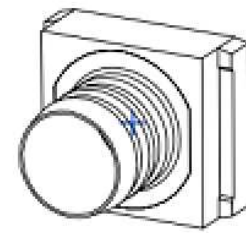
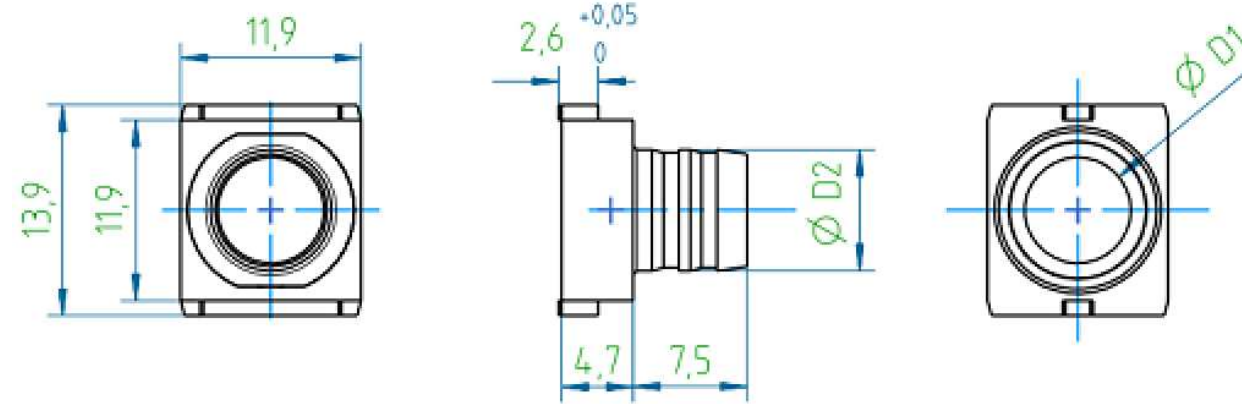

2-2308349-4	CRIMP FLANGE 14 SMALL	3.0	4.0
2-2308349-3	CRIMP FLANGE 13 SMALL	3.5	4.5
2-2308349-2	CRIMP FLANGE 12 SMALL	4.0	5.0
2-2308349-1	CRIMP FLANGE 11 SMALL	4.5	5.5
2-2308349-0	CRIMP FLANGE 10 SMALL	5.0	6.0
1-2308349-9	CRIMP FLANGE 9 SMALL	5.5	6.5
1-2308349-8	CRIMP FLANGE 8 SMALL	5.7	6.7
1-2308349-7	CRIMP FLANGE 7 SMALL	6.0	7.0
1-2308349-6	CRIMP FLANGE 6 SMALL	6.5	7.5
1-2308349-5	CRIMP FLANGE 5 SMALL	7.0	8.0
1-2308349-4	CRIMP FLANGE 4 SMALL	7.6	8.5
1-2308349-3	CRIMP FLANGE 3 SMALL	8.0	9.0
1-2308349-2	CRIMP FLANGE 2 SMALL	8.5	9.5
1-2308349-1	CRIMP FLANGE 1 SMALL	9.0	10.0
PART-NO.	DESCRIPTION	D1	D2

NOTES:

- FINISHING PROCESS: Cu2/Sn4 (FLANGE).
- WEIGHT: 4 g.

THIS DRAWING IS A CONTROLLED DOCUMENT.		DWN KIRAN K 29JUL2016	 TE Connectivity	
DIMENSIONS: mm		CHK GUNASEKHAR G 29JUL2016		
TOLERANCES UNLESS OTHERWISE SPECIFIED: DIN ISO 2768 m.		APVD GUNASEKHAR G 29JUL2016	NAME CRIMP FLANGES SMALL	
0 PLC ± - 1 PLC ± - 2 PLC ± - 3 PLC ± - 4 PLC ± - ANGLES ± -		PRODUCT SPEC -	RESTRICTED TO -	
MATERIAL -		FINISH -	APPLICATION SPEC -	WEIGHT
		SIZE A3		CAGE CODE 00779
		DRAWING NO C-2308349		SCALE NTS
		CUSTOMER DRAWING		SHEET 1 OF 2
				REV A2

THIS DRAWING IS UNPUBLISHED. RELEASED FOR PUBLICATION  
 © COPYRIGHT - By - ALL RIGHTS RESERVED.

REVISIONS					
P	LTR	DESCRIPTION	DATE	DWN	APVD
-	-	SEE SHEET 1	-	-	-

CRIMP BARREL, CRIMP INSERT AND CRIMP TOOL SELECTION PROCEDURE

SELECTION CHART AND CRIMP TOOLS

Step	Description	Example
1.	Measure the outside cable diameter (3 times on different places at different angles)	OD = 6.5mm
2.	Strip the cable and remove the cable braiding	
3.	Measure the diameter of the inner cable bundle including the foil	ID = 4.4mm
4.	Select the crimp flange with a hole diameter next up to the cable bundle diameter	PN 2-2308349-1, ID=4.5mm, OD=5.5mm
5.	Calculate the recommended barrel inner diameter with the following formula: <i>Recommended Inner crimp barrel diameter = OD of crimp flange + 2x(thickness of the cable jacket) + 0.2mm</i>	Thickness cable jacket = (6.5-4.4)/2=1.05mm Barrel ID= 5.5mm + 2x1.05 + 0.2mm = 7.8mm
6.	Select the crimp barrel with the next size up	PN 1-2308350-7, ID=8.0mm, OD= 9.0mm
7.	Order the correct crimp tool + crimp insert using the crimp barrel selection matrix	PN 1-2823557-1 & 1-2823558-3

Picture	PN Crimp Barrel	Inner diameter	Outer diameter	PN Recommended crimp insert
	1-2308350-1	5.0	6.0	1-2823558-8
	1-2308350-2	5.5	6.5	1-2823558-9
	1-2308350-3	6.0	7.0	2-2823558-0
	1-2308350-4	6.5	7.5	2-2823558-1
	1-2308350-5	7.0	8.0	1-2823558-1
	1-2308350-6	7.5	8.5	1-2823558-2
	1-2308350-7	8.0	9.0	1-2823558-3
	1-2308350-8	8.5	9.5	1-2823558-4
	1-2308350-9	9.0	10.0	1-2823558-5
	2-2308350-0	9.5	10.5	1-2823558-6
	2-2308350-1	10.0	11.0	1-2823558-7
	2-2308350-2	10.5	11.5	2-2823558-9
	2-2308350-3	11.0	12.0	3-2823558-0
	2-2308350-4	11.5	12.5	3-2823558-1
	2-2308350-5	11.7	13.0	3-2823558-2
	2-2308350-6	12.0	13.0	3-2823558-3
	2-2308350-7	12.5	13.5	3-2823558-4
2-2308350-8	13.0	14.0	3-2823558-5	
2-2308350-9	13.7	15.0	3-2823558-6	
3-2308350-0	14.0	15.0	3-2823558-7	
3-2308350-1	14.5	15.5	3-2823558-8	
3-2308350-2	16.0	17.0	3-2823558-9	



1-2823559-1 stripping tool



1-2314418-1 Crimp flange insertion tool

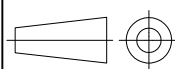

Crimp tool 1-2823557-1  
Crimp insert X-2823558-X

THIS DRAWING IS A CONTROLLED DOCUMENT.		DWN KIRAN K 29JUL2016	 TE Connectivity		
DIMENSIONS: mm		CHK GUNASEKHAR G 29JUL2016			
		APVD GUNASEKHAR G 29JUL2016	NAME CRIMP FLANGES SMALL		
TOLERANCES UNLESS OTHERWISE SPECIFIED:		PRODUCT SPEC	SIZE		
0 PLC ± -		APPLICATION SPEC	CAGE CODE		
1 PLC ± -		WEIGHT	DRAWING NO		
2 PLC ± -		CUSTOMER DRAWING	RESTRICTED TO		
3 PLC ± -			SCALE		
4 PLC ± -			SHEET		
ANGLES ± -			REV		
MATERIAL			2 of 2		
FINISH			A2		