

## PTC Thermistors For Overload And Overcurrent Protection



### FEATURES

- Different voltages to be chosen in function of the application
- Available in three mechanical versions:
  - 2322 66. 4.... naked discs
  - 2322 66. 5.... leaded and coated
  - 2322 66. 6.... taped, on reel (to diameter 12.5 mm)
- Wide range of trip and non-trip currents: from 17 mA up to 4.5 A for the trip current
- Wide range of resistance: from 0.3  $\Omega$  up to 3 k $\Omega$
- Small ratio between trip and non-trip currents ( $I_t/I_{nt} = 1.5$  at 25  $^{\circ}\text{C}$ )
- High maximum inrush current
- Excellent long term behaviour, also in humidity
- Leaded parts withstand mechanical stresses and vibration
- UL approved PTCs are guaranteed to withstand severe test programmes including:
  - long-life cycle tests (over 5000 trip cycles)
  - long-life storage tests (3000 hours at 250  $^{\circ}\text{C}$ )
  - electrical cycle tests at low ambient temperatures ( $-40^{\circ}\text{C}$  or  $0^{\circ}\text{C}$ )
  - damp-heat and water immersion tests
  - overvoltage tests at up to 200% of rated voltage.
- UL file E148885 according to XGPU2 standard UL1434.

QUICK REFERENCE DATA		
PARAMETER	VALUE	UNIT
Switch temperature; note 1	140	$^{\circ}\text{C}$
Maximum voltage; note 2:		
2322 66. 5...4	20	V (DC)
2322 66. 4/5/6...1	30 to 60	V (DC)
2322 66. 4/5/6...2	145	V (RMS)
2322 66. 4/5/6...3	265	V (RMS)
Temperature range:		
2322 66. 4/5/6...1	$-40$ to $+85$	$^{\circ}\text{C}$
2322 66. 4/5/6...2	0 to 70	$^{\circ}\text{C}$
2322 66. 4/5/6...3	0 to 70	$^{\circ}\text{C}$
Climatic category:		
66. 4/5/6...1	40/125/56	
66. 4/5/6...2/3	25/125/56	

### Notes

1. 2322 660 5 ...4 types, have a 155 $^{\circ}\text{C}$  switch temperature.
2. 2322 660 4/5/6 ...3 types, have a 120  $^{\circ}\text{C}$  switch temperature.
3. Rated voltages are respectively:
  - 24 to 48 V (AC or DC)
  - 120 V (AC or DC)
  - 230 V (AC or DC).

### APPLICATIONS

- Telecommunications
- Automotive systems
- Industrial electronics
- Consumer electronics
- Electronic data processing

### DESCRIPTION

These directly heated thermistors have a positive temperature coefficient and are primarily intended for overload protection. They consist of a naked disc or with two tinned brass or copper clad steel leads and coated.

### PACKAGING

All tape and reel specifications are in accordance with "IEC 60286-3".

**VERY LOW VOLTAGE TYPES 20 V**

<b>ELECTRICAL DATA AND ORDERING INFORMATION</b> for 2322 66. 5...4; max. voltage = 20 V (ac or dc) <sup>(1)</sup>							
$I_{nt}$ MAX. at 25 °C (mA)	$I_t$ MIN. at 25 °C (mA)	$R_{25}$ $\pm 20\%$ ( $\Omega$ )	$I^{(4)}$ MAX. at 25 °C (mA)	$I_{res}$ MAX. at $V_{max}$ and 25 °C (mA)	DISSIP. FACTOR (mW/K)	TYPICAL $\varnothing D$ (mm)	CATALOG NUMBERS
350	525	4.10	3.5	80	7.0	5	2322 660 53514
470	705	2.30	4.7	100	7.0	5	2322 660 54714
610	915	1.55	6.7	120	8.0	7	2322 661 56114
700	1050	1.20	7.7	125	8.0	7	2322 661 57014
900	1350	0.80	10	150	8.8	8.5	2322 661 59014
1200	1800	0.50	13	200	10.0	10.5	2322 662 51224
1600	2400	0.33	17	260	11.6	12.5	2322 662 51624
2200	3300	0.22	24	320	15.0	16.5	2322 663 52224
3000	4500	0.15	33	400	19.0	20.5	2322 664 53024

**LOW VOLTAGE TYPES 30 - 60 V**

<b>ELECTRICAL DATA AND ORDERING INFORMATION</b> for 2322 66. 4/5/6...1; max. voltage = 30 to 60 V (ac or dc) <sup>(1)</sup>									
$I_{nt}^{(2)}$ MAX. at 25 °C (mA)	$I_t^{(2)}$ MIN. at 25 °C (mA)	$R_{25}$ $\pm 20\%$ ( $\Omega$ )	$V$ MAX. (V)	$I^{(4)}$ MAX. at 25 °C (mA)	$I_{res}$ MAX. at $V_{max}$ and 25 °C (mA)	DISSIP. FACTOR (mW/K)	TYPICAL $\varnothing D$ (mm)	CATALOG NUMBERS <sup>(3)</sup>	
								BULK	TAPE ON REEL
94	145	50	60	800	22	6.9	4.5	2322 660 59491	2322 660 69491
130	195	25	60	1200	25	6.9	4.5	2322 660 51311	2322 660 61311
180	270	13	30	1700	45	6.9	4.5	2322 660 51811	2322 660 61811
270	405	6	30	2500	60	6.9	4.5	2322 660 52711	2322 660 62711
320	480	5	30	3500	62	7.8	6.5	2322 661 53211	2322 661 63211
410	615	3	30	4500	65	7.8	6.5	2322 661 54111	2322 661 64111
470	705	2.5	30	5000	70	8.8	8.0	2322 661 54711	2322 661 64711
540	810	1.9	30	6000	75	8.8	8.0	2322 661 55411	2322 661 65411
610	915	1.7	30	7000	80	9.9	10	2322 662 56111	2322 662 66111
700	1050	1.3	30	8000	90	9.9	10	2322 662 57011	2322 662 67011
830	1245	1.1	30	10000	100	11.5	12	2322 662 58311	2322 662 68311
920	1380	0.9	30	11000	105	11.5	12	2322 662 59211	2322 662 69211
1 170	1755	0.7	30	13500	140	14.5	16	2322 663 51121	-
1390	2085	0.5	30	16000	170	14.5	16	2322 663 51321	-
1770	2655	0.4	30	20000	200	18.7	20	2322 664 51721	-
2050	3075	0.3	30	23000	220	18.7	20	2322 664 52021	-

**Notes**

1. The thermistors are clamped at the seating plane.
2. For leadless types the values given for  $I_{nt}$  and  $I_t$  are only valid for thermistors mounted in accordance with "IEC 60738". Thermistor dissipation depends on mounting and can slightly affect the typical values.
3. For leadless types replace the 8<sup>th</sup> digit in the catalog numbers by 4.
4.  $I_{max}$  is the maximum overload current that may flow through the PTC when it passes from the low ohmic to the high ohmic state.



**MAINS VOLTAGE TYPES 145 V**

<b>ELECTRICAL DATA AND ORDERING INFORMATION</b> for 2322 66. 4/5/6...2; max. voltage = 145 V (ac or dc) <sup>(1)</sup>								
I <sub>nt</sub> (2) MAX. at 25 °C (mA)	I <sub>t</sub> (2) MIN. at 25 °C (mA)	R <sub>25</sub> ±20% (Ω)	I(4) MAX. at 25 °C (mA)	I <sub>res</sub> MAX. at V <sub>max</sub> and 25 °C (mA)	DISSIP. FACTOR (mW/K)	TYPICAL ØD (mm)	CATALOG NUMBERS <sup>(3)</sup>	
							BULK	TAPE ON REEL
47	70	240	200	9	7.3	4.5	2322 660 54792	2322 660 64792
65	100	115	300	11	7.3	4.5	2322 660 56592	2322 660 66592
93	140	55	450	13	7.3	4.5	2322 660 59392	2322 660 69392
110	165	40	500	13	7.3	4.5	2322 660 51112	2322 660 61112
130	195	28	600	13	7.3	4.5	2322 660 51312	2322 660 61312
170	255	19	1000	15	8.3	6.5	2322 661 51712	2322 661 61712
210	315	12	1400	15	8.3	6.5	2322 661 52112	2322 661 62112
250	375	9.4	2000	16.5	9	8.0	2322 661 52512	2322 661 62512
270	405	8	2200	16.5	9	8.0	2322 661 52712	2322 661 62712
320	480	6.7	3000	19	10.5	10	2322 662 53212	2322 662 63212
360	540	5.3	3500	19	10.5	10	2322 662 53612	2322 662 63612
410	615	4.6	4500	22.5	11.7	12	2322 662 54112	2322 662 64112
450	675	3.8	5000	22.5	11.7	12	2322 662 54512	2322 662 64512
600	900	2.9	7200	28.5	15.5	16	2322 663 56012	-
710	1065	2.1	8500	28.5	15.5	16	2322 663 57112	-
880	1320	1.7	11000	37.5	19.8	20	2322 664 58812	-
1000	1500	1.3	13000	37.5	19.8	20	2322 664 51022	-

**MAINS VOLTAGE TYPES 265 V**

<b>ELECTRICAL DATA AND ORDERING INFORMATION</b> for 2322 66. 4/5/6...3; max. voltage = 265 V (ac or dc) <sup>(1)</sup>								
I <sub>nt</sub> (2) MAX. at 25 °C (mA)	I <sub>t</sub> (2) MIN. at 25 °C (mA)	R <sub>25</sub> ±25% (Ω)	I(4) MAX. at 25 °C (mA)	I <sub>res</sub> MAX. at V <sub>max</sub> and 25 °C (mA)	DISSIP. FACTOR (mW/K)	TYPICAL ØD (mm)	CATALOG NUMBERS <sup>(3)</sup>	
							BULK	TAPE ON REEL
11	17	3000	80	6.5	7.3	4.5	2322 660 51193	2322 660 61193
15	23	1900	110	6.5	7.3	4.5	2322 660 51593	2322 660 61593
19	29	1200	140	6.5	7.3	4.5	2322 660 51993	2322 660 61993
28	42	500	200	6.8	7.3	4.5	2322 660 52893	2322 660 62893
39	59	260	300	6.8	7.3	4.5	2322 660 53993	2322 660 63993
63	95	120	450	7	7.3	4.5	2322 660 56393	2322 660 66393
76	115	85	550	7	7.3	4.5	2322 660 57693	2322 660 67693
95	143	56	600	7	7.3	4.5	2322 660 59593	2322 660 69593
110	165	48	650	7.5	8.3	6.5	2322 661 51113	2322 661 61113
140	210	29	800	8	8.3	6.5	2322 661 51413	2322 661 61413
170	255	22	900	9	9	8.0	2322 661 51713	2322 661 61713
190	285	18	1000	9.5	9	8.0	2322 661 51913	2322 661 61913
210	315	17	1300	10	10.5	10	2322 662 52113	2322 662 62113
250	375	12	1500	11	10.5	10	2322 662 52513	2322 662 62513
280	420	11	1800	12	11.7	12	2322 662 52813	2322 662 62813
320	480	8.4	2200	13	11.7	12	2322 662 53213	2322 662 63213
400	600	6.6	3000	15	15.5	16	2322 663 54013	-
490	735	4.4	3500	16	15.5	16	2322 663 54913	-
590	855	4	4500	19.5	19.8	20	2322 664 55913	-
700	1050	2.8	5500	21	19.8	20	2322 664 57013	-
800	1200	2.1	5500	22.5	19.8	20	2322 664 58013(5)	-

**Notes**

1. The thermistors are clamped at the seating plane.
2. For leadless types the values given for I<sub>nt</sub> and I<sub>t</sub> are only valid for thermistors mounted in accordance with "IEC 60738". Thermistor dissipation depends on mounting and can slightly affect the typical values.
3. For leadless types replace the 8<sup>th</sup> digit in the catalog numbers by 4.
4. I<sub>max</sub> is the maximum overload current that may flow through the PTC when it passes from the low ohmic to the high ohmic state.
5. Not UL approved.

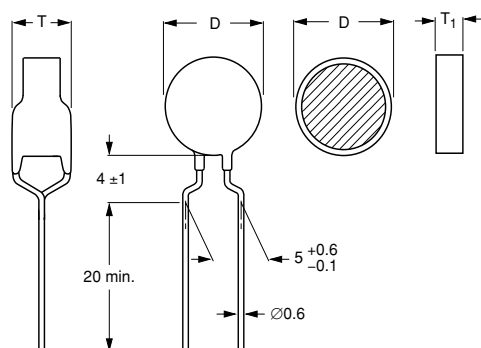
**DIMENSIONS** in millimeters

Component outline for 2322 66. 4/5...1/2/3.

**THICKNESS DIMENSIONS AND CATALOG NUMBERS**

T <sub>1</sub> MAX.	T MAX.	CATALOG NUMBERS 2322 ... .....
N.A.	3.0	66. 5...4
1.7	4.0	66. 4/5...1
2.8	5.0	66. 4/5...2
3.2	5.5	66. 4/5...3

**DEVICE AND TAPE DIMENSIONS, PACKAGING AND CATALOG NUMBERS** in millimeters

D MAX.	H <sub>1</sub> MAX.	H <sub>3</sub> MAX.	PACKAGING AND CATALOG NUMBERS 2322 ... .....		
			NAKED	LEADED BULK	LEADED TAPED
5	26	9.5	660 49491; 660 41311; 660 41811; 660 42711; 660 44792; 660 46592; 660 49392; 660 41112; 660 41312; 660 41193; 660 41593; 660 41993; 660 42893; 660 43993; 660 46393; 660 47693; 660 49593	660 59491; 660 51311; 660 51811; 660 52711; 660 54792; 660 56592; 660 59392; 660 51112; 660 51312; 660 51193; 660 51593; 660 51993; 660 52893; 660 53993; 660 56393; 660 57693; 660 53514; 660 54714; 660 59593	660 69491; 660 61311; 660 61811; 660 62711; 660 64792; 660 66592; 660 69392; 660 61112; 660 61312; 660 61193; 660 61593; 660 61993; 660 62893; 660 63993; 660 66393; 660 67693; 660 69593
7	28	11.5	661 43211; 661 44111; 661 41712; 661 42112; 661 41113; 661 41413	661 53211; 661 54111; 661 51712; 661 52112; 661 51113; 661 51413; 661 56114; 661 57014	661 63211; 661 64111; 661 61712; 661 62112; 661 61113; 661 61413
8.5	29.5	13.0	661 44711; 661 45411; 661 42512; 661 42712; 661 41713; 661 41913	661 54711; 661 55411; 661 52512; 661 52712; 661 51713; 661 51913; 661 59014	661 64711; 661 65411; 661 62512; 661 62712; 661 61713; 661 61913
10.5	31.5	15.0	662 46111; 662 47011; 662 43212; 662 43612; 662 42113; 662 42513	662 56111; 662 57011; 662 53212; 662 53612; 662 52113; 662 52513; 662 51224	662 66111; 662 67011; 662 63212; 662 63612; 662 62113; 662 62513
12.5	32.5	17.0	662 48311; 662 49211; 662 44112; 662 44512; 662 42813; 662 43213	662 58311; 662 59211; 662 54112; 662 54512; 662 52813; 662 53213; 662 51624	662 68311; 662 69211; 662 64112; 662 64512; 662 62813; 662 63213
16.5	-	-	663 41121; 663 41321; 663 46012; 663 47112; 663 44013; 663 44913	663 51121; 663 51321; 663 56012; 663 57112; 663 54013; 663 54913; 663 52224	-
20.5	-	-	664 41721; 664 42021; 664 48812; 664 41022; 664 45913; 664 47013	664 51721; 664 52021; 664 58812; 664 51022; 664 55913; 664 57013; 664 53024	-



**I<sub>MAX</sub> AS A FUNCTION OF VOLTAGE.**

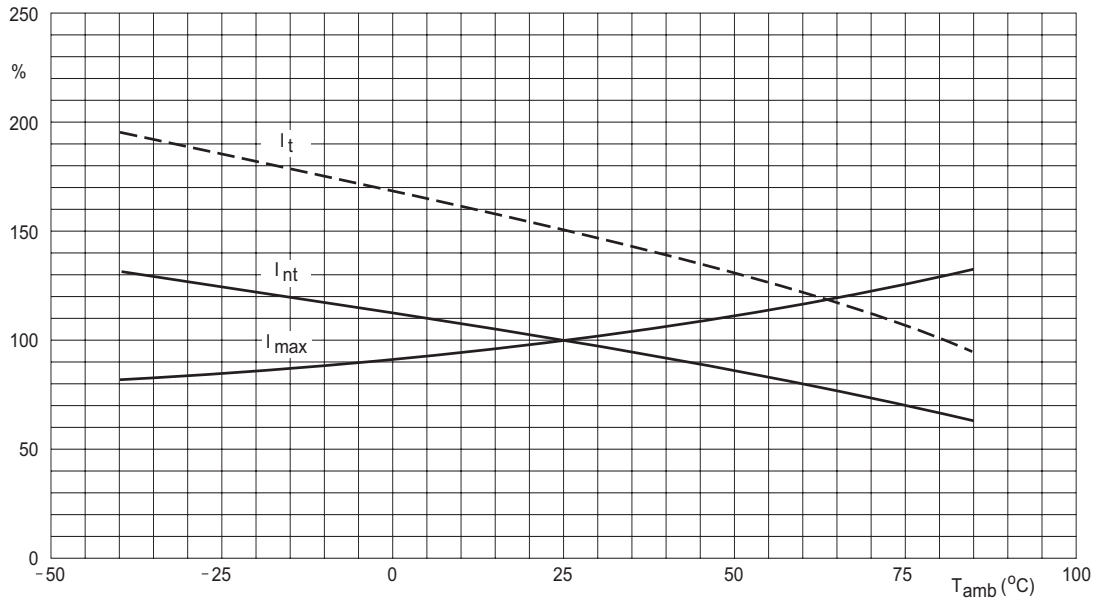

**CURRENT DEVIATION AS A FUNCTION OF THE AMBIENT TEMPERATURE.**

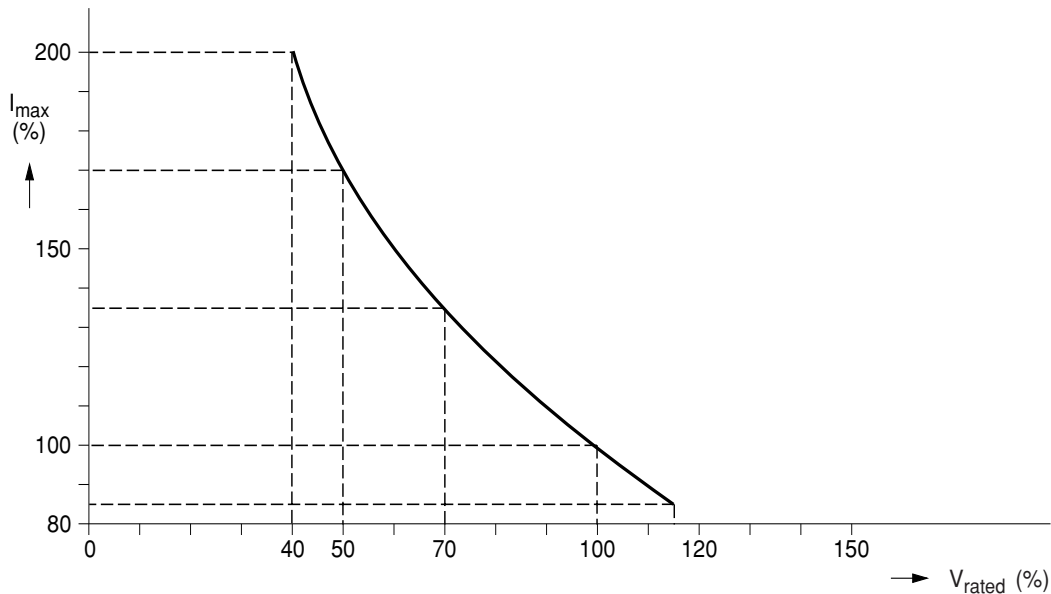

$I_{max}$  as stated in the Electrical data and ordering information tables, is the maximum overload current that may flow through the PTC when passing from the low ohmic to high ohmic state at rated voltage.

When other voltages are present after tripping, the  $I_{max}$  value can be derived from the above  $I_{max}$  as a function of voltage graph. Voltages below  $V_{rated}$  will allow higher overload currents to pass the ptc.

**Example**

What maximum overload current is allowed for a thermistor type 2322 662 52513 at 0 °C and a maximum voltage after tripping of 180  $V_{RMS}$ :

$I_{max}$  at 230 V and 25 °C = 1.5  $A_{RMS}$ : see electrical data and ordering information for 2322 66. 4/5/6...3; max. voltage = 265 V (ac or dc) table.

$I_{max}$  at 180 V and 25 °C = 1.85  $A_{RMS}$  (180  $V_{RMS}$  = 78% of 230  $V_{RMS}$  gives 123% of  $I_{max}$ ).

At 0 °C this gives 1.68  $A_{RMS}$  maximum overload current. See Current deviation as a function of the ambient temperature drawing.



**TYPICAL TRIP-TIME AS A FUNCTION OF TRIP CURRENT RATIO** for 30 to 60 volt types.

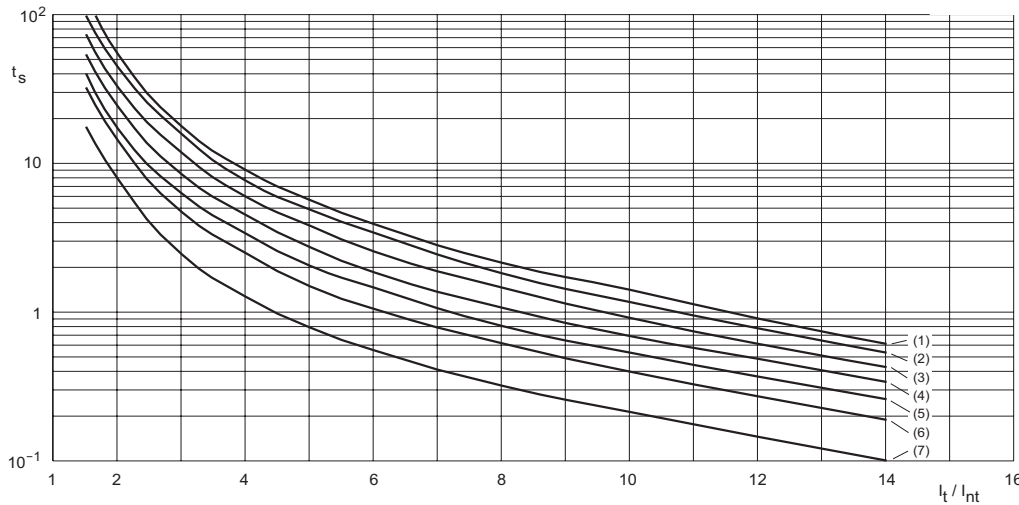

Curve 1: typical  $\varnothing D = 20$  mm.  
 Curve 2: typical  $\varnothing D = 16$  mm.  
 Curve 3: typical  $\varnothing D = 12.0$  mm.  
 Curve 4: typical  $\varnothing D = 10.0$  mm.  
 Curve 5: typical  $\varnothing D = 8.0$  mm.  
 Curve 6: typical  $\varnothing D = 6.5$  mm.  
 Curve 7: typical  $\varnothing D = 4.5$  mm.  
 Measured in accordance with "IEC 60738".  
 For an example, see "Trip-time or switching time ( $t_s$ )".

**TYPICAL TRIP-TIME AS A FUNCTION OF TRIP CURRENT RATIO** for 145 and 265 volt types.

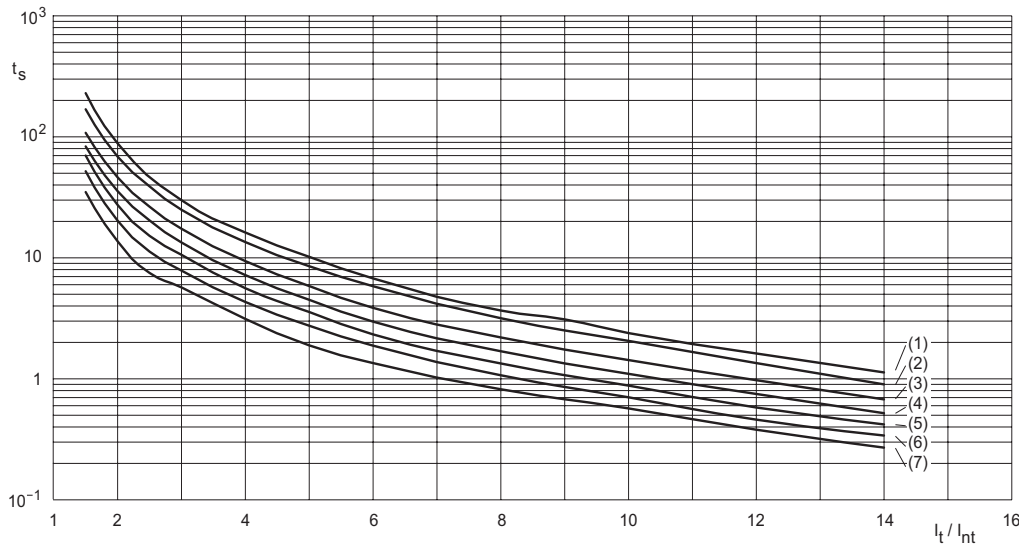

Curve 1: typical  $\varnothing D = 20.0$  mm.  
 Curve 2: typical  $\varnothing D = 16.0$  mm.  
 Curve 3: typical  $\varnothing D = 12.0$  mm.  
 Curve 4: typical  $\varnothing D = 10.0$  mm.  
 Curve 5: typical  $\varnothing D = 8.0$  mm.  
 Curve 6: typical  $\varnothing D = 6.5$  mm.  
 Curve 7: typical  $\varnothing D = 4.5$  mm.  
 Measured in accordance with "IEC 60738".  
 For an example, see "Trip-time or switching time ( $t_s$ )".

**Trip-time or switching time ( $t_s$ )**

To check the trip-time for a specific PTC, refer to the Electrical Data and Ordering Information tables for the value  $I_{nt}$ . Divide the overload or trip current by this  $I_{nt}$  and you realize the factor  $I_t/I_{nt}$ . This rule is valid for any ambient temperature between 0 and 70 °C. Adapt the correct non-trip current with the appropriate curve in the Current Deviation as a Function of the Ambient Temperature graph. The relationship between the  $I_t/I_{nt}$  factor and the switching time is a function of the PTC diameter; see the above graphs.

**Example**

What will be the trip-time at  $I_{ol} = 3$  A and  $T_{amb} = 0$  °C of a thermistor type 2322 661 54711; 2.5  $\Omega$ ;  $\varnothing D = 8.0$  mm:

$I_{nt}$  from Table 1: 470 mA at 25 °C

$I_{nt}$ :  $470 \times 1.12 = 526$  mA (0 °C).

Overload current = 3 A; factor  $I_t/I_{nt}$ :  $\sqrt[3]{0.526} = 5.70$ . In the typical trip-time as a function of trip current ratio for 30 to 60 volt types graph, at the 8.0 mm line and  $I_t/I_{nt} = 5.70$ , the typical trip-time is 1.7 s.



**TYPICAL R/T CHARACTERISTICS**  
**TYPICAL RESISTANCE/TEMPERATURE**  
**CHARACTERISTIC** for 2322 660 53514.

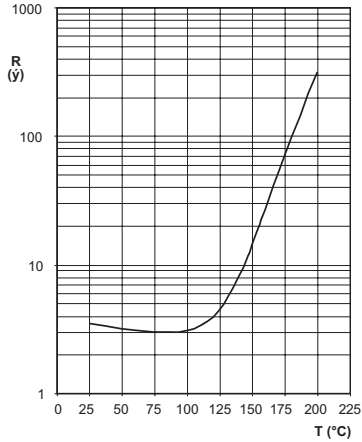

**TYPICAL RESISTANCE/TEMPERATURE**  
**CHARACTERISTIC** for 2322 660 54714.

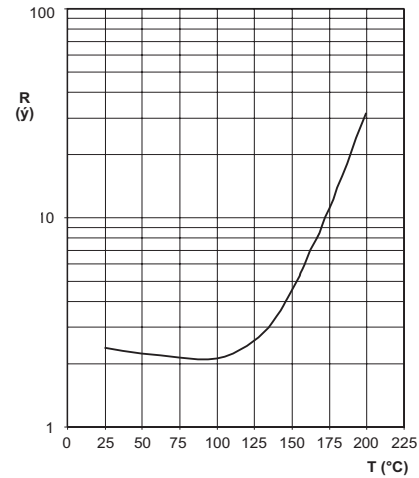

**TYPICAL RESISTANCE/TEMPERATURE**  
**CHARACTERISTIC** for 2322 660 54714.

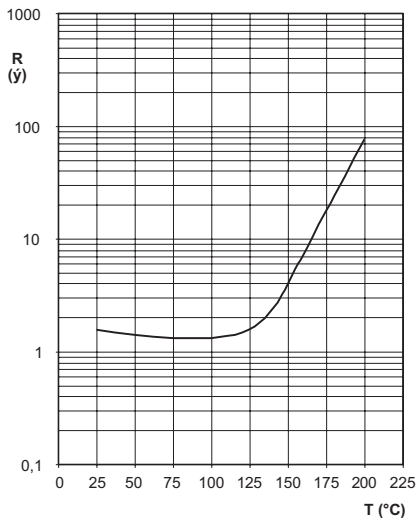

**TYPICAL RESISTANCE/TEMPERATURE**  
**CHARACTERISTIC** for 2322 661 57014.

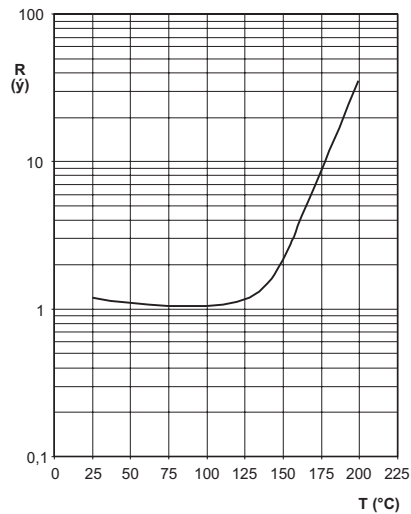

**TYPICAL RESISTANCE/TEMPERATURE**  
**CHARACTERISTIC** for 2322 661 59014.

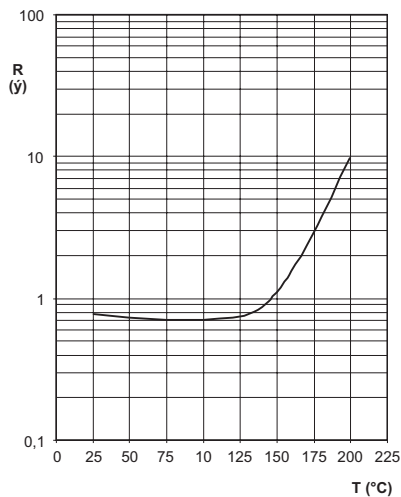

**TYPICAL RESISTANCE/TEMPERATURE**  
**CHARACTERISTIC** for 2322 662 51224.

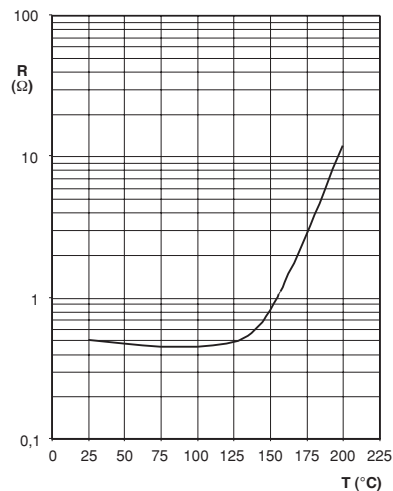



**TYPICAL RESISTANCE/TEMPERATURE CHARACTERISTIC** for 2322 662 51624.

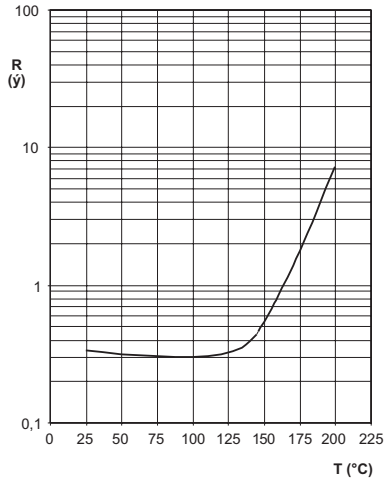

**TYPICAL RESISTANCE/TEMPERATURE CHARACTERISTIC** for 2322 663 52224.

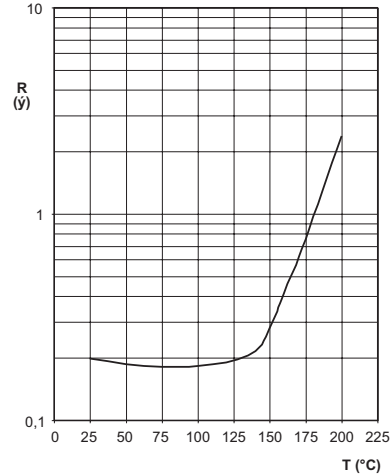

**TYPICAL RESISTANCE/TEMPERATURE CHARACTERISTIC** for 2322 660 59491/51311.

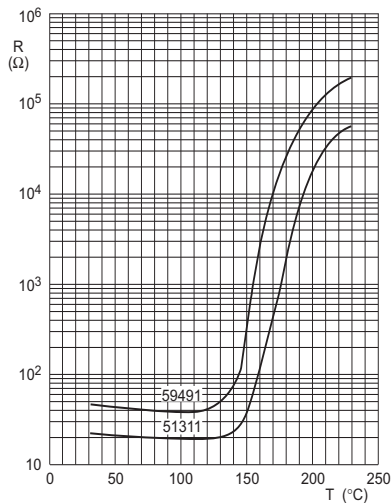

**TYPICAL RESISTANCE/TEMPERATURE CHARACTERISTIC** for 2322 660 51811/52711 and 661 53211.

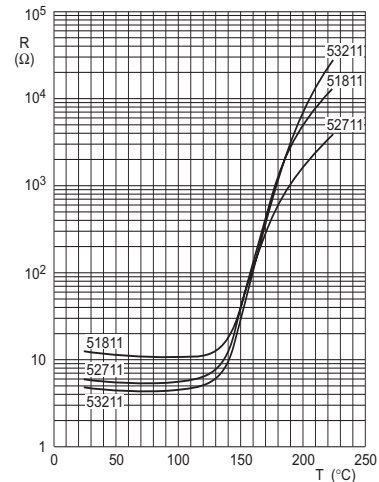

**TYPICAL RESISTANCE/TEMPERATURE CHARACTERISTIC** for 2322 662 56111/57011/58311.

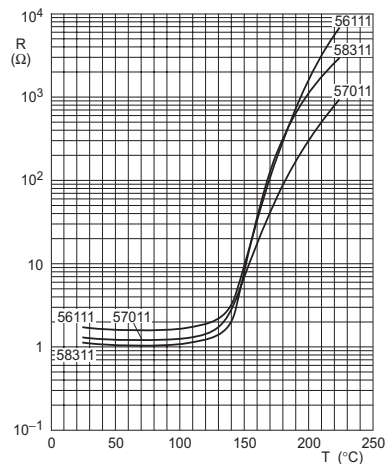

**TYPICAL RESISTANCE/TEMPERATURE CHARACTERISTIC** for 2322 662 59211 and 663 51121/51321.

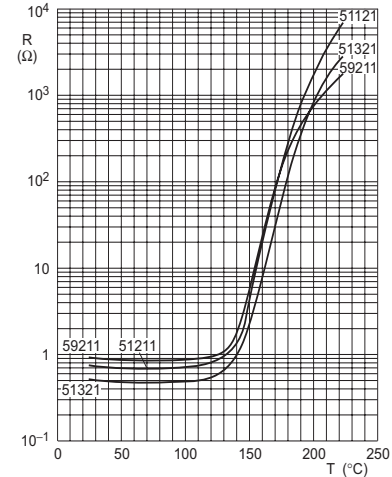





**TYPICAL RESISTANCE/TEMPERATURE  
CHARACTERISTIC** for  
2322 661 54111/54711/55411.

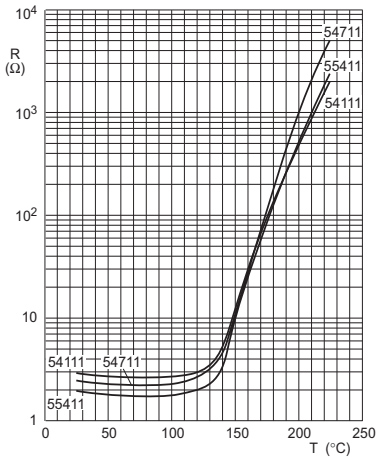

**TYPICAL RESISTANCE/TEMPERATURE  
CHARACTERISTIC** for 2322 664 51721/52021.

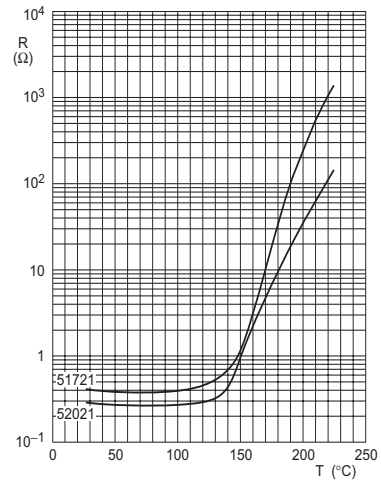

**TYPICAL RESISTANCE/TEMPERATURE  
CHARACTERISTIC** for 2322 660 54792/56592/59392.

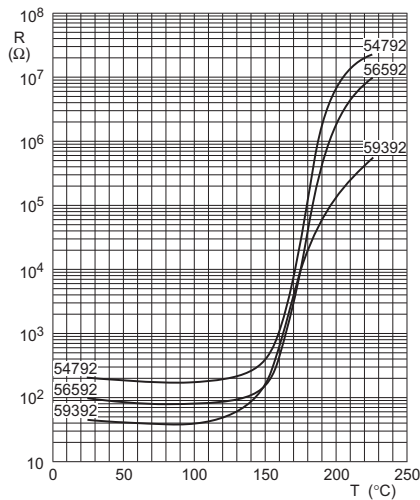

**TYPICAL RESISTANCE/TEMPERATURE  
CHARACTERISTIC** for  
2322 661 52112/52512/52712.

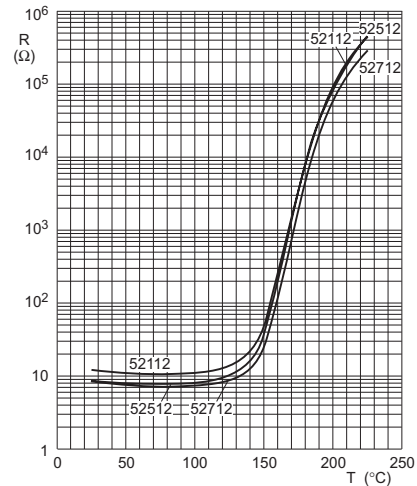

**TYPICAL RESISTANCE/TEMPERATURE  
CHARACTERISTIC** for 2322 660 51112/51312  
and 661 51712.

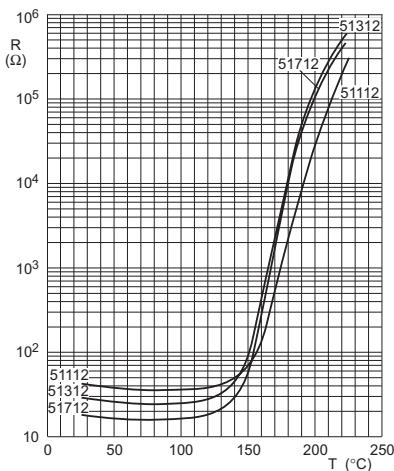

**TYPICAL RESISTANCE/TEMPERATURE  
CHARACTERISTIC** for  
2322 662 53212/53612/54112.

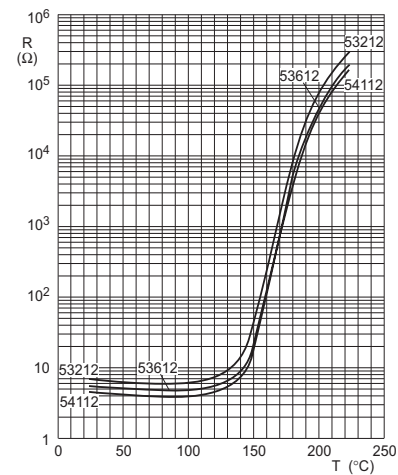



**TYPICAL RESISTANCE/TEMPERATURE CHARACTERISTIC** for 2322 662 54512 and 663 56012/57112.

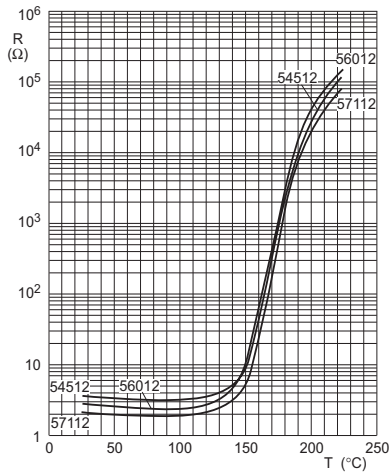

**TYPICAL RESISTANCE/TEMPERATURE CHARACTERISTIC** for 2322 661 54111/54711/55411.

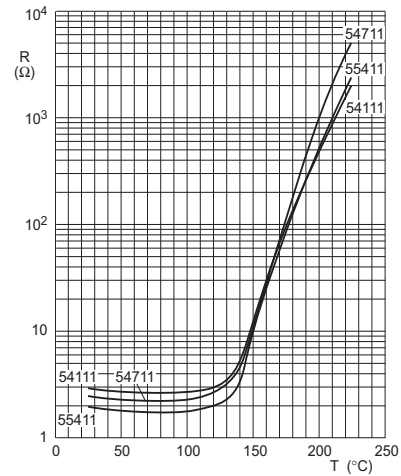

**TYPICAL RESISTANCE/TEMPERATURE CHARACTERISTIC** for 2322 660 51193/51593/51993.

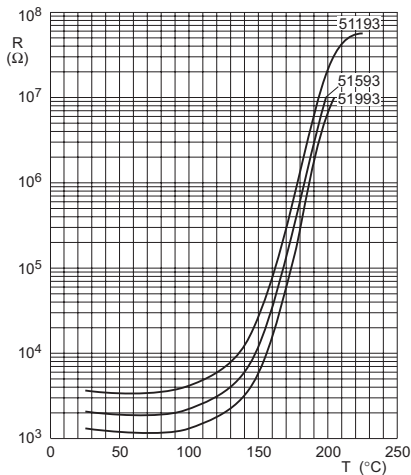

**TYPICAL RESISTANCE/TEMPERATURE CHARACTERISTIC** for 2322 664 58812/51022.

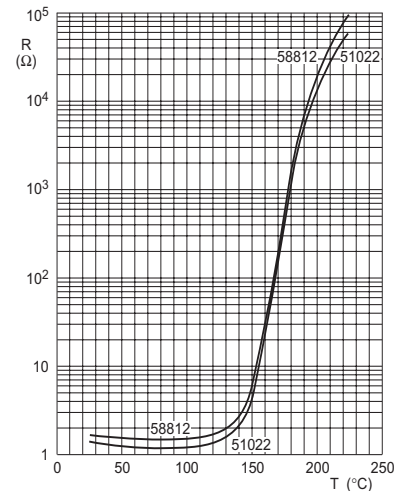

**TYPICAL RESISTANCE/TEMPERATURE CHARACTERISTIC** for 2322 660 57693/59593 and 661 51113.

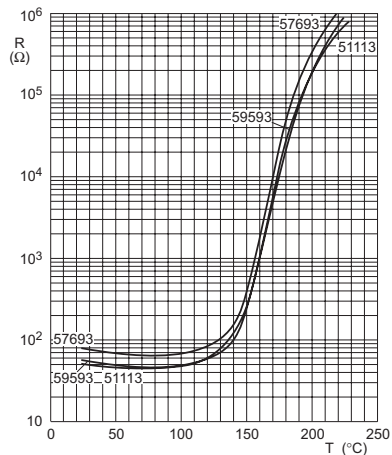

**TYPICAL RESISTANCE/TEMPERATURE CHARACTERISTIC** for 2322 660 52893/53993/56393.

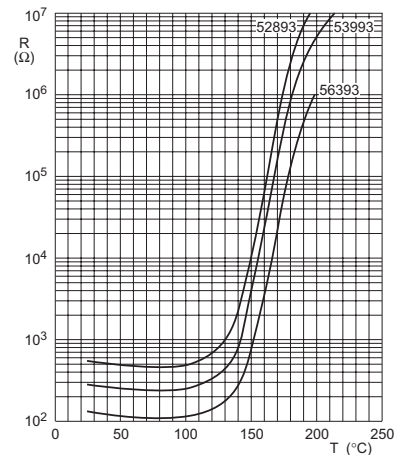



**TYPICAL RESISTANCE/TEMPERATURE CHARACTERISTIC** for 2322 662 52113/52513/52813.

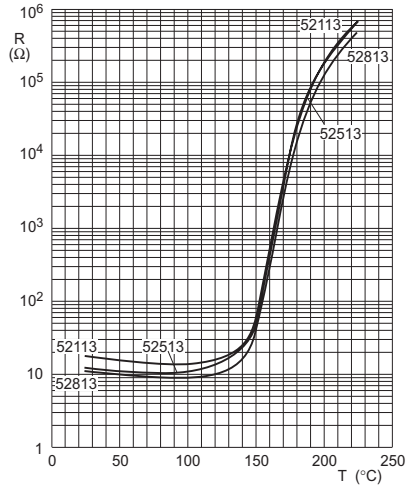

**TYPICAL RESISTANCE/TEMPERATURE CHARACTERISTIC** for 2322 661 51413/51713/51913.

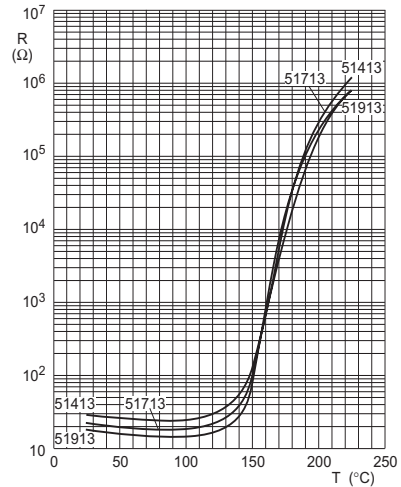

**TYPICAL RESISTANCE/TEMPERATURE CHARACTERISTIC** for 2322 664 55913/57013.

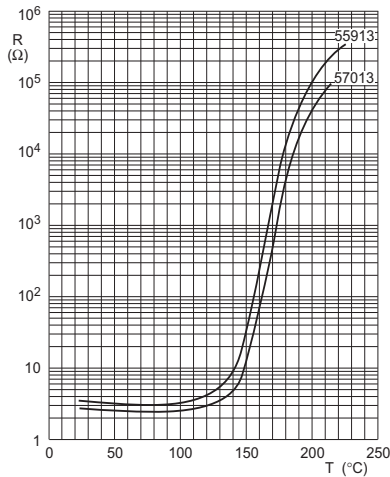

**TYPICAL RESISTANCE/TEMPERATURE CHARACTERISTIC** for 2322 662 53213 and 663 54013/54913.

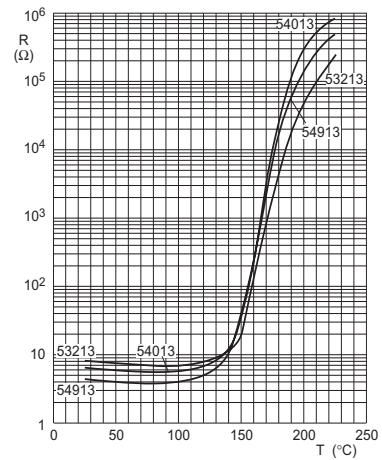

<b>CHARACTERISTICS CONCERNING TAPED THERMISTORS</b>	
<b>PARAMETER</b>	<b>VALUE</b>
Minimum pull out force of the component	5 N
Minimum pull off force of adhesive tape	6 N
Minimum tearing force tape	15 N
Maximum pull off force tape-reel	5 N
Storage conditions	
Storage temperature range	-25 to +40 °C
Maximum relative humidity	80%



**TAPE SPECIFICATIONS** in millimeters

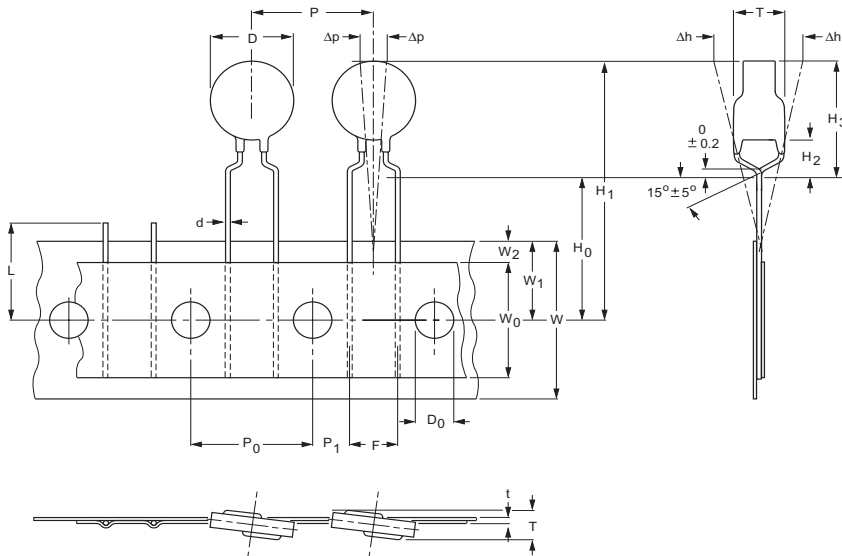

Thermistors on tape for 2322 66. 6...1/2/3.

**REEL SPECIFICATIONS** in millimeters

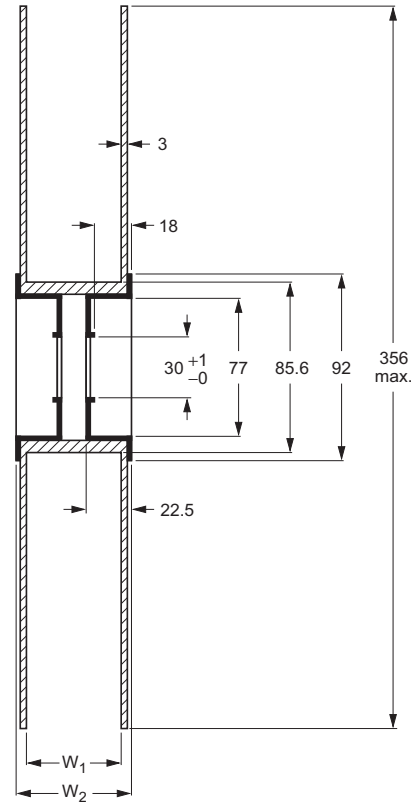

Dimensions of the reel for 2322 66. 6...1/2/3.

<b>REEL DIMENSIONS</b> in millimeters		
DIAMETER Ø	W <sub>1</sub>	W <sub>2</sub> MAX.
<12	42 ±1	56
12	46 ±1	60

**TAPE AND OTHER DEVICE DIMENSIONS IN MILLIMETERS**

SYMBOL	PARAMETER	DIMENSIONS	TOLERANCE	REMARKS
D	body diameter	see Device and Tape Dimensions table	±0.5	
T	total maximum thickness	see Thickness Dimesions table		
d	lead diameter	0.6	±10%	
P	pitch between thermistors:			
	Ø < 12 mm	12.7	±1	
	Ø ≥ 12 mm	25.4	±2	
P <sub>0</sub>	feed hole pitch	12.7	±0.3	cumulative pitch error ±1 mm/20 pitches
P <sub>1</sub>	feed hole centre to lead centre	3.81	±0.7	guaranteed between component and tape
Δh	component alignment	0	±1.3	
F	lead to lead distance	5	+0.6 to -0.1	guaranteed between component and tape
Δh	component alignment	0	±2	
W	tape width	18	+1 to -0.5	
W <sub>0</sub>	hold down tape width	≥12.3	-	
W <sub>1</sub>	hole position	9	±0.5	
W <sub>2</sub>	hold down tape position	≤3.0	-	
H <sub>1</sub>	component height	see Device and Tape Dimensions table		
H <sub>2</sub>	component body to seating plane	4	±1	
H <sub>3</sub>	component top to seating plane	see Device and Tape Dimensions table		
H <sub>0</sub>	lead-wire clinch height	16	±0.5	
D <sub>0</sub>	feed hole diameter	4	±0.2	
t	total tape thickness	≤0.9	-	with cardboard tape 0.5 ±0.1 mm
L	length of snapped lead	≤11	-	