

THIS DRAWING IS UNPUBLISHED. RELEASED FOR PUBLICATION 2011
 © COPYRIGHT 2011 Tyco Electronics AMP GmbH ALL RIGHTS RESERVED.

LOC	DIST	REVISIONS				
P	LTR	DESCRIPTION	DATE	DWN	APVD	
		A2	REVISED	18MAR2013	DC	JC
		A3	RELEASED 293660-3, -5, -6	30SEP2013	DC	JC
		A4	RELEASED 1-293660-1, -2, -3, -5, -6	28FEB2014	KR	JC
		A5	RELEASED 293660-4, 1-4	05MAR2014	KR	JC

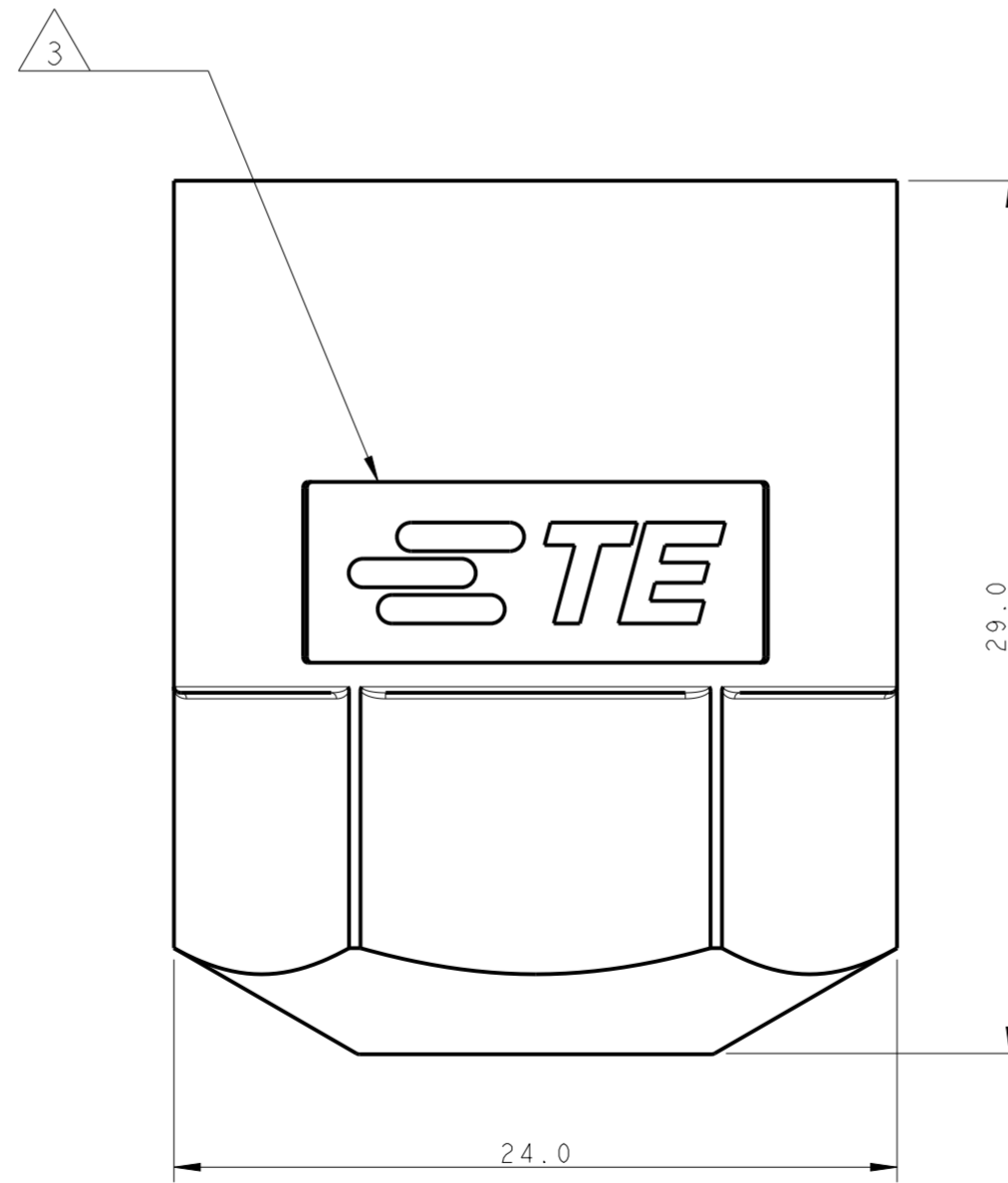

- 1 MATERIAL: PA GF (NATURAL AND BLACK COLOUR)
- 2 NUMBER OF CABLE CORES (n) AND CONDUCTORS SIZE (s.s)
- 3 AREA FOR TE LOGO
- 4 AREA FOR TE P/N

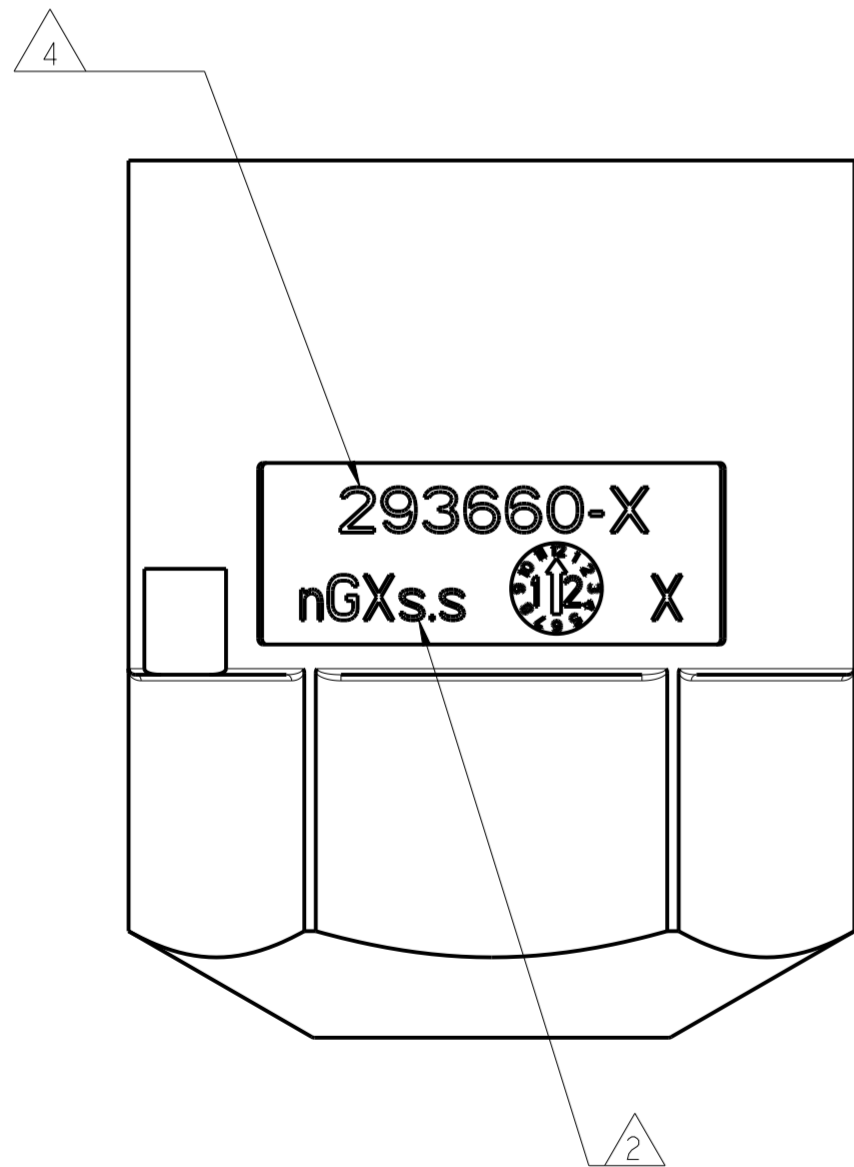
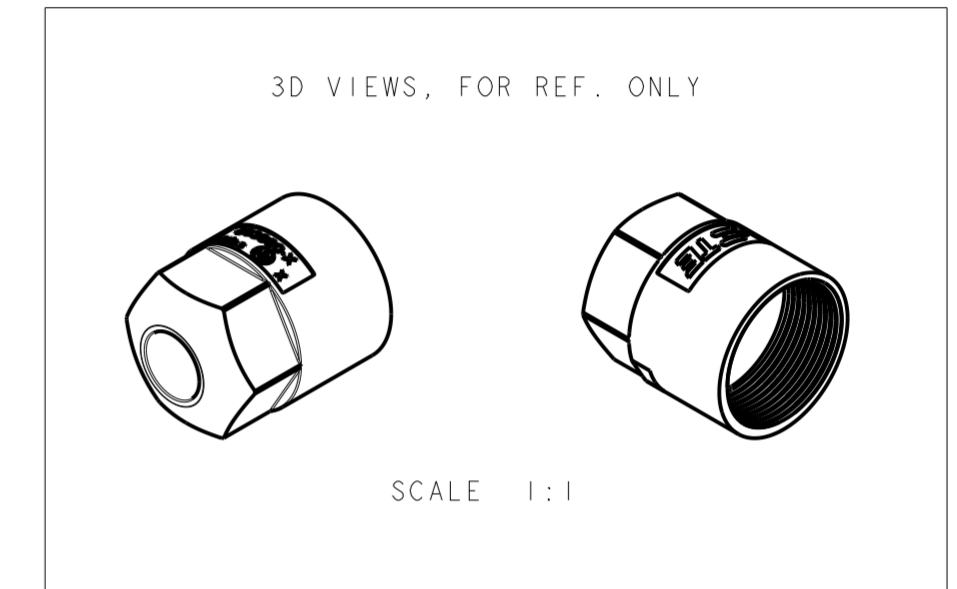

NOTE	DIM "D" NOM.	CABLE OUTSIDE Ø	CABLE TYPE	CONDUCTOR NR. & SIZE (sqmm)	COLOUR	PART NO.	REV.
1	11.30	10.45±0.75	H05VV5-F	5GX1.5	BLACK	1-293660-6	A
1	15.60	14.75±0.75	H05VV5-F	7GX2.5	BLACK	1-293660-5	A
1	7.90	7.60±0.10	RZ1-LSF-OH	-	BLACK	1-293660-4	A
1	13.50	12.65±0.75	H05VV5-F	5GX2.5 7GX1.5	BLACK	1-293660-3	A
1	11.40	11.10±0.10	RZ1-LSF-OH	6GX2.5	BLACK	1-293660-2	A
1	10.00	9.70±0.10	RZ1-LSF-OH	6GX1.5	BLACK	1-293660-1	A
1	11.30	10.45±0.75	H05VV5-F	5GX1.5	NATURAL	293660-6	A
1	15.60	14.75±0.75	H05VV5-F	7GX2.5	NATURAL	293660-5	A
1	7.90	7.60±0.10	RZ1-LSF-OH	-	NATURAL	293660-4	A
1	13.50	12.65±0.75	H05VV5-F	5GX2.5 7GX1.5	NATURAL	293660-3	A
1	11.40	11.10±0.10	RZ1-LSF-OH	6GX2.5	NATURAL	293660-2	A
1	10.00	9.70±0.10	RZ1-LSF-OH	6GX1.5	NATURAL	293660-1	A

THIS DRAWING IS A CONTROLLED DOCUMENT.

DIMENSIONS: mm	TOLERANCES UNLESS OTHERWISE SPECIFIED: 0 PLC ± 1 PLC ±0.3 2 PLC ±0.2 3 PLC ± 4 PLC ± ANGLES ±3° FINISH	DWN A. BERNARDI 21 JAN 2011 CHK U. AIME 21 JAN 2011 APVD G. TURCO 21 JAN 2011	NAME RING NUT FOR CABLE RETENTION (5,6,7 POLES) NECTOR M-LINE UNSEALED VERSION
MATERIAL SEE NOTES	PRODUCT SPEC 108-20324 APPLICATION SPEC 114-20169 WEIGHT -	SIZE A2 CAGE CODE 07779 DRAWING NO C-293660	RESTRICTED TO -

Customer Drawing SCALE 4:1 SHEET 1 OF 1 REV A5