

## MMIC VCO w/ BUFFER AMPLIFIER, 3.55 - 3.9 GHz



### Typical Applications

Low noise MMIC VCO w/Buffer Amplifier for:

- Wireless Local Loop (WLL)
- VSAT & Microwave Radio
- Test Equipment & Industrial Controls
- Military

### Features

- Pout: +4.7 dBm
- Phase Noise: -112 dBc/Hz @100 KHz
- No External Resonator Needed
- Single Supply: 3V @ 42 mA
- QFN Leadless SMT Package, 16 mm<sup>2</sup>

### Functional Diagram

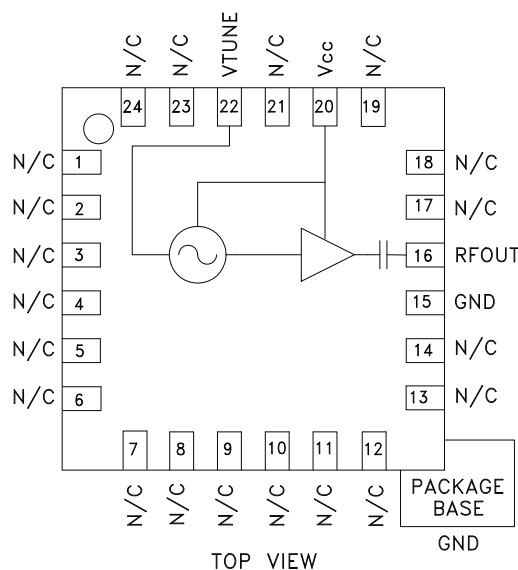

### General Description

The HMC390LP4 & HMC390LP4E are GaAs InGaP Heterojunction Bipolar Transistor (HBT) MMIC VCOs with integrated resonators, negative resistance devices, varactor diodes, and buffer amplifiers. Covering 3.55 to 3.9 GHz, the VCO's phase noise performance is excellent over temperature, shock, vibration and process due to the oscillator's monolithic structure. Power output is 4.7 dBm typical from a single supply of 3V @ 42 mA. The voltage controlled oscillator is packaged in a low cost leadless QFN 4 x 4 mm surface mount package.

### Electrical Specifications, $T_A = +25^\circ\text{C}$ , $V_{CC} = +3\text{V}$

| Parameter   | Min.       | Typ. | Max. | Units                 |
|---|------------|------|------|-----------------------|
| Frequency Range   | 3.55 - 3.9 |      |      | GHz                   |
| Power Output  | 1.5        | 4.7  |      | dBm                   |
| SSB Phase Noise @ 100 kHz Offset, $V_{tune} = +5\text{V}$ @ RF Output |            | -112 |      | dBc/Hz                |
| Tune Voltage ( $V_{tune}$ )   | 0          |      | 10   | V                     |
| Supply Current ( $I_{CC}$ ) ( $V_{CC} = +3.0\text{V}$ )               |            | 42   |      | mA                    |
| Tune Port Leakage Current   |            |      | 10   | $\mu\text{A}$         |
| Output Return Loss  |            | 6    |      | dB                    |
| Harmonics   |            |      |      |                       |
| 2nd   |            | 5    |      | dBc                   |
| 3rd   |            | 16   |      | dBc                   |
| Pulling (into a 2.0:1 VSWR)   |            | 3.3  |      | MHz pp                |
| Pushing @ $V_{tune} = +5\text{V}$                                     |            | -5   |      | MHz/V                 |
| Frequency Drift Rate  |            | 0.4  |      | MHz/ $^\circ\text{C}$ |

Information furnished by Analog Devices is believed to be accurate and reliable. However, no responsibility is assumed by Analog Devices for its use, nor for any infringements of patents or other rights of third parties that may result from its use. Specifications subject to change without notice. No license is granted by implication or otherwise under any patent or patent rights of Analog Devices. Trademarks and registered trademarks are the property of their respective owners.

For price, delivery, and to place orders: Analog Devices, Inc., One Technology Way, P.O. Box 9106, Norwood, MA 02062-9106 Phone: 781-329-4700 • Order online at [www.analog.com](http://www.analog.com) Application Support: Phone: 1-800-ANALOG-D



# HMC390LP4 / 390LP4E

## MMIC VCO w/ BUFFER AMPLIFIER, 3.55 - 3.9 GHz

**Frequency vs. Tuning Voltage, T= 25°C**

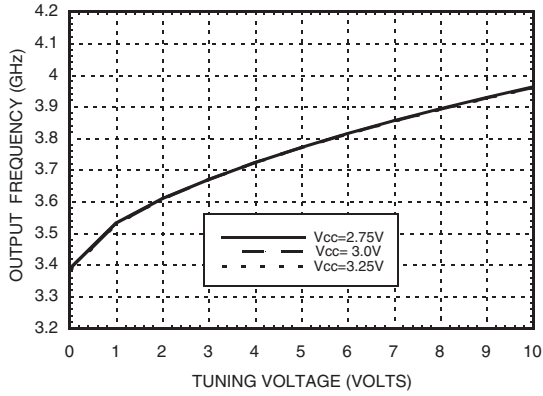

**Frequency vs. Tuning Voltage, Vcc= +3V**

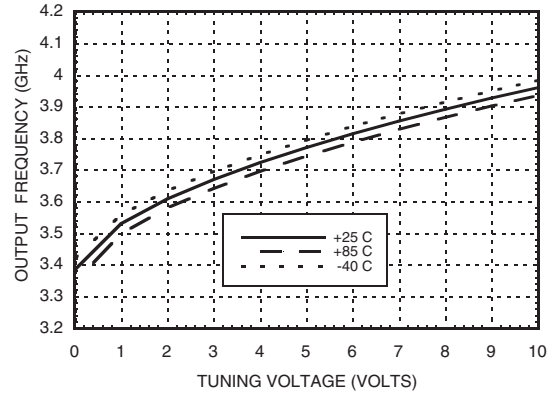

**Sensitivity vs. Tuning Voltage, Vcc= +3V**

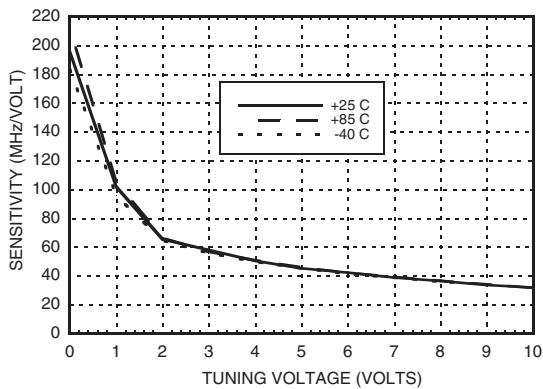

**Output Power vs. Tuning Voltage, Vcc= +3V**

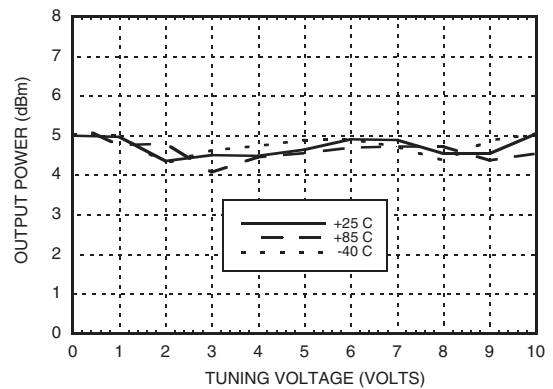

**Phase Noise vs. Tuning Voltage**

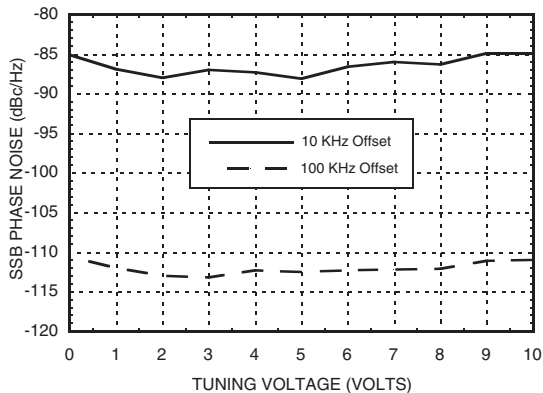

**Typical SSB Phase Noise @ Vtune= +5V**

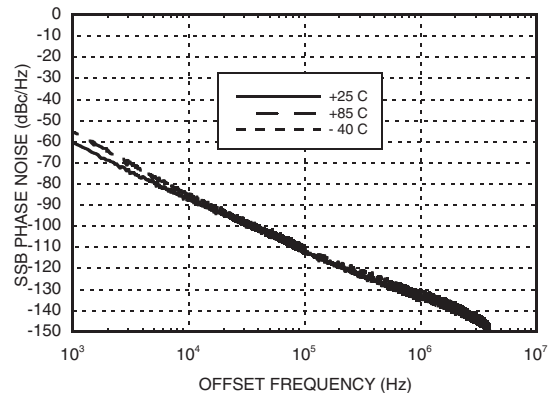

Information furnished by Analog Devices is believed to be accurate and reliable. However, no responsibility is assumed by Analog Devices for its use, nor for any infringements of patents or other rights of third parties that may result from its use. Specifications subject to change without notice. No license is granted by implication or otherwise under any patent or patent rights of Analog Devices. Trademarks and registered trademarks are the property of their respective owners.

For price, delivery, and to place orders: Analog Devices, Inc., One Technology Way, P.O. Box 9106, Norwood, MA 02062-9106 Phone: 781-329-4700 • Order online at [www.analog.com](http://www.analog.com) Application Support: Phone: 1-800-ANALOG-D

## MMIC VCO w/ BUFFER AMPLIFIER, 3.55 - 3.9 GHz



### Absolute Maximum Ratings

|   |                |
|---|----------------|
| Vcc   | +3.5 Vdc       |
| Vtune   | 0 to +11V      |
| Channel Temperature   | 135 °C         |
| Continuous P <sub>diss</sub> (T = 85°C)<br>(derate 6.28 mW/°C above 85°C) | 565 W          |
| Storage Temperature   | -65 to +150 °C |
| Operating Temperature   | -40 to +85 °C  |

### Typical Supply Current vs. Vcc

| Vcc (V) | I <sub>cc</sub> (mA) |
|---------|----------------------|
| 2.75    | 35                   |
| 3.0     | 42                   |
| 3.25    | 47                   |

Note: VCO will operate over full voltage range shown above.



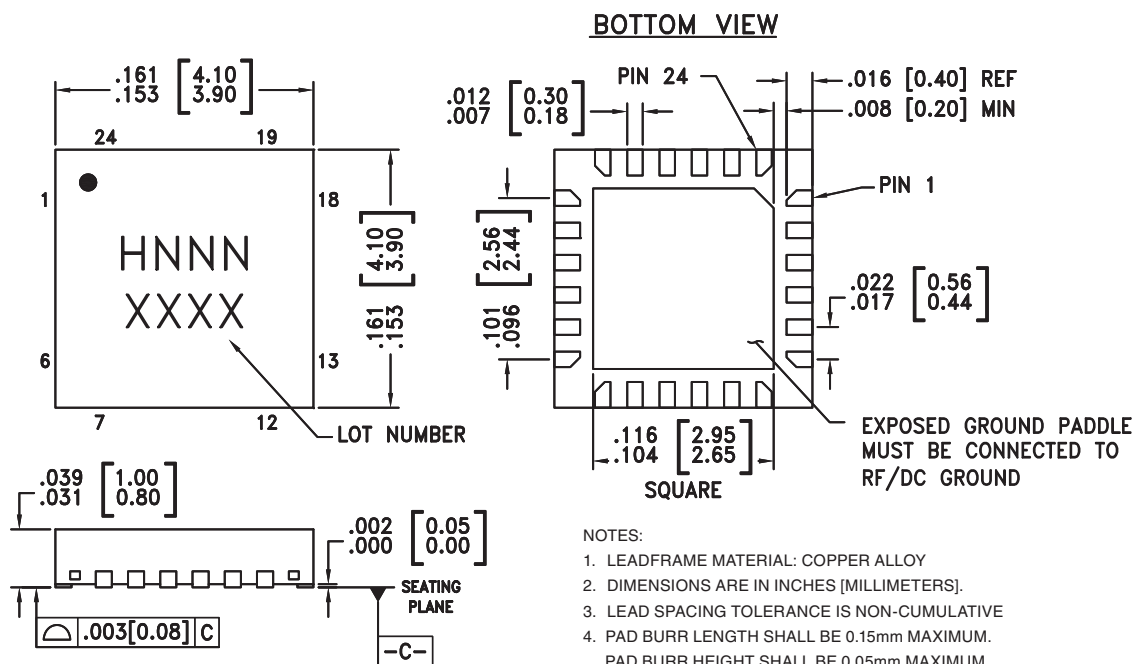

ELECTROSTATIC SENSITIVE DEVICE  
OBSERVE HANDLING PRECAUTIONS

### Outline Drawing



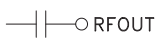
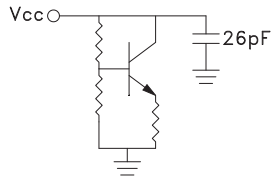
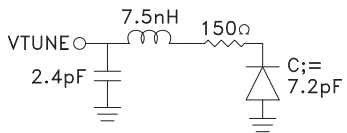

### Pin Descriptions

| Pin Number                 | Function | Description   | Interface Schematic   |
|----------------------------|----------|---|---|
| 1- 14, 17 - 19, 21, 23, 24 | N/C      | No Connection   |   |
| 15                         | GND      | This pin must be connected to RF & DC ground.   |    |
| 16                         | RFOUT    | RF output (AC coupled)  |    |
| 20                         | Vcc      | Supply Voltage Vcc= 3V  |    |
| 22                         | VTUNE    | Control Voltage Input. Modulation port bandwidth dependent on drive source impedance. |   |
|                            | GND      | Package bottom has an exposed metal paddle that must be RF & DC grounded.             |  |

Information furnished by Analog Devices is believed to be accurate and reliable. However, no responsibility is assumed by Analog Devices for its use, nor for any infringements of patents or other rights of third parties that may result from its use. Specifications subject to change without notice. No license is granted by implication or otherwise under any patent or patent rights of Analog Devices. Trademarks and registered trademarks are the property of their respective owners.

For price, delivery, and to place orders: Analog Devices, Inc., One Technology Way, P.O. Box 9106, Norwood, MA 02062-9106 Phone: 781-329-4700 • Order online at [www.analog.com](http://www.analog.com) Application Support: Phone: 1-800-ANALOG-D



**Evaluation PCB**

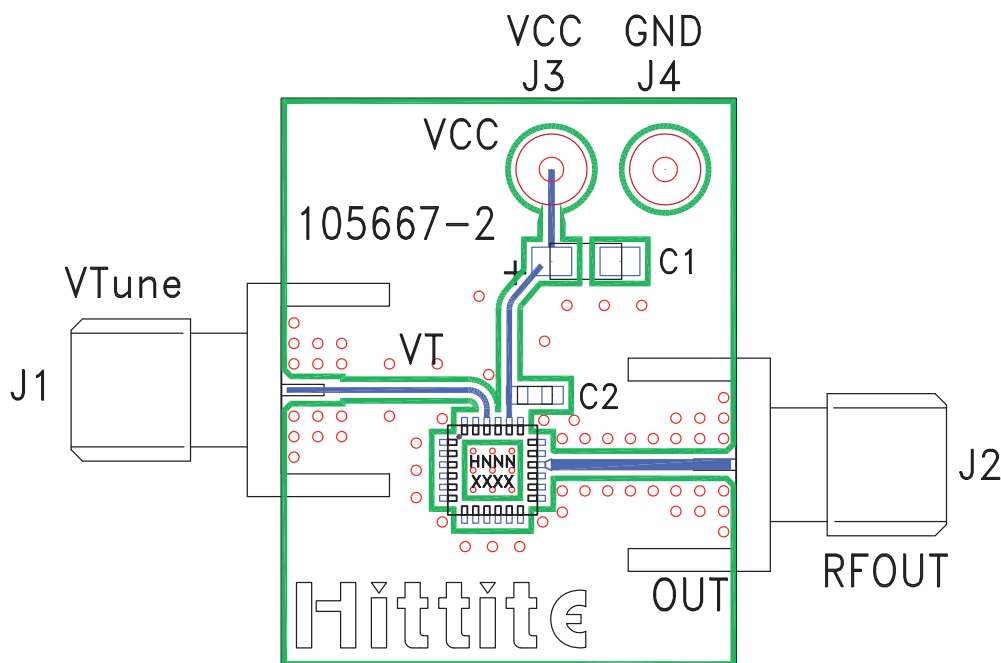

**List of Materials for Evaluation PCB 105706 [1]**

| Item    | Description                    |
|---------|--------------------------------|
| J1 - J2 | PCB Mount SMA RF Connector     |
| J3 - J4 | DC Pin                         |
| C1      | 4.7 μF Tantalum Capacitor      |
| C2      | 10,000 pF Capacitor, 0603 Pkg. |
| U1      | HMC390LP4 / HMC390LP4E VCO     |
| PCB*    | 105667 Eval Board              |

[1] Reference this number when ordering complete evaluation PCB

[2] Circuit Board Material: Rogers 4350

The circuit board used in the final application should use RF circuit design techniques. Signal lines should have 50 ohm impedance while the package ground leads and exposed paddle should be connected directly to the ground plane similar to that shown. A sufficient number of via holes should be used to connect the top and bottom ground planes. The evaluation circuit board shown is available from Hittite upon request.



**Notes:**

v02.0505

## HMC390LP4 / 390LP4E

**MMIC VCO w/ BUFFER  
AMPLIFIER, 3.55 - 3.9 GHz**