

SMA ATTENUATOR
16 DB 18 GHZ 2W

R411.816.121
Series : ATTENUATOR

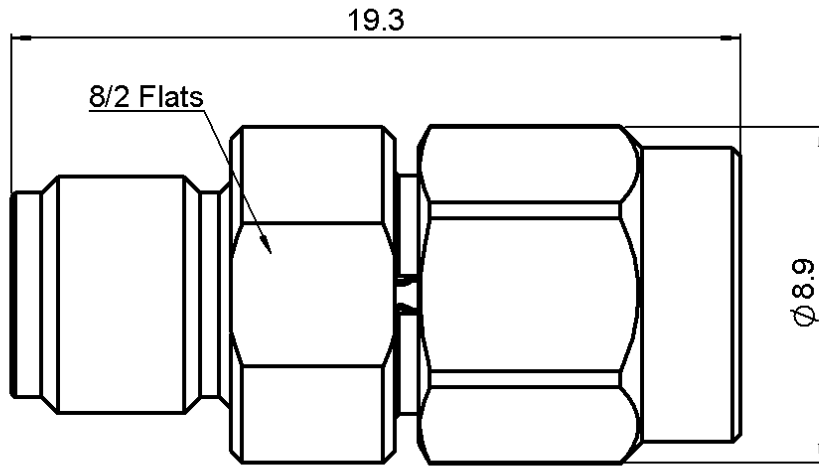

SCALE 1/1



All dimensions are in mm.

COMPONENTS	MATERIALS	PLATING(μm)
BODY	STAINLESS STEEL	PASSIVATION
MALE CENTER CONTACT	BERYLLIUM COPPER	GOLD 2.5 OVER NICKEL 1
FEMALE CENTER CONTACT	BERYLLIUM COPPER	GOLD 2.5 OVER NICKEL 2
OUTER CONTACT		
INSULATOR	PTFE	
GASKET	SILICONE RUBBER	
SUBSTRATE	ALUMINA	
RESISTOR	THIN FILM	
OTHERS PARTS		

Issue : 0835 C

In the effort to improve our products, we reserve the right to make changes judged to be necessary.

SMA ATTENUATOR
16 DB 18 GHZ 2W

R411.816.121
Series : ATTENUATOR

ELECTRICAL CHARACTERISTICS

Frequency (GHz)	DC - 4	4 - 8	8 - 12.4	12.4 - 18
V.S.W.R (≤)	1.15	1.20	1.25	1.35
Deviation(±dB)	0.50	0.50	0.60	1.00

Operating Frequency Range	DC - 18	GHz
Impedance	50	Ω
Nominal Attenuation	16	dB
Peak power at 25°C (1μs, 1%)	100	W
Average power at 25°C	2	W (Free Air Cooled)
		W (Conduction Cooled)

MECHANICAL CHARACTERISTICS

Connectors	SMA	Male Female	MIL-C 39012
Weight	4,5810 g		

ENVIRONMENTAL CHARACTERISTICS

Operating temperature range	-55 /+125 °C
Storage temperature range	-55 /+125 °C

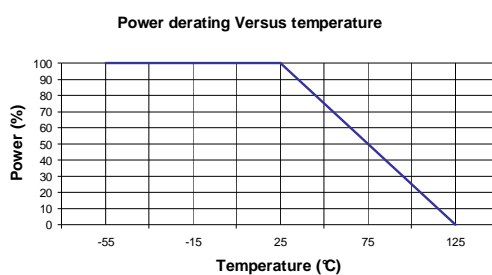

SPECIFICATION

OTHER CHARACTERISTICS

Issue : 0835 C

In the effort to improve our products, we reserve the right to make changes judged to be necessary.

