

## ISL28191, ISL28291

Single and Dual Single Supply Ultra-Low Noise, Low Distortion Rail-to-Rail Output, Op Amp

FN6156  
Rev 10.00  
July 22, 2014

The ISL28191 and ISL28291 are tiny single and dual ultra-low noise, ultra-low distortion operational amplifiers. They are fully specified to operate down to +3V single supply. These amplifiers have outputs that swing rail-to-rail and an input common mode voltage that extends to ground (ground sensing).

The ISL28191 and ISL28291 are unity gain stable with an input referred voltage noise of 1.7nV/√Hz. Both parts feature 0.00018% THD+N at 1kHz.

The ISL28191 is available in the space-saving 6 Ld UTDFN (1.6mmx1.6mm) and 6 Ld SOT-23 packages. The ISL28291 is available in the 8 Ld SOIC, 10 Ld 1.8mmx1.4mm UTQFN and 10 Ld MSOP packages. All devices are guaranteed over -40 °C to +125 °C.

### Ordering Information

PART NUMBER (Note 5)	PART MARKING	PACKAGE (Pb-free)	PKG. DWG. #
ISL28191FHZ-T7 (Notes 1, 2)	GABJ (Note 4)	6 Ld SOT-23	P6.064A
ISL28191FRUZ-T7 (Notes 1, 3)	M8	6 Ld UTDFN	L6.1.6x1.6A
ISL28291FUZ (Note 2)	8291Z	10 Ld MSOP	M10.118A
ISL28291FUZ-T7 (Notes 1, 2)	8291Z	10 Ld MSOP	M10.118A
ISL28291FBZ (Note 2)	28291 FBZ	8 Ld SOIC	M8.15E
ISL28291FBZ-T7 (Notes 1, 2)	28291 FBZ	8 Ld SOIC	M8.15E
ISL28291FRUZ-T7 (Notes 1, 3)	F	10 Ld UTQFN	L10.1.8x1.4A
ISL28191EVAL1Z	Evaluation Board		
ISL28291EVAL1Z	Evaluation Board		

#### NOTES:

- Please refer to [TB347](#) for details on reel specifications.
- These Intersil Pb-free plastic packaged products employ special Pb-free material sets, molding compounds/die attach materials, and 100% matte tin plate plus anneal (e3 termination finish, which is RoHS compliant and compatible with both SnPb and Pb-free soldering operations). Intersil Pb-free products are MSL classified at Pb-free peak reflow temperatures that meet or exceed the Pb-free requirements of IPC/JEDEC J STD-020.
- These Intersil Pb-free plastic packaged products employ special Pb-free material sets; molding compounds/die attach materials and NiPdAu plate - e4 termination finish, which is RoHS compliant and compatible with both SnPb and Pb-free soldering operations. Intersil Pb-free products are MSL classified at Pb-free peak reflow temperatures that meet or exceed the Pb-free requirements of IPC/JEDEC J STD-020.
- The part marking is located on the bottom of the part.
- For Moisture Sensitivity Level (MSL), please see device information page for [ISL28191](#), [ISL28291](#). For more information on MSL please see techbrief TB363.

### Features

- 1.7nV/√Hz input voltage noise at 1kHz
- 1kHz THD+N typical 0.00018% at 2V<sub>P-P</sub> V<sub>OUT</sub>
- Harmonic Distortion -76dBc, -70dBc, f<sub>0</sub> = 1MHz
- 61MHz -3dB bandwidth
- 630μV maximum offset voltage
- 3μA input bias current
- 100dB typical CMRR
- 3V to 5.5V single supply voltage range
- Rail-to-rail output
- Ground Sensing
- Enable pin (not available in the 8 Ld SOIC package option)
- Pb-free (RoHS compliant)

### Applications

- Low noise signal processing
- Low noise microphones/preamplifiers
- ADC buffers
- DAC output amplifiers
- Digital scales
- Strain gauges/sensor amplifiers
- Radio systems
- Portable equipment
- Infrared detectors

### Related Literature

- [AN1343](#): ISL2829xEVAL1Z, ISL5529xEVAL1Z Evaluation Board User's Guide

# Pin Configurations

ISL28191  
(6 LD SOT-23)  
TOP VIEW

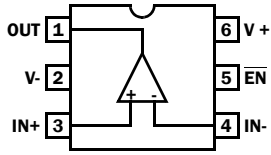

ISL28191  
(6 LD 1.6X1.6X0.5 UTDFN)  
TOP VIEW

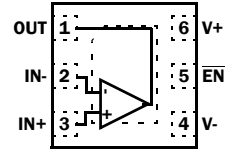

ISL28291  
(8 LD SOIC)  
TOP VIEW

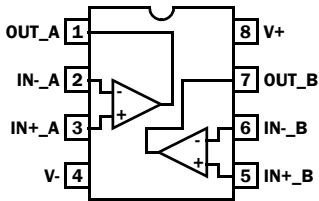

ISL28291  
(10 LD MSOP)  
TOP VIEW

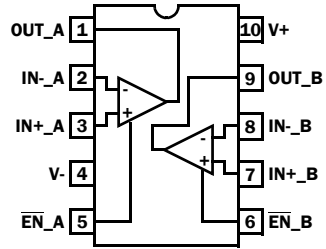

ISL28291  
(10 LD UTQFN)  
TOP VIEW

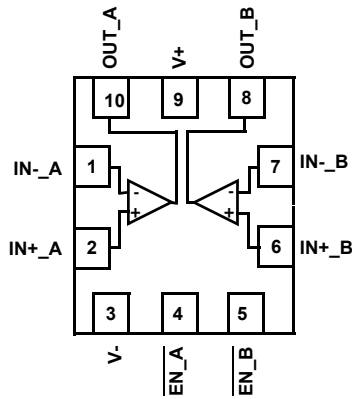

## Pin Descriptions

ISL28191 (6 Ld SOT-23)	ISL28191 (6 Ld UTDFN)	ISL28291 (8 Ld SOIC)	ISL28291 (10 Ld MSOP)	ISL28291 (10 Ld UTQFN)	PIN NAME	FUNCTION	EQUIVALENT CIRCUIT
4	2	2 (A) 6 (B)	2 (A) 8 (B)	1 (A) 7 (B)	IN- IN-_A IN-_B	Inverting input	<p>Circuit 1</p>
3	3	3 (A) 5 (B)	3 (A) 7 (B)	2 (A) 6 (B)	IN+ IN+_A IN+_B	Non-inverting input	(See circuit 1)
2	4	4	4	3	V-	Negative supply	
1	1	1 (A) 7 (B)	1 (A) 9 (B)	10 (A) 8 (B)	OUT OUT_A OUT_B	Output	<p>Circuit 2</p>
6	6	8	10	9	V+	Positive supply	
5	5	N/A	5 (A) 6 (B)	4 (A) 5 (B)	$\overline{EN}$ $\overline{EN}_A$ $\overline{EN}_B$	Enable BAR pin internal pull-down; Logic "1" selects the disabled state; Logic "0" selects the enabled state.	<p>Circuit 3</p>

**Absolute Maximum Ratings** ( $T_A = +25^\circ\text{C}$ )

Supply Voltage	5.5V
Supply Turn On Voltage Slew Rate	1V/ $\mu\text{s}$
Differential Input Current	5mA
Differential Input Voltage	0.5V
Input Voltage	V-- 0.5V to V+ + 0.5V
ESD Tolerance	
Human Body Model	3kV
Machine Model	300V
Charged Device Model (CDM)	1200V

**Thermal Information**

Thermal Resistance (Typical)	$\theta_{JA}$ ( $^\circ\text{C}/\text{W}$ )	$\theta_{JC}$ ( $^\circ\text{C}/\text{W}$ )
6 Ld SOT-23 Package (Notes 6, 9)	170	105
6 Ld UTDFN Package (Notes 7, 8)	125	80
8 Ld SOIC Package (Notes 6, 9)	110	82
10 Ld MSOP Package (Notes 6, 9)	175	90
10 Ld UTQFN Package (Notes 6, 9)	190	140
Storage Temperature Range	-65 $^\circ\text{C}$ to +150 $^\circ\text{C}$	
Pb-Free Reflow Profile	see link below <a href="http://www.intersil.com/pbfree/Pb-FreeReflow.asp">http://www.intersil.com/pbfree/Pb-FreeReflow.asp</a>	

**Operating Conditions**

Ambient Operating Temperature Range	-40 $^\circ\text{C}$ to +125 $^\circ\text{C}$
Maximum Operating Junction Temperature	+125 $^\circ\text{C}$
Supply Voltage	.3V to 5.5V

**CAUTION:** Do not operate at or near the maximum ratings listed for extended periods of time. Exposure to such conditions may adversely impact product reliability and result in failures not covered by warranty.

**NOTE:**

- $\theta_{JA}$  is measured with the component mounted on a high effective thermal conductivity test board in free air. See Tech Brief [TB379](#) for details.
- $\theta_{JA}$  is measured in free air with the component mounted on a high effective thermal conductivity test board with "direct attach" features. See Tech Brief [TB379](#).
- For  $\theta_{JC}$ , the "case temp" location is the center of the exposed metal pad on the package underside.
- For  $\theta_{JC}$ , the "case temp" location is taken at the package top center.

**Electrical Specifications** V+ = 5.0V, V- = GND,  $R_L = \text{Open}$ ,  $R_F = 1\text{k}\Omega$ ,  $A_V = -1$  unless otherwise specified. Parameters are per amplifier. Typical values are at V+ = 5V,  $T_A = +25^\circ\text{C}$ . **Boldface limits apply over the operating temperature range, -40 $^\circ\text{C}$  to +125 $^\circ\text{C}$ .**

PARAMETER	DESCRIPTION	CONDITIONS	MIN (Note 10)	TYP	MAX (Note 10)	UNIT
<b>DC SPECIFICATIONS</b>						
$V_{OS}$	Input Offset Voltage			270	630 <b>840</b>	$\mu\text{V}$
$\frac{\Delta V_{OS}}{\Delta T}$	Input Offset Drift vs Temperature	Figure 21		3.1		$\mu\text{V}/^\circ\text{C}$
$I_{IO}$	Input Offset Current			35	500 <b>900</b>	nA
$I_B$	Input Bias Current			3	6 <b>7</b>	$\mu\text{A}$
CMIR	Common-Mode Input Range		<b>0</b>		<b>3.8</b>	V
CMRR	Common-Mode Rejection Ratio	$V_{CM} = 0\text{V}$ to 3.8V	<b>78</b>	100		dB
PSRR	Power Supply Rejection Ratio	$V_S = 3\text{V}$ to 5V	<b>74</b>	80		dB
$A_{VOL}$	Large Signal Voltage Gain	$V_O = 0.5\text{V}$ to 4V, $R_L = 1\text{k}\Omega$	90 <b>86</b>	98		dB
$V_{OUT}$	Maximum Output Voltage Swing	Output low, $R_L = 1\text{k}\Omega$		20	50 <b>80</b>	mV
		Output high, $R_L = 1\text{k}\Omega$ , V+ = 5V	4.95 <b>4.92</b>	4.97		V
$I_{S,ON}$	Supply Current per Amplifier, Enabled			2.6	3.5 <b>3.9</b>	mA
$I_{S,OFF}$	Supply Current per Amplifier, Disabled			26	35 <b>48</b>	$\mu\text{A}$
$I_{O+}$	Short-Circuit Output Current	$R_L = 10\Omega$	95	130		mA
			<b>90</b>			

**Electrical Specifications**  $V_+ = 5.0V$ ,  $V_- = GND$ ,  $R_L = \text{Open}$ ,  $R_F = 1k\Omega$ ,  $A_V = -1$  unless otherwise specified. Parameters are per amplifier. Typical values are at  $V_+ = 5V$ ,  $T_A = +25^\circ C$ . **Boldface limits apply over the operating temperature range,  $-40^\circ C$  to  $+125^\circ C$ .** (Continued)

PARAMETER	DESCRIPTION	CONDITIONS	MIN (Note 10)	TYP	MAX (Note 10)	UNIT
$I_{O-}$	Short-Circuit Output Current	$R_L = 10\Omega$	95	130		mA
			<b>90</b>			
$V_{SUPPLY}$	Supply Operating Range	$V_+$ to $V_-$	3		5.5	V
$V_{ENH}$	$\overline{EN}$ High Level	Referred to $V_-$	2			V
$V_{ENL}$	$\overline{EN}$ Low Level	Referred to $V_-$			0.8	V
$I_{ENH}$	$\overline{EN}$ Pin Input High Current	$V_{\overline{EN}} = V_+$		0.8	1.1	$\mu A$
					<b>1.3</b>	
$I_{ENL}$	$\overline{EN}$ Pin Input Low Current	$V_{\overline{EN}} = V_-$		20	80	nA
					<b>100</b>	
<b>AC SPECIFICATIONS</b>						
GBW	-3dB Unity Gain Bandwidth	$R_F = 0\Omega$ , $C_L = 20pF$ , $A_V = 1$ , $R_L = 10k\Omega$		61		MHz
THD+N	Total Harmonic Distortion + Noise	$f = 1kHz$ , $V_{OUT} + 2V_{P-P}$ , $A_V = +1$ , $R_L = 10k\Omega$		0.0001		%
				8		
HD (1MHz)	2nd Harmonic Distortion	$2V_{P-P}$ output voltage, $A_V = 1$		-76		dBc
	3rd Harmonic Distortion			-70		dBc
ISO	Off-state Isolation $f_0 = 100kHz$	$A_V = +1$ , $V_{IN} = 100mV_{P-P}$ , $R_F = 0\Omega$ $C_L = 20pF$ , $A_V = 1$ , $R_L = 10k\Omega$		-38		dB
X-TALK ISL28291	Channel-to-Channel Crosstalk $f_0 = 100kHz$	$V_S = \pm 2.5V$ , $A_V = +1$ , $V_{IN} = 1V_{P-P}$ , $R_F = 0\Omega$ , $C_L = 20pF$ , $A_V = 1$ , $R_L = 10k\Omega$		-105		dB
PSRR	Power Supply Rejection Ratio $f_0 = 100kHz$	$V_S = \pm 2.5V$ , $A_V = +1$ , $V_{SOURCE} = 1V_{P-P}$ , $R_F = 0\Omega$ , $C_L = 20pF$ , $A_V = 1$ , $R_L = 10k\Omega$		-70		dB
CMRR	Common Mode Rejection Ratio $f_0 = 100kHz$	$V_S = \pm 2.5V$ , $A_V = +1$ , $V_{CM} = 1V_{P-P}$ , $R_F = 0\Omega$ , $C_L = 20pF$ , $A_V = 1$ , $R_L = 10k\Omega$		-65		dB
$e_n$	Input Referred Voltage Noise	$f_0 = 1kHz$		1.7		$nV/\sqrt{Hz}$
$i_n$	Input Referred Current Noise	$f_0 = 1kHz$		1.8		$pA/\sqrt{Hz}$
<b>TRANSIENT RESPONSE</b>						
SR	Slew Rate		12	17		$V/\mu s$
			<b>12</b>			
$t_r, t_f$ , Small Signal	Rise Time, $t_r$ 10% to 90%	$A_V = 1$ , $V_{OUT} = 0.1V_{P-P}$ , $R_L = 10k\Omega$ , $C_L = 1.2pF$		7		ns
	Fall Time, $t_f$ 90% to 10%			12		ns
$t_r, t_f$ Large Signal	Rise Time, $t_r$ 10% to 90%	$A_V = 2$ , $V_{OUT} = 1V_{P-P}$ ; $R_L = 10k\Omega$ , $R_F/R_G = 499\Omega/499\Omega$ , $C_L = 1.2pF$		44		ns
	Fall Time, $t_f$ 90% to 10%			50		ns
	Rise Time, $t_r$ 10% to 90%	$A_V = 2$ , $V_{OUT} = 4.7V_{P-P}$ ; $R_L = 10k\Omega$ , $R_F/R_G = 499\Omega/499\Omega$ , $C_L = 1.2pF$		190		ns
	Fall Time, $t_f$ 90% to 10%			190		ns
$t_{EN}$	ENABLE to Output Turn-on Delay Time; 10% $\overline{EN}$ - 10% $V_{OUT}$	$A_V = 1$ , $V_{OUT} = 1V_{DC}$ , $R_L = 10k\Omega$ , $C_L = 1.2pF$		330		ns
	ENABLE to Output Turn-off Delay Time; 10% $\overline{EN}$ - 10% $V_{OUT}$	$A_V = 1$ , $V_{OUT} = 0V_{DC}$ , $R_L = 10k\Omega$ , $C_L = 1.2pF$		50		ns

## NOTE:

10. Compliance to datasheet limits is assured by one or more methods: production test, characterization and/or design.

## Typical Performance Curves

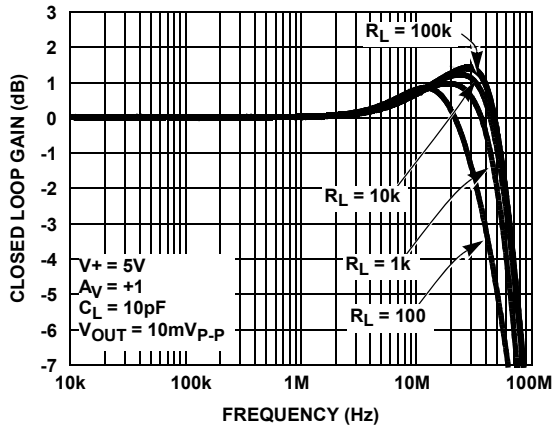

FIGURE 1. GAIN vs FREQUENCY FOR VARIOUS  $R_{LOAD}$

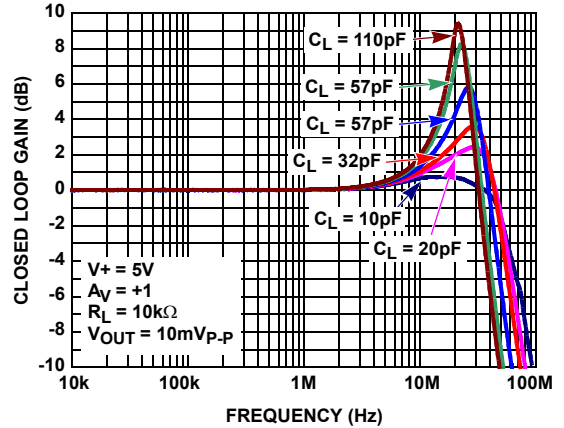

FIGURE 2. GAIN vs FREQUENCY FOR VARIOUS  $C_{LOAD}$

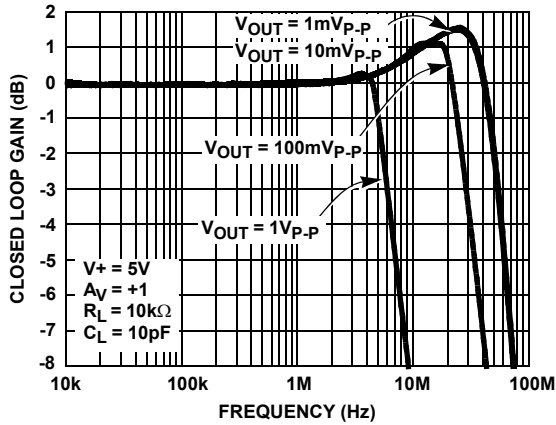

FIGURE 3. -3dB BANDWIDTH vs  $V_{OUT}$

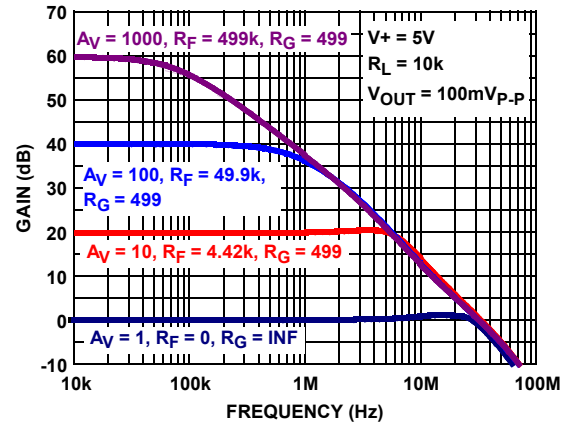

FIGURE 4. FREQUENCY RESPONSE vs CLOSED LOOP GAIN

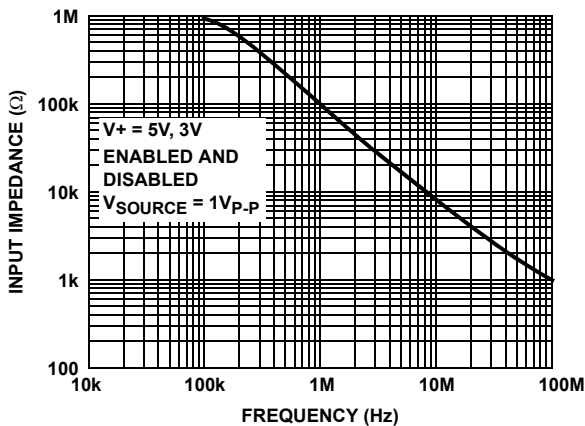

FIGURE 5. INPUT IMPEDANCE vs FREQUENCY

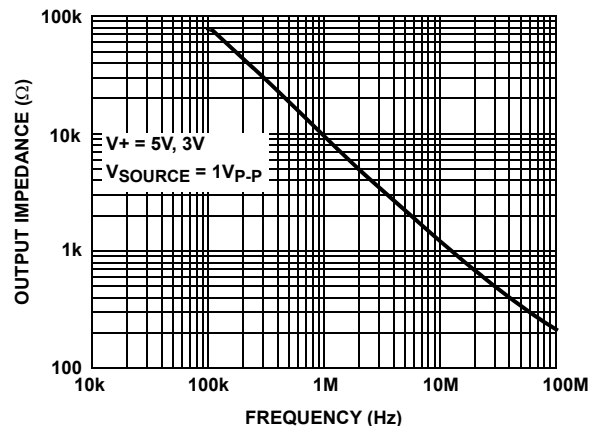

FIGURE 6. DISABLED OUTPUT IMPEDANCE vs FREQUENCY

## Typical Performance Curves (Continued)

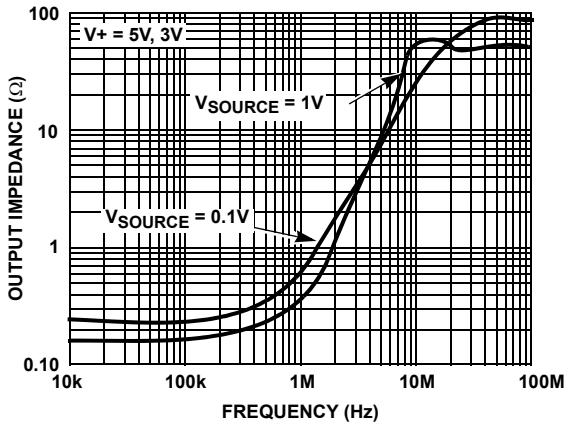

FIGURE 7. ENABLED OUTPUT IMPEDANCE vs FREQUENCY

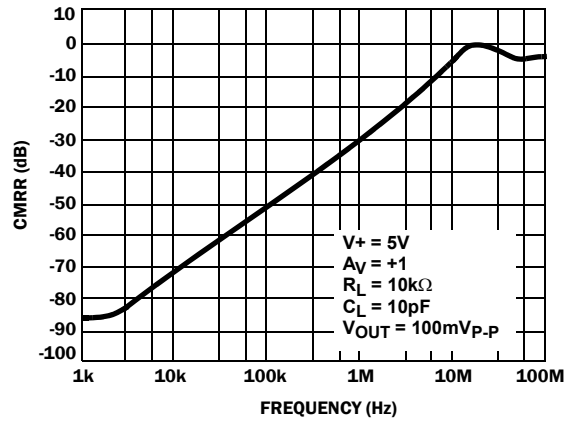

FIGURE 8. CMRR vs FREQUENCY

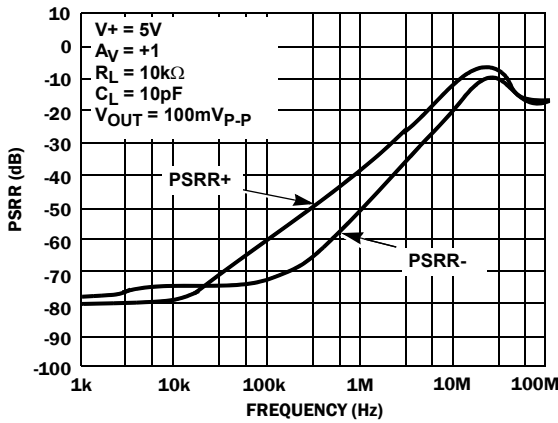

FIGURE 9. PSRR vs FREQUENCY

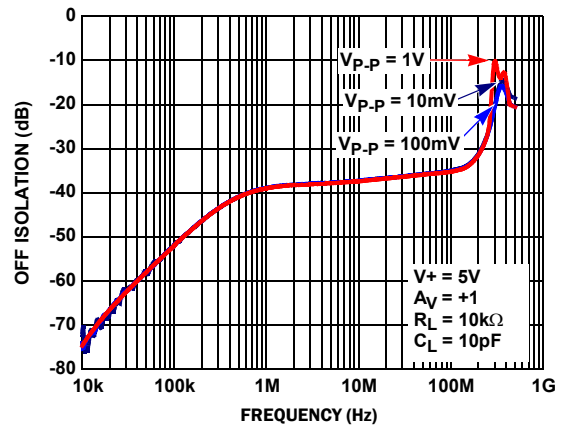

FIGURE 10. OFF ISOLATION vs FREQUENCY

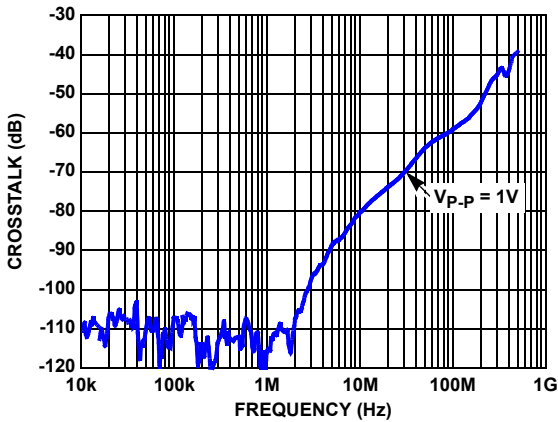

FIGURE 11. CHANNEL TO CHANNEL CROSSTALK vs FREQUENCY

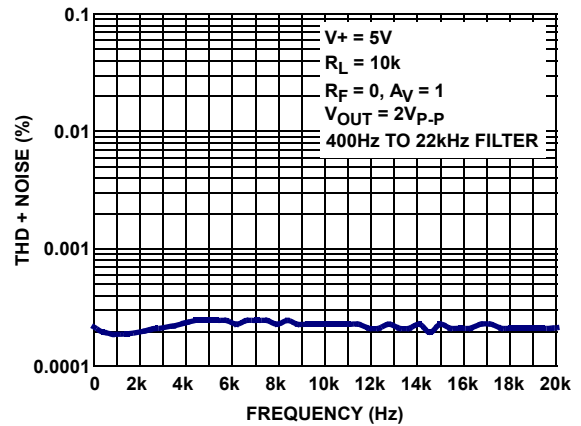

FIGURE 12. THD+N vs FREQUENCY

## Typical Performance Curves (Continued)

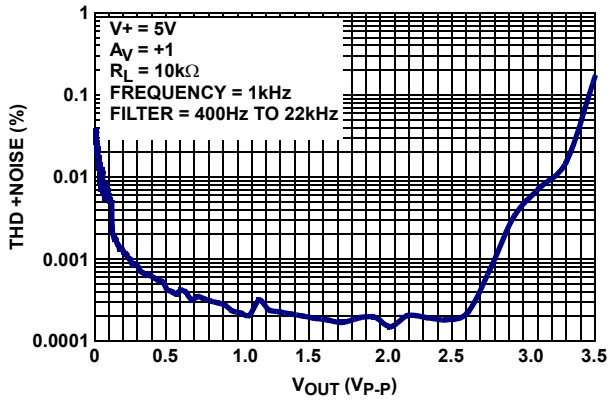

FIGURE 13. THD+N @ 1kHz vs  $V_{OUT}$

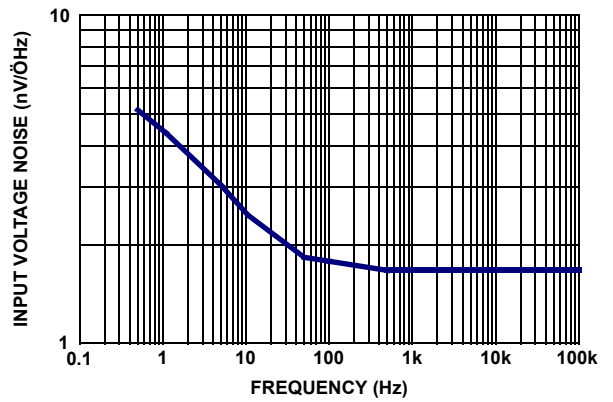

FIGURE 14. INPUT REFERRED NOISE VOLTAGE vs FREQUENCY

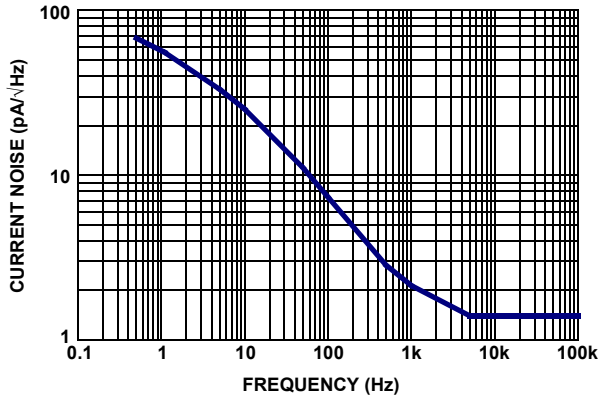

FIGURE 15. INPUT REFERRED NOISE CURRENT vs FREQUENCY

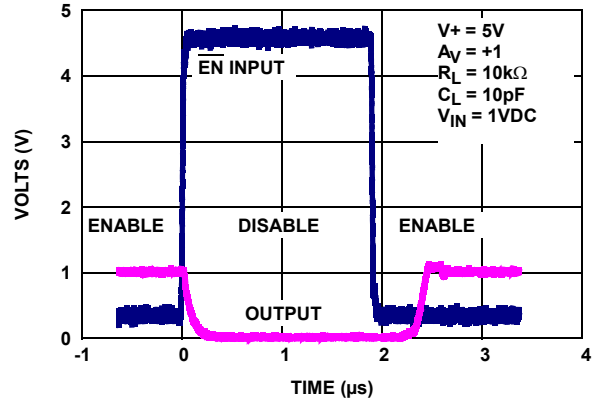

FIGURE 16. ENABLE/DISABLE TIMING

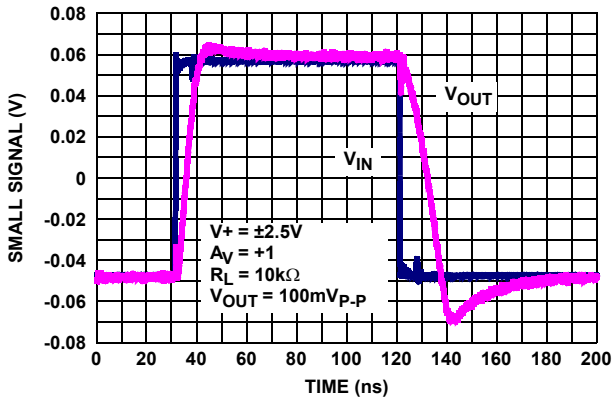

FIGURE 17. SMALL SIGNAL STEP RESPONSE

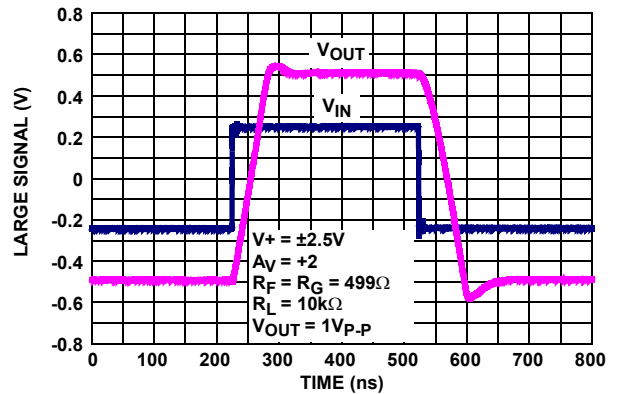

FIGURE 18. LARGE SIGNAL (1V) STEP RESPONSE



## Typical Performance Curves (Continued)

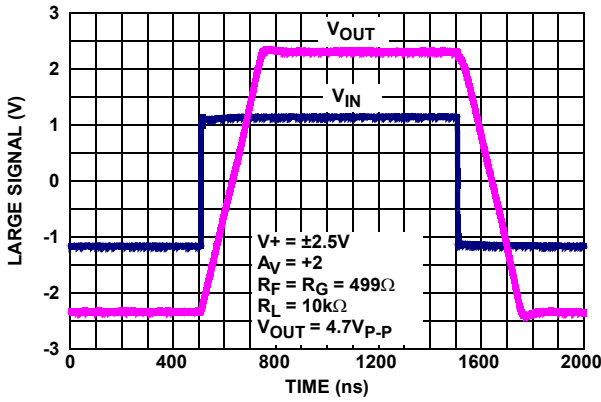

FIGURE 19. LARGE SIGNAL (4.7V) STEP RESPONSE

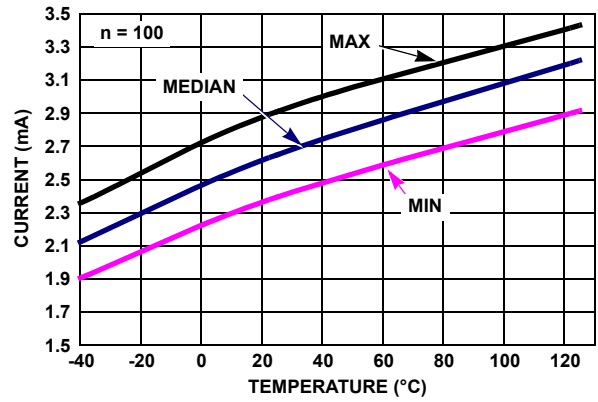

FIGURE 20. SUPPLY CURRENT vs TEMPERATURE,  $V_S = \pm 2.5V$  ENABLED,  $R_L = \text{INF}$

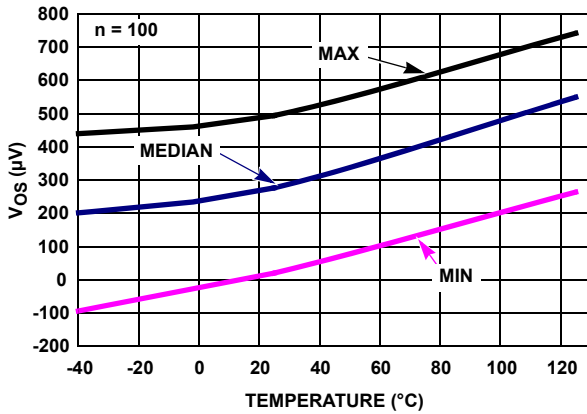

FIGURE 21.  $V_{OS}$  vs TEMPERATURE,  $V_S = \pm 2.5V$

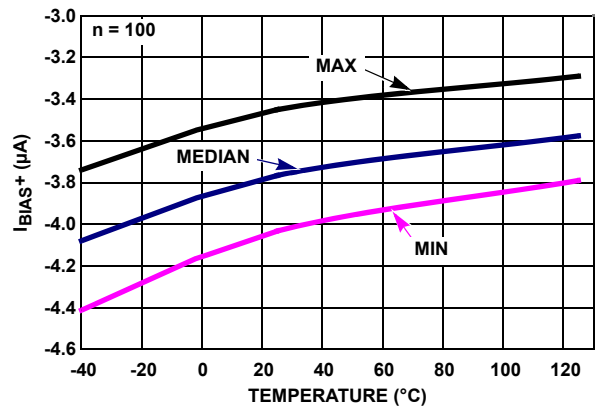

FIGURE 22.  $I_{BIAS+}$  vs TEMPERATURE,  $V_S = \pm 2.5V$

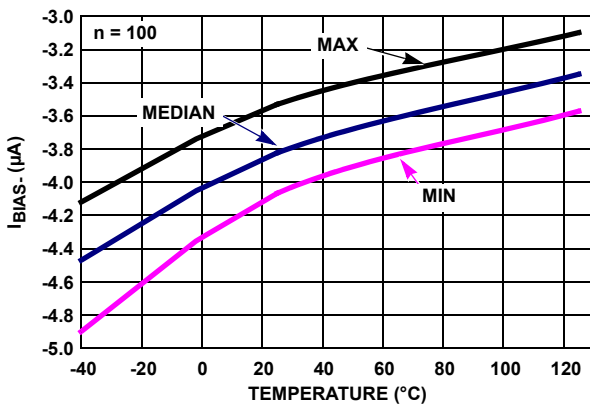

FIGURE 23.  $I_{BIAS-}$  vs TEMPERATURE,  $V_S = \pm 2.5V$

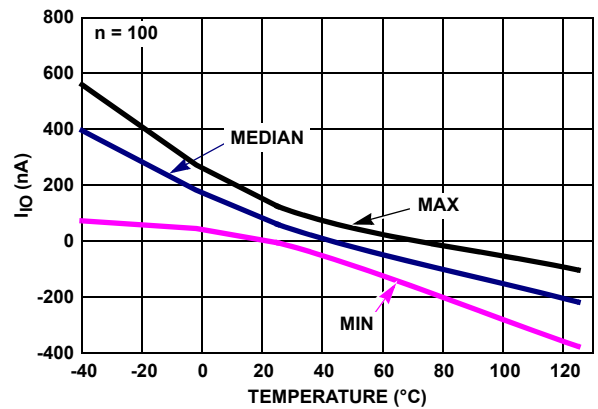

FIGURE 24.  $I_{IO}$  vs TEMPERATURE,  $V_S = \pm 2.5V$

## Typical Performance Curves (Continued)

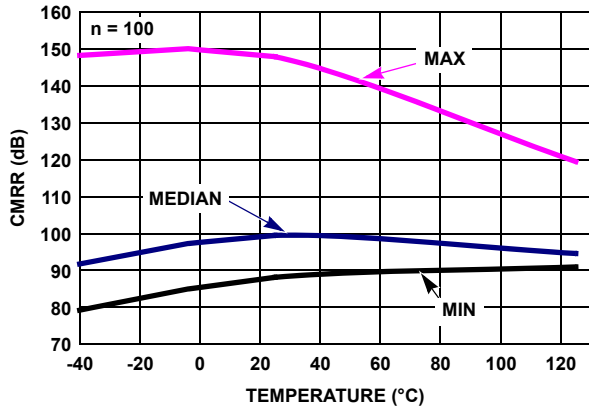

FIGURE 25. CMRR vs TEMPERATURE,  $V_{CM} = 3.8V$ ,  $V_S = \pm 2.5V$

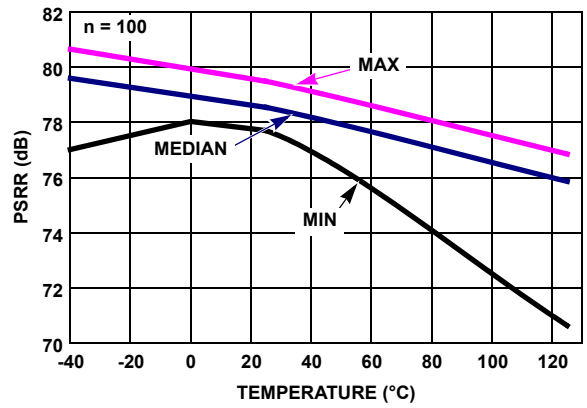

FIGURE 26. PSRR vs TEMPERATURE  $\pm 1.5V$  TO  $\pm 2.5V$

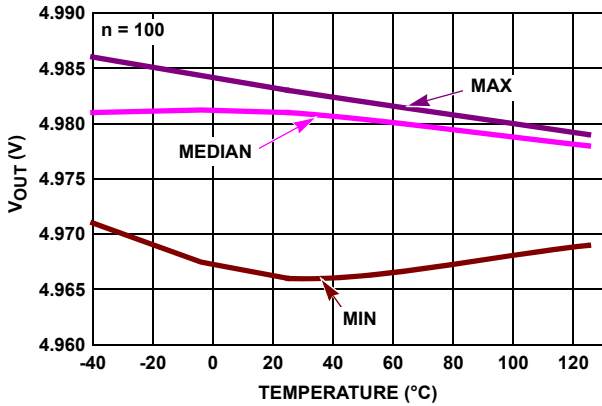

FIGURE 27. POSITIVE  $V_{OUT}$  vs TEMPERATURE,  $R_L = 1k$ ,  $V_S = \pm 2.5V$

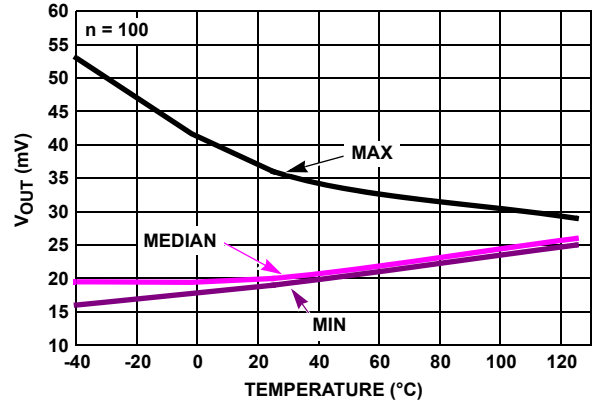

FIGURE 28. NEGATIVE  $V_{OUT}$  vs TEMPERATURE,  $R_L = 1k$ ,  $V_S = \pm 2.5V$

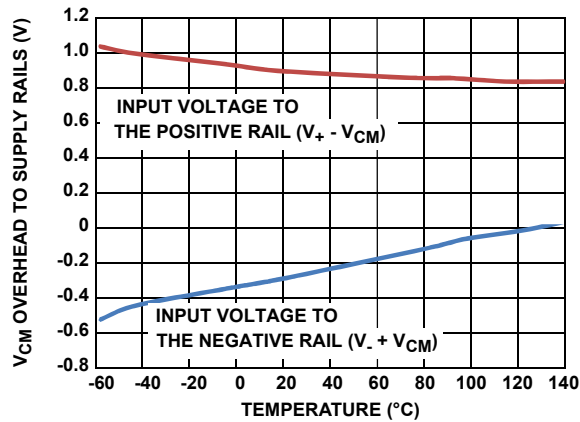

FIGURE 29. INPUT COMMON MODE VOLTAGE vs TEMPERATURE

## Applications Information

### Product Description

The ISL28191 and ISL28291 are voltage feedback operational amplifiers designed for communication and imaging applications requiring low distortion, very low voltage and current noise. Both parts feature high bandwidth while drawing moderately low supply current. They use a classical voltage-feedback topology, which allows them to be used in a variety of applications where current-feedback amplifiers are not appropriate because of restrictions placed upon the feedback element used with the amplifier.

### Enable/Power-Down

The ISL28191 and ISL28291 amplifiers are disabled by applying a voltage greater than 2V to the  $\overline{\text{EN}}$  pin, with respect to the V- pin. In this condition, the output(s) will be in a high impedance state and the amplifier(s) current will be reduced to 13 $\mu\text{A}/\text{Amp}$ . By disabling the part, multiple parts can be connected together as a MUX. The outputs are tied together in parallel and a channel can be selected by the  $\overline{\text{EN}}$  pin. The  $\overline{\text{EN}}$  pin also has an internal pull-down. If left open, the  $\overline{\text{EN}}$  pin will pull to the negative rail and the device will be enabled by default.

### Input Protection

All input terminals have internal ESD protection diodes to both positive and negative supply rails, limiting the input voltage to within one diode beyond the supply rails. Both parts have additional back-to-back diodes across the input terminals (as shown in Figure 30). In pulse applications where the input Slew Rate exceeds the Slew Rate of the amplifier, the possibility exists for the input protection diodes to become forward biased. This can cause excessive input current and distortion at the outputs. If overdriving the inputs is necessary, the external input current must never exceed 5mA. An external series resistor may be used to limit the current, as shown in Figure 30.

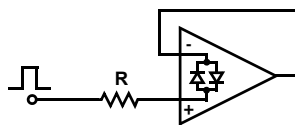

FIGURE 30. LIMITING THE INPUT CURRENT TO LESS THAN 5mA

### Using Only One Channel

The ISL28291 is a dual channel op amp. If the application only requires one channel when using the ISL28291, the user must configure the unused channel to prevent it from oscillating. Oscillation can occur if the input and output pins are floating. This will result in higher than expected supply currents and possible noise injection into the channel being used. The proper way to prevent this oscillation is to short the output to the negative input and ground the positive input (as shown in Figure 31).

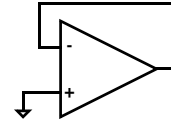

FIGURE 31. PREVENTING OSCILLATIONS IN UNUSED CHANNELS

### Power Supply Bypassing and Printed Circuit Board Layout

As with any high frequency device, good printed circuit board layout is necessary for optimum performance. Low impedance ground plane construction is essential. Surface mount components are recommended, but if leaded components are used, lead lengths should be as short as possible. The power supply pins must be well bypassed to reduce the risk of oscillation. The combination of a 4.7 $\mu\text{F}$  tantalum capacitor in parallel with a 0.01 $\mu\text{F}$  capacitor has been shown to work well when placed at each supply pin.

For good AC performance, parasitic capacitance should be kept to a minimum, especially at the inverting input. When ground plane construction is used, it should be removed from the area near the inverting input to minimize any stray capacitance at that node. Carbon or Metal-Film resistors are acceptable with the Metal-Film resistors giving slightly less peaking and bandwidth because of additional series inductance. Use of sockets, particularly for the SOIC package, should be avoided if possible. Sockets add parasitic inductance and capacitance, which will result in additional peaking and overshoot.

### Current Limiting

The ISL28191 and ISL28291 have no internal current-limiting circuitry. If the output is shorted, it is possible to exceed the Absolute Maximum Rating for output current or power dissipation, potentially resulting in the destruction of the device. This is why the output short circuit current is specified and tested with  $R_L = 10\Omega$ .

## Power Dissipation

It is possible to exceed the +125°C maximum junction temperatures under certain load and power-supply conditions. It is therefore important to calculate the maximum junction temperature ( $T_{JMAX}$ ) for all applications to determine if power supply voltages, load conditions, or package type need to be modified to remain in the safe operating area. These parameters are related in Equation 1:

$$T_{JMAX} = T_{MAX} + (\theta_{JA} \times P_{D_{MAXTOTAL}}) \quad (\text{EQ. 1})$$

where:

- $P_{D_{MAXTOTAL}}$  is the sum of the maximum power dissipation of each amplifier in the package ( $P_{D_{MAX}}$ )
- $P_{D_{MAX}}$  for each amplifier can be calculated in Equation 2:

$$P_{D_{MAX}} = 2 \times V_S \times I_{S_{MAX}} + (V_S - V_{OUTMAX}) \times \frac{V_{OUTMAX}}{R_L} \quad (\text{EQ. 2})$$

where:

- $T_{MAX}$  = Maximum ambient temperature
- $\theta_{JA}$  = Thermal resistance of the package
- $P_{D_{MAX}}$  = Maximum power dissipation of 1 amplifier
- $V_S$  = Supply voltage
- $I_{MAX}$  = Maximum supply current of 1 amplifier
- $V_{OUTMAX}$  = Maximum output voltage swing of the application
- $R_L$  = Load resistance

## Revision History

The revision history provided is for informational purposes only and is believed to be accurate, but not warranted. Please go to web to make sure you have the latest revision.

DATE	REVISION	CHANGE
July 22, 2014	FN6156.10	Updated location of note references. Updated Theta JA in the "Thermal Information" table on page 4 and added Theta JC to table.
January 18, 2012	FN6156.9	Page 1 - Ordering Information Update: Added Eval Board ISL28191EVAL1Z Changed micro TDFN and TQFN to Ultra matching POD Description Added SOT-23 Note Page 10 - Typical Performance Curves: Added Figure 29 - INPUT COMMON MODE VOLTAGE vs TEMPERATURE

## About Intersil

Intersil Corporation is a leading provider of innovative power management and precision analog solutions. The company's products address some of the largest markets within the industrial and infrastructure, mobile computing and high-end consumer markets.

For the most updated datasheet, application notes, related documentation and related parts, please see the respective product information page found at [www.intersil.com](http://www.intersil.com).

You may report errors or suggestions for improving this datasheet by visiting [www.intersil.com/ask](http://www.intersil.com/ask).

Reliability reports are also available from our website at [www.intersil.com/support](http://www.intersil.com/support)

© Copyright Intersil Americas LLC 2006-2013. All Rights Reserved.  
All trademarks and registered trademarks are the property of their respective owners.

For additional products, see [www.intersil.com/en/products.html](http://www.intersil.com/en/products.html)

Intersil products are manufactured, assembled and tested utilizing ISO9001 quality systems as noted in the quality certifications found at [www.intersil.com/en/support/qualandreliability.html](http://www.intersil.com/en/support/qualandreliability.html)

*Intersil products are sold by description only. Intersil may modify the circuit design and/or specifications of products at any time without notice, provided that such modification does not, in Intersil's sole judgment, affect the form, fit or function of the product. Accordingly, the reader is cautioned to verify that datasheets are current before placing orders. Information furnished by Intersil is believed to be accurate and reliable. However, no responsibility is assumed by Intersil or its subsidiaries for its use; nor for any infringements of patents or other rights of third parties which may result from its use. No license is granted by implication or otherwise under any patent or patent rights of Intersil or its subsidiaries.*

For information regarding Intersil Corporation and its products, see [www.intersil.com](http://www.intersil.com)

# Package Outline Drawing

## P6.064A

### 6 LEAD SMALL OUTLINE TRANSISTOR PLASTIC PACKAGE

Rev 0, 2/10

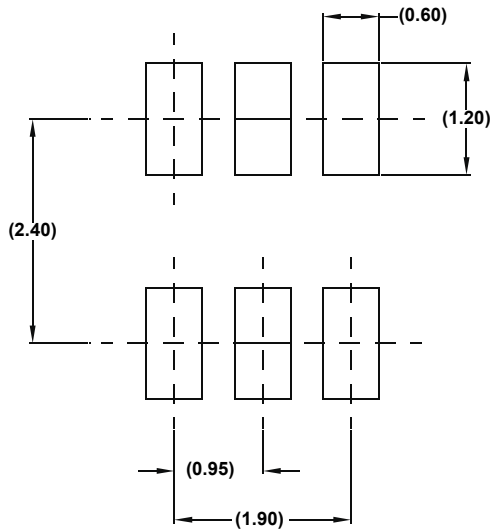
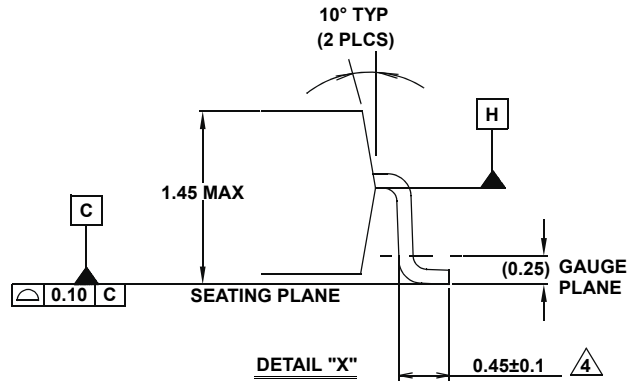
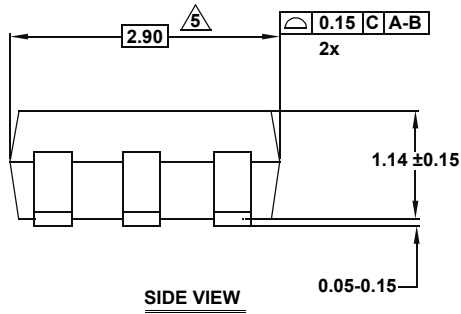
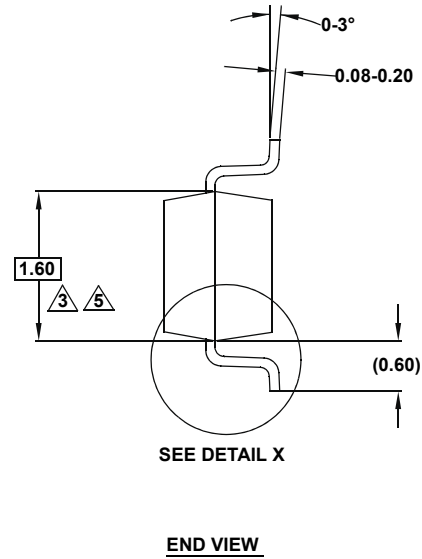
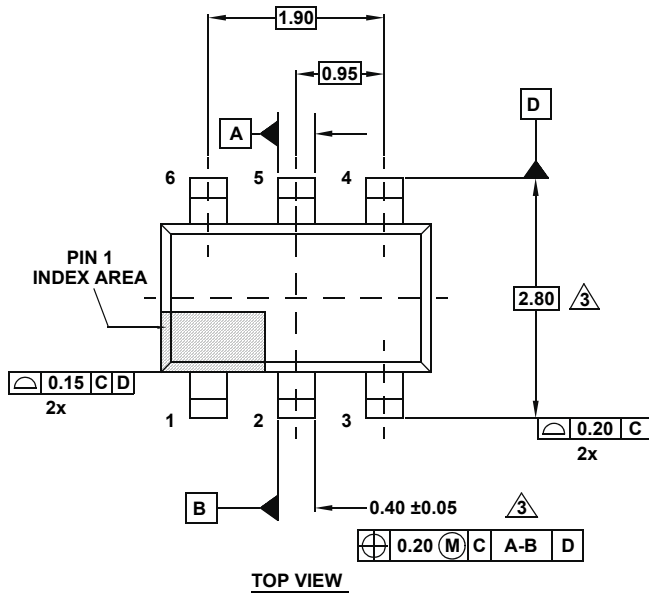

**NOTES:**

1. Dimensions are in millimeters.  
Dimensions in ( ) for Reference Only.
2. Dimensioning and tolerancing conform to ASME Y14.5M-1994.
3. Dimension is exclusive of mold flash, protrusions or gate burrs.
4. Foot length is measured at reference to gauge plane.
5. This dimension is measured at Datum "H".
6. Package conforms to JEDEC MO-178AA.

**Ultra Thin Dual Flat No-Lead Plastic Package (UTDFN)**

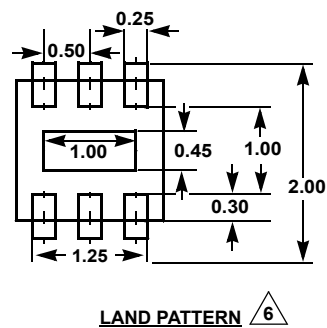
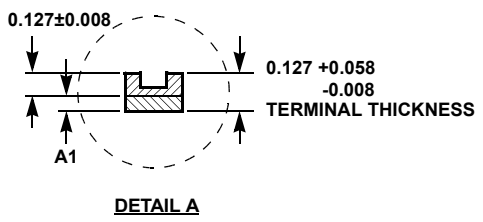
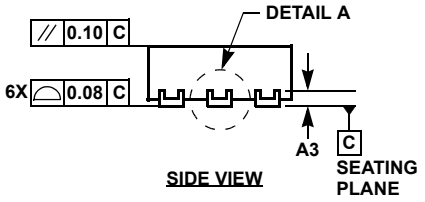
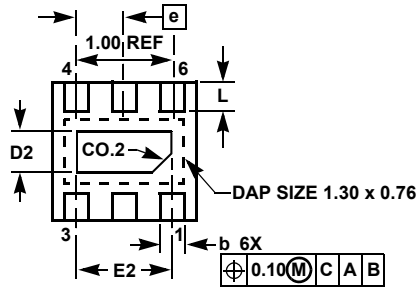
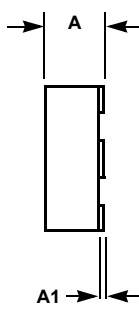
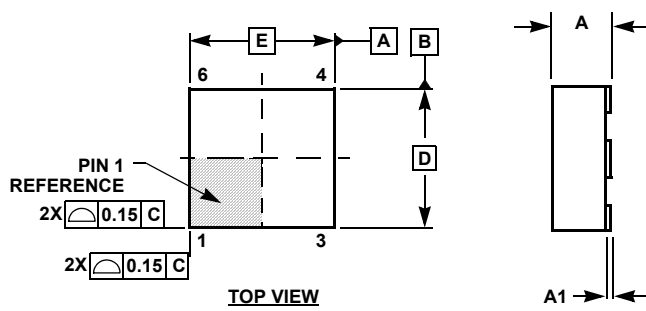

**L6.1.6x1.6A**

**6 LEAD ULTRA THIN DUAL FLAT NO-LEAD PLASTIC PACKAGE**

SYMBOL	MILLIMETERS			NOTES
	MIN	NOMINAL	MAX	
A	0.45	0.50	0.55	-
A1	-	-	0.05	-
A3	0.127 REF			-
b	0.15	0.20	0.25	-
D	1.55	1.60	1.65	4
D2	0.40	0.45	0.50	-
E	1.55	1.60	1.65	4
E2	0.95	1.00	1.05	-
e	0.50 BSC			-
L	0.25	0.30	0.35	-

Rev. 1 6/06

**NOTES:**

1. Dimensions are in mm. Angles in degrees.
2. Coplanarity applies to the exposed pad as well as the terminals. Coplanarity shall not exceed 0.08mm.
3. Warpage shall not exceed 0.10mm.
4. Package length/package width are considered as special characteristics.
5. JEDEC Reference MO-229.
6. For additional information, to assist with the PCB Land Pattern Design effort, see Intersil Technical Brief TB389.

# Package Outline Drawing

## M8.15E

### 8 LEAD NARROW BODY SMALL OUTLINE PLASTIC PACKAGE

Rev 0, 08/09

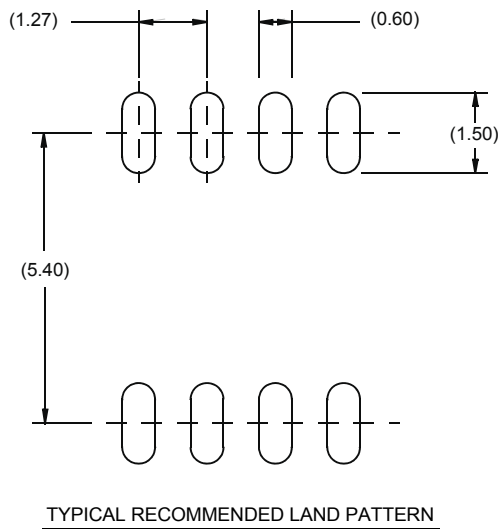
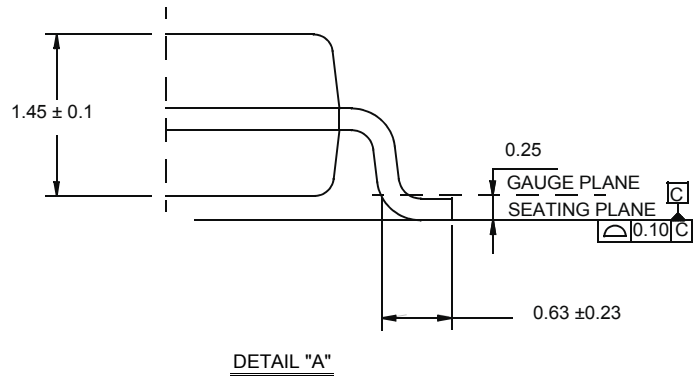
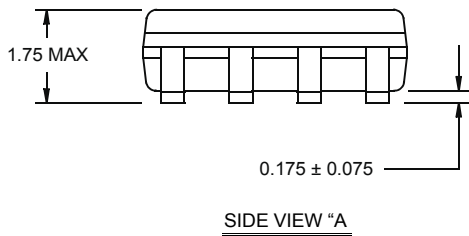
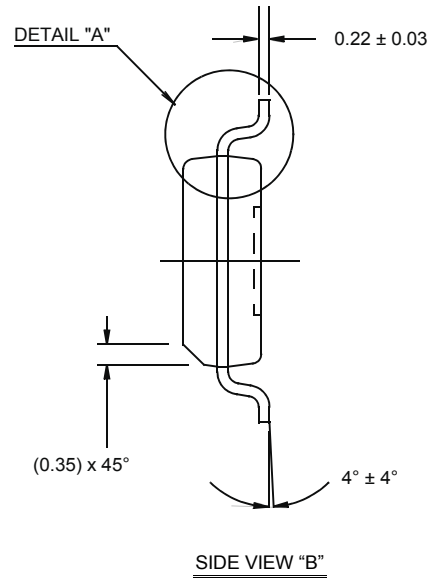
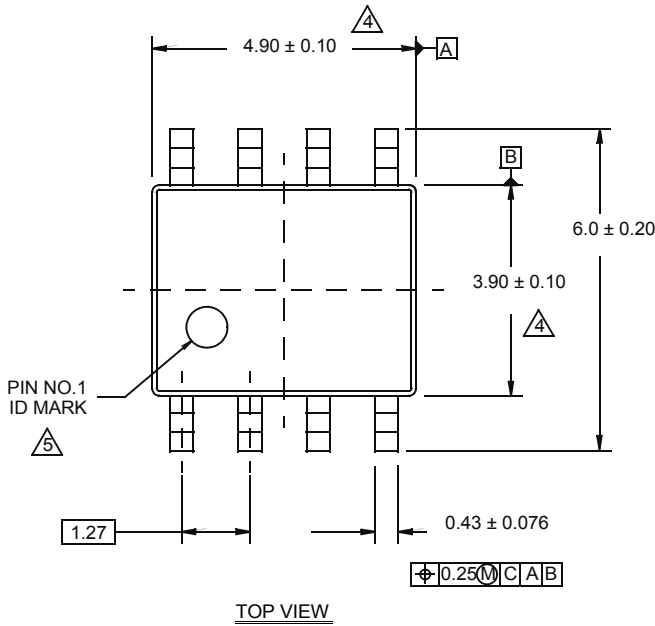

**NOTES:**

1. Dimensions are in millimeters.  
Dimensions in ( ) for Reference Only.
2. Dimensioning and tolerancing conform to AMSE Y14.5m-1994.
3. Unless otherwise specified, tolerance : Decimal ± 0.05
4. Dimension does not include interlead flash or protrusions.  
Interlead flash or protrusions shall not exceed 0.25mm per side.
5. The pin #1 identifier may be either a mold or mark feature.
6. Reference to JEDEC MS-012.



# Package Outline Drawing

## L10.1.8x1.4A

10 LEAD ULTRA THIN QUAD FLAT NO-LEAD PLASTIC PACKAGE

Rev 6, 8/13

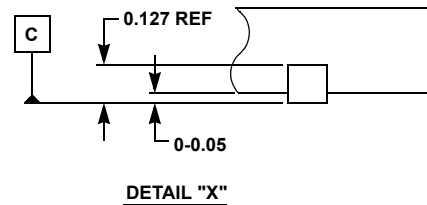
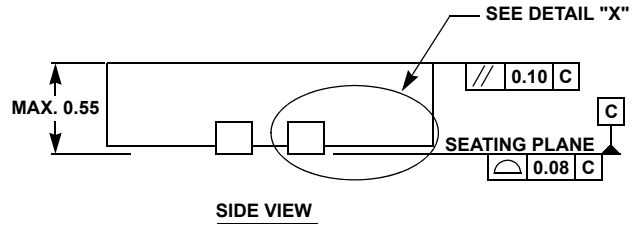
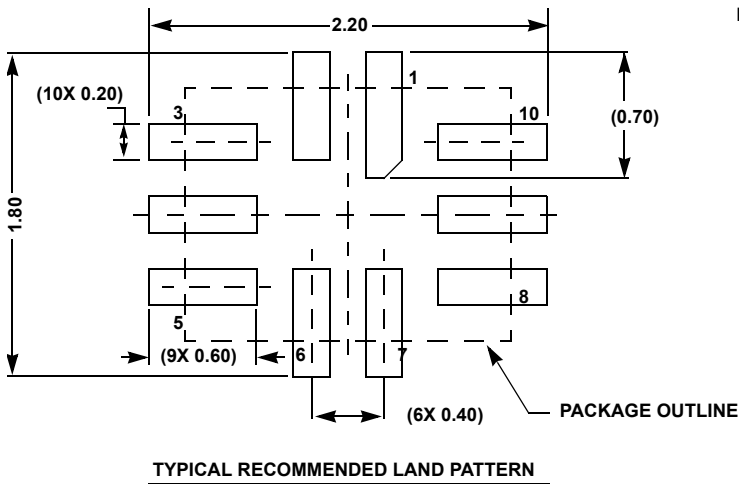
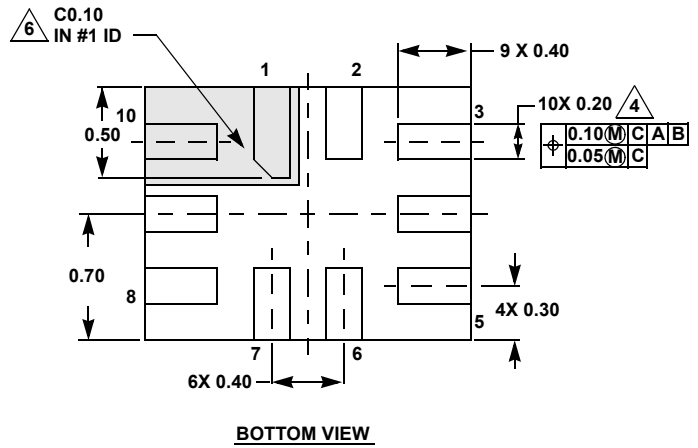
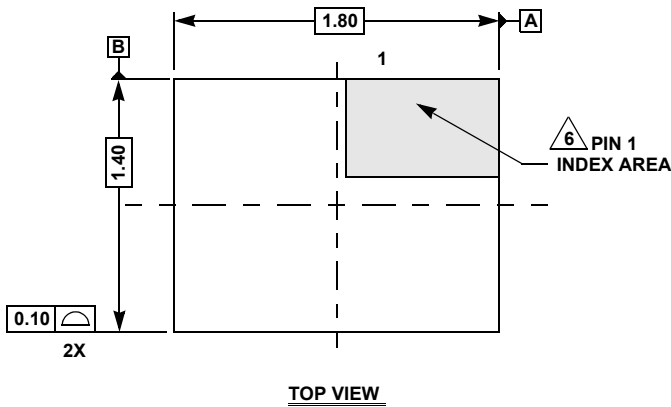

**NOTES:**

1. Dimensions are in millimeters.  
Dimensions in ( ) for Reference Only.
2. Dimensioning and tolerancing conform to ASME Y14.5m-1994.
3. Unless otherwise specified, tolerance : Decimal  $\pm 0.05$
4. Lead width dimension applies to the metallized terminal and is measured between 0.15mm and 0.30mm from the terminal tip.
5. JEDEC reference MO-255.
6. The configuration of the pin #1 identifier is optional, but must be located within the zone indicated. The pin #1 identifier may be either a mold or mark feature.

# Package Outline Drawing

**M10.118A** (JEDEC MO-187-BA)  
 10 LEAD MINI SMALL OUTLINE PLASTIC PACKAGE (MSOP)  
 Rev 0, 9/09

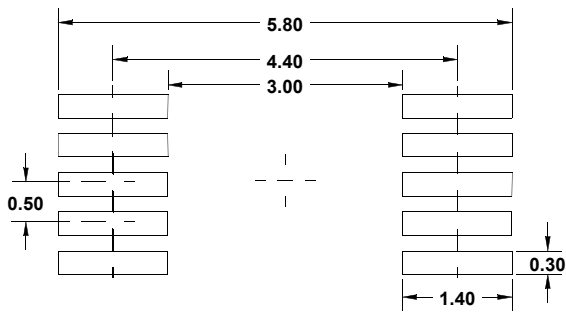
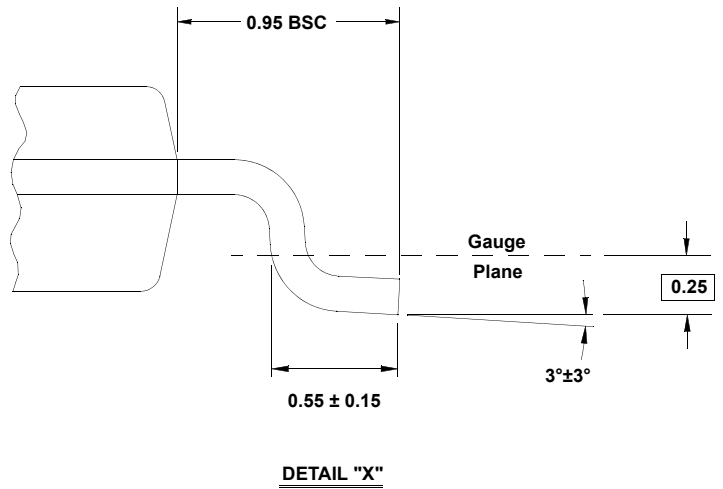
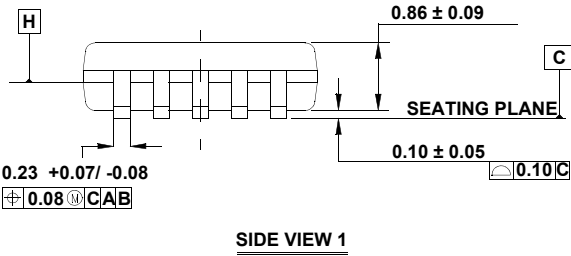
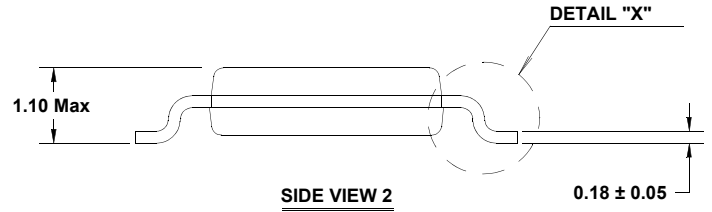
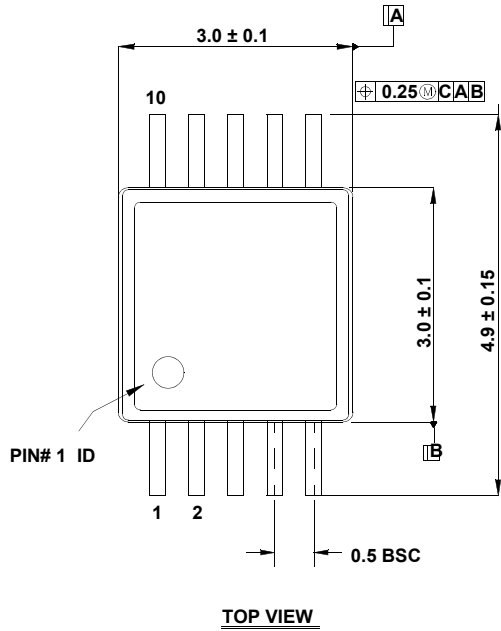

**NOTES:**

1. Dimensions are in millimeters.
2. Dimensioning and tolerancing conform to AMSE Y14.5m-1994.
3. Plastic or metal protrusions of 0.15mm max per side are not included.
4. Plastic interlead protrusions of 0.25mm max per side are not included.
5. Dimensions "D" and "E1" are measured at Datum Plane "H".
6. This replaces existing drawing # MDP0043 MSOP10L.