

NX3L2G384

Dual low-ohmic single-pole single-throw analog switch

Rev. 7 — 26 March 2013

Product data sheet

1. General description

The NX3L2G384 is a dual low-ohmic single-pole single-throw analog switch. Each switch has two input/output terminals (nY and nZ) and an active LOW enable input (n \bar{E}). When pin n \bar{E} is HIGH, the analog switch is turned off.

Schmitt trigger action at the enable input (n \bar{E}) makes the circuit tolerant to slower input rise and fall times. The NX3L2G384 allows signals with amplitude up to V_{CC} to be transmitted from nY to nZ; or from nZ to nY. Its low ON resistance (0.5 Ω) and flatness (0.13 Ω) ensures minimal attenuation and distortion of transmitted signals.

2. Features and benefits

- Wide supply voltage range from 1.4 V to 4.3 V
- Very low ON resistance (peak):
 - ◆ 1.6 Ω (typical) at $V_{CC} = 1.4$ V
 - ◆ 1.0 Ω (typical) at $V_{CC} = 1.65$ V
 - ◆ 0.55 Ω (typical) at $V_{CC} = 2.3$ V
 - ◆ 0.50 Ω (typical) at $V_{CC} = 2.7$ V
 - ◆ 0.50 Ω (typical) at $V_{CC} = 4.3$ V
- High noise immunity
- ESD protection:
 - ◆ HBM JESD22-A114F Class 3A exceeds 7500 V
 - ◆ MM JESD22-A115-A exceeds 200 V
 - ◆ CDM AEC-Q100-011 revision B exceeds 1000 V
 - ◆ IEC61000-4-2 contact discharge exceeds 4000 V for switch ports
- CMOS low-power consumption
- Latch-up performance exceeds 100 mA per JESD 78 Class II Level A
- Direct interface with TTL levels at 3.0 V
- Control input accepts voltages above the supply voltage
- High current handling capability (350 mA continuous current under 3.3 V supply)
- Specified from -40 °C to $+85$ °C and from -40 °C to $+125$ °C

3. Applications

- Cell phone
- PDA
- Portable media player



4. Ordering information

Table 1. Ordering information

Type number	Package			Version
	Temperature range	Name	Description	
NX3L2G384GT	-40 °C to +125 °C	XSON8	plastic extremely thin small outline package; no leads; 8 terminals; body 1 × 1.95 × 0.5 mm	SOT833-1
NX3L2G384GD	-40 °C to +125 °C	XSON8	plastic extremely thin small outline package; no leads; 8 terminals; body 3 × 2 × 0.5 mm	SOT996-2
NX3L2G384GM	-40 °C to +125 °C	XQFN8	plastic, extremely thin quad flat package; no leads; 8 terminals; body 1.6 × 1.6 × 0.5 mm	SOT902-2

5. Marking

Table 2. Marking codes^[1]

Type number	Marking code
NX3L2G384GT	ML2
NX3L2G384GD	ML2
NX3L2G384GM	ML2

[1] The pin 1 indicator is located on the lower left corner of the device, below the marking code.

6. Functional diagram

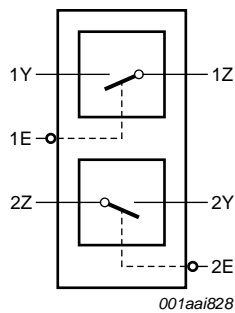

Fig 1. Logic symbol

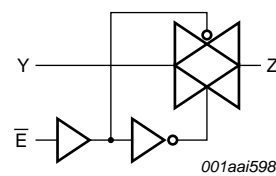
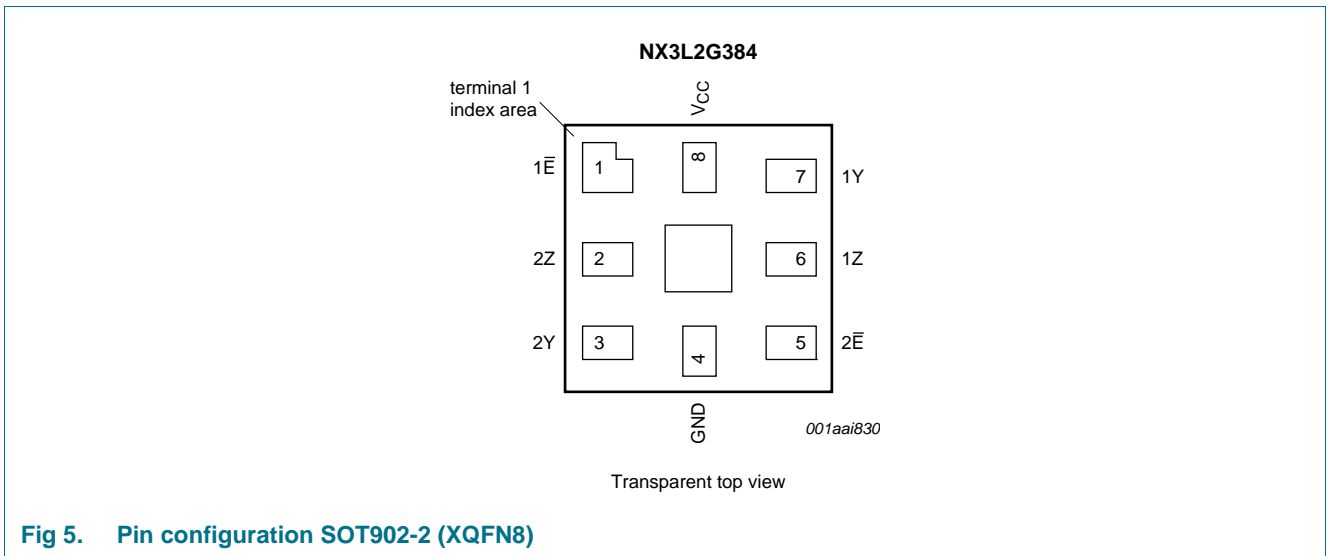
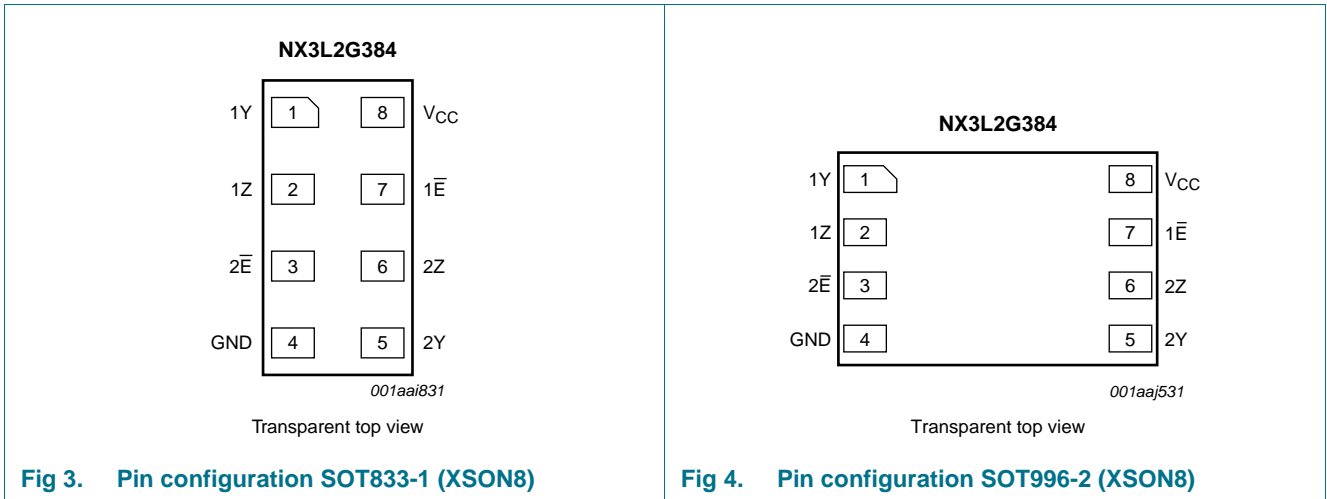

Fig 2. Logic diagram (one switch)

7. Pinning information

7.1 Pinning



7.2 Pin description

Table 3. Pin description

Symbol	Pin		Description
	SOT833-1 and SOT996-2	SOT902-2	
1Y, 2Y	1, 5	7, 3	independent input or output
1Z, 2Z	2, 6	6, 2	independent input or output
GND	4	4	ground (0 V)
1 \bar{E} , 2 \bar{E}	7, 3	1, 5	enable input (active LOW)
V _{CC}	8	8	supply voltage

8. Functional description

Table 4. Function table^[1]

Input n \bar{E}	Switch
L	ON-state
H	OFF-state

- [1] H = HIGH voltage level;
L = LOW voltage level.

9. Limiting values

Table 5. Limiting values

In accordance with the Absolute Maximum Rating System (IEC 60134). Voltages are referenced to GND (ground = 0 V).

Symbol	Parameter	Conditions	Min	Max	Unit
V _{CC}	supply voltage		-0.5	+4.6	V
V _I	input voltage	enable input n \bar{E}	^[1] -0.5	+4.6	V
V _{SW}	switch voltage		^[2] -0.5	V _{CC} + 0.5	V
I _{IK}	input clamping current	V _I < -0.5 V	-50	-	mA
I _{SK}	switch clamping current	V _I < -0.5 V or V _I > V _{CC} + 0.5 V	-	±50	mA
I _{SW}	switch current	V _{SW} > -0.5 V or V _{SW} < V _{CC} + 0.5 V; source or sink current	-	±350	mA
		V _{SW} > -0.5 V or V _{SW} < V _{CC} + 0.5 V; pulsed at 1 ms duration, < 10 % duty cycle; peak current	-	±500	mA
T _{stg}	storage temperature		-65	+150	°C
P _{tot}	total power dissipation	T _{amb} = -40 °C to +125 °C	^[3] -	250	mW

- [1] The minimum input voltage rating may be exceeded if the input current rating is observed.
 [2] The minimum and maximum switch voltage ratings may be exceeded if the switch clamping current rating is observed but may not exceed 4.6 V.
 [3] For XSON8 and XQFN8 packages: above 118 °C the value of P_{tot} derates linearly with 7.8 mW/K.

10. Recommended operating conditions

Table 6. Recommended operating conditions

Symbol	Parameter	Conditions	Min	Typ	Max	Unit
V_{CC}	supply voltage		1.4	-	4.3	V
V_I	input voltage	enable input $n\bar{E}$	0	-	4.3	V
V_{SW}	switch voltage		[1] 0	-	V_{CC}	V
T_{amb}	ambient temperature		-40	-	+125	°C
$\Delta t/\Delta V$	input transition rise and fall rate	$V_{CC} = 1.4\text{ V to }4.3\text{ V}$	[2] -	-	200	ns/V

[1] To avoid sinking GND current from terminal nZ when switch current flows in terminal nY, the voltage drop across the bidirectional switch must not exceed 0.4 V. If the switch current flows into terminal nZ, no GND current will flow from terminal nY. In this case, there is no limit for the voltage drop across the switch.

[2] Applies to control signal levels.

11. Static characteristics

Table 7. Static characteristics

At recommended operating conditions; voltages are referenced to GND (ground 0 V).

Symbol	Parameter	Conditions	$T_{amb} = 25\text{ °C}$			$T_{amb} = -40\text{ °C to }+125\text{ °C}$			Unit
			Min	Typ	Max	Min	Max (85 °C)	Max (125 °C)	
V_{IH}	HIGH-level input voltage	$V_{CC} = 1.4\text{ V to }1.95\text{ V}$	$0.65V_{CC}$	-	-	$0.65V_{CC}$	-	-	V
		$V_{CC} = 2.3\text{ V to }2.7\text{ V}$	1.7	-	-	1.7	-	-	V
		$V_{CC} = 2.7\text{ V to }3.6\text{ V}$	2.0	-	-	2.0	-	-	V
		$V_{CC} = 3.6\text{ V to }4.3\text{ V}$	$0.7V_{CC}$	-	-	$0.7V_{CC}$	-	-	V
V_{IL}	LOW-level input voltage	$V_{CC} = 1.4\text{ V to }1.95\text{ V}$	-	-	$0.35V_{CC}$	-	$0.35V_{CC}$	$0.35V_{CC}$	V
		$V_{CC} = 2.3\text{ V to }2.7\text{ V}$	-	-	0.7	-	0.7	0.7	V
		$V_{CC} = 2.7\text{ V to }3.6\text{ V}$	-	-	0.8	-	0.8	0.8	V
		$V_{CC} = 3.6\text{ V to }4.3\text{ V}$	-	-	$0.3V_{CC}$	-	$0.3V_{CC}$	$0.3V_{CC}$	V
I_I	input leakage current	enable input $n\bar{E}$; $V_I = \text{GND to }4.3\text{ V}$; $V_{CC} = 1.4\text{ V to }4.3\text{ V}$	-	-	-	-	± 0.5	± 1	μA
$I_{S(OFF)}$	OFF-state leakage current	nY port; see Figure 6							
		$V_{CC} = 1.4\text{ V to }3.6\text{ V}$	-	-	± 5	-	± 50	± 500	nA
		$V_{CC} = 3.6\text{ V to }4.3\text{ V}$	-	-	± 10	-	± 50	± 500	nA
$I_{S(ON)}$	ON-state leakage current	nZ port; see Figure 7							
		$V_{CC} = 1.4\text{ V to }3.6\text{ V}$	-	-	± 5	-	± 50	± 500	nA
		$V_{CC} = 3.6\text{ V to }4.3\text{ V}$	-	-	± 10	-	± 50	± 500	nA
I_{CC}	supply current	$V_I = V_{CC}$ or GND; $V_{SW} = \text{GND or }V_{CC}$							
		$V_{CC} = 3.6\text{ V}$	-	-	100	-	690	6000	nA
		$V_{CC} = 4.3\text{ V}$	-	-	150	-	800	7000	nA

Table 7. Static characteristics ...continued

At recommended operating conditions; voltages are referenced to GND (ground 0 V).

Symbol	Parameter	Conditions	T _{amb} = 25 °C			T _{amb} = -40 °C to +125 °C			Unit
			Min	Typ	Max	Min	Max (85 °C)	Max (125 °C)	
C _I	input capacitance		-	1.0	-	-	-	-	pF
C _{S(OFF)}	OFF-state capacitance		-	35	-	-	-	-	pF
C _{S(ON)}	ON-state capacitance		-	110	-	-	-	-	pF

11.1 Test circuits

001aaJ519

$V_I = 0.3\text{ V or }V_{CC} - 0.3\text{ V}; V_O = V_{CC} - 0.3\text{ V or }0.3\text{ V}.$

Fig 6. Test circuit for measuring OFF-state leakage current

001aaJ520

$V_I = 0.3\text{ V or }V_{CC} - 0.3\text{ V}; V_O = \text{open circuit}.$

Fig 7. Test circuit for measuring ON-state leakage current

11.2 ON resistance

Table 8. ON resistance

At recommended operating conditions; voltages are referenced to GND (ground = 0 V); for graphs see [Figure 9](#) to [Figure 15](#).

Symbol	Parameter	Conditions	T _{amb} = -40 °C to +85 °C			T _{amb} = -40 °C to +125 °C		Unit
			Min	Typ ^[1]	Max	Min	Max	
R _{ON(peak)}	ON resistance (peak)	V _I = GND to V _{CC} ; I _{SW} = 100 mA; see Figure 8						
		V _{CC} = 1.4 V	-	1.6	3.7	-	4.1	Ω
		V _{CC} = 1.65 V	-	1.0	1.6	-	1.7	Ω
		V _{CC} = 2.3 V	-	0.55	0.8	-	0.9	Ω
		V _{CC} = 2.7 V	-	0.5	0.75	-	0.9	Ω
		V _{CC} = 4.3 V	-	0.5	0.75	-	0.9	Ω

Table 8. ON resistance ...continued

At recommended operating conditions; voltages are referenced to GND (ground = 0 V); for graphs see [Figure 9](#) to [Figure 15](#).

Symbol	Parameter	Conditions	T _{amb} = -40 °C to +85 °C			T _{amb} = -40 °C to +125 °C		Unit	
			Min	Typ ^[1]	Max	Min	Max		
ΔR _{ON}	ON resistance mismatch between channels	V _I = GND to V _{CC} ; I _{SW} = 100 mA V _{CC} = 1.4 V V _{CC} = 1.65 V V _{CC} = 2.3 V V _{CC} = 2.7 V V _{CC} = 4.3 V	[2]	-	0.04	0.3	-	0.3	Ω
				-	0.04	0.2	-	0.3	Ω
				-	0.02	0.08	-	0.1	Ω
				-	0.02	0.075	-	0.1	Ω
				-	0.02	0.075	-	0.1	Ω
				-	0.02	0.075	-	0.1	Ω
R _{ON(flat)}	ON resistance (flatness)	V _I = GND to V _{CC} ; I _{SW} = 100 mA V _{CC} = 1.4 V V _{CC} = 1.65 V V _{CC} = 2.3 V V _{CC} = 2.7 V V _{CC} = 4.3 V	[3]	-	1.0	3.3	-	3.6	Ω
				-	0.5	1.2	-	1.3	Ω
				-	0.15	0.3	-	0.35	Ω
				-	0.13	0.3	-	0.35	Ω
				-	0.2	0.4	-	0.45	Ω
				-	0.2	0.4	-	0.45	Ω

[1] Typical values are measured at T_{amb} = 25 °C.

[2] Measured at identical V_{CC}, temperature and input voltage.

[3] Flatness is defined as the difference between the maximum and minimum value of ON resistance measured at identical V_{CC} and temperature.

11.3 ON resistance test circuit and graphs

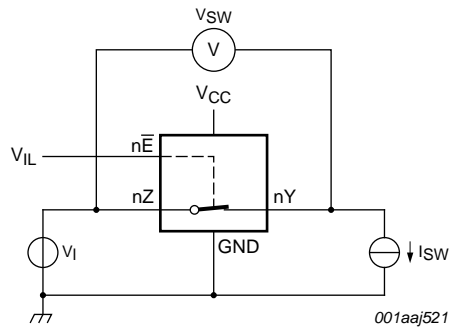

$R_{ON} = V_{SW} / I_{SW}$.

Fig 8. Test circuit for measuring ON resistance

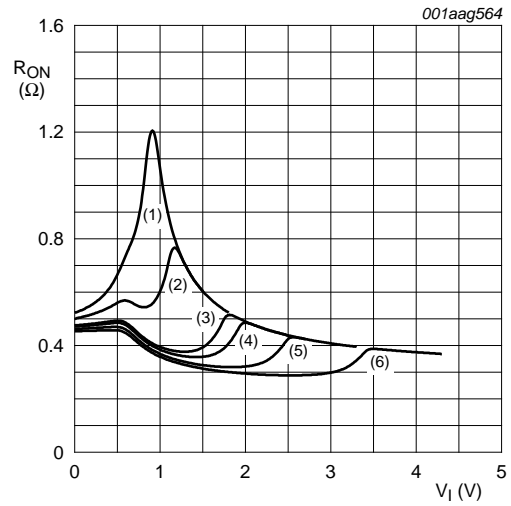

- (1) $V_{CC} = 1.5 \text{ V.}$
- (2) $V_{CC} = 1.8 \text{ V.}$
- (3) $V_{CC} = 2.5 \text{ V.}$
- (4) $V_{CC} = 2.7 \text{ V.}$
- (5) $V_{CC} = 3.3 \text{ V.}$
- (6) $V_{CC} = 4.3 \text{ V.}$

Measured at $T_{amb} = 25 \text{ }^\circ\text{C.}$

Fig 9. Typical ON resistance as a function of input voltage

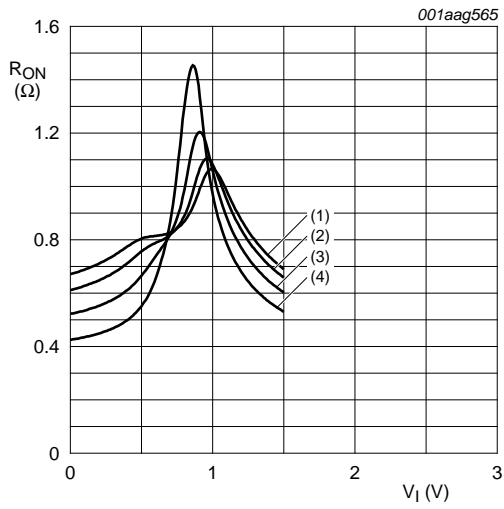

- (1) $T_{amb} = 125\text{ }^{\circ}\text{C}.$
- (2) $T_{amb} = 85\text{ }^{\circ}\text{C}.$
- (3) $T_{amb} = 25\text{ }^{\circ}\text{C}.$
- (4) $T_{amb} = -40\text{ }^{\circ}\text{C}.$

Fig 10. ON resistance as a function of input voltage;
 $V_{CC} = 1.5\text{ V}$

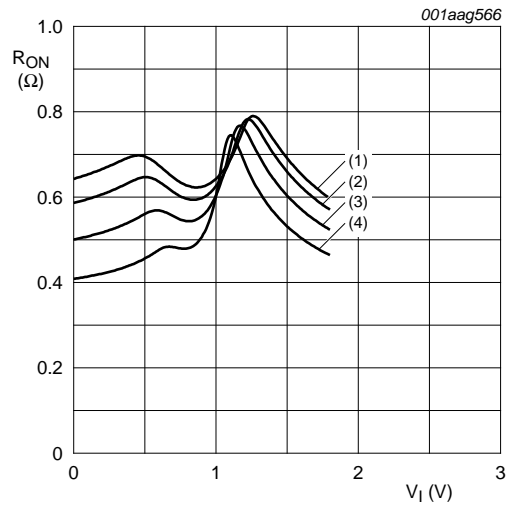

- (1) $T_{amb} = 125\text{ }^{\circ}\text{C}.$
- (2) $T_{amb} = 85\text{ }^{\circ}\text{C}.$
- (3) $T_{amb} = 25\text{ }^{\circ}\text{C}.$
- (4) $T_{amb} = -40\text{ }^{\circ}\text{C}.$

Fig 11. ON resistance as a function of input voltage;
 $V_{CC} = 1.8\text{ V}$

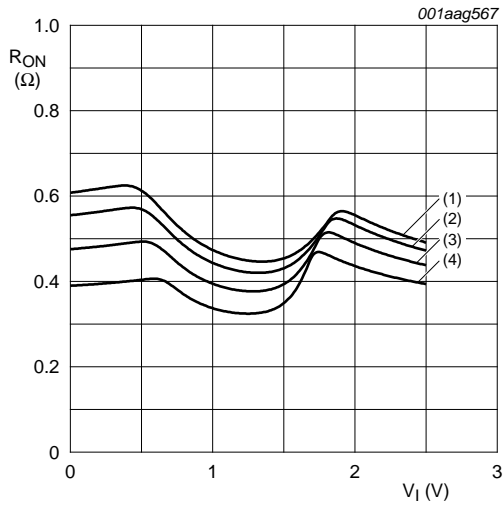

- (1) $T_{amb} = 125\text{ }^{\circ}\text{C}.$
- (2) $T_{amb} = 85\text{ }^{\circ}\text{C}.$
- (3) $T_{amb} = 25\text{ }^{\circ}\text{C}.$
- (4) $T_{amb} = -40\text{ }^{\circ}\text{C}.$

Fig 12. ON resistance as a function of input voltage;
 $V_{CC} = 2.5\text{ V}$

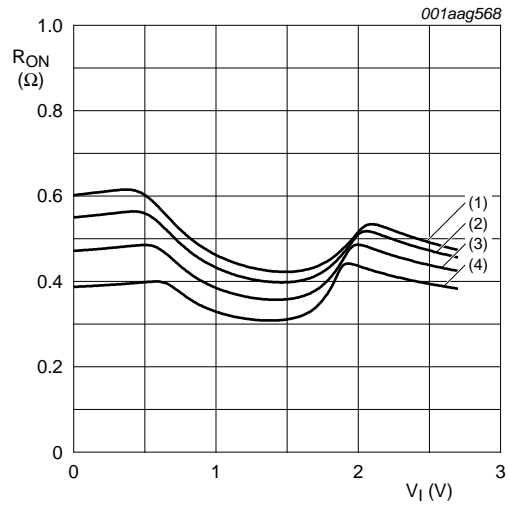

- (1) $T_{amb} = 125\text{ }^{\circ}\text{C}.$
- (2) $T_{amb} = 85\text{ }^{\circ}\text{C}.$
- (3) $T_{amb} = 25\text{ }^{\circ}\text{C}.$
- (4) $T_{amb} = -40\text{ }^{\circ}\text{C}.$

Fig 13. ON resistance as a function of input voltage;
 $V_{CC} = 2.7\text{ V}$

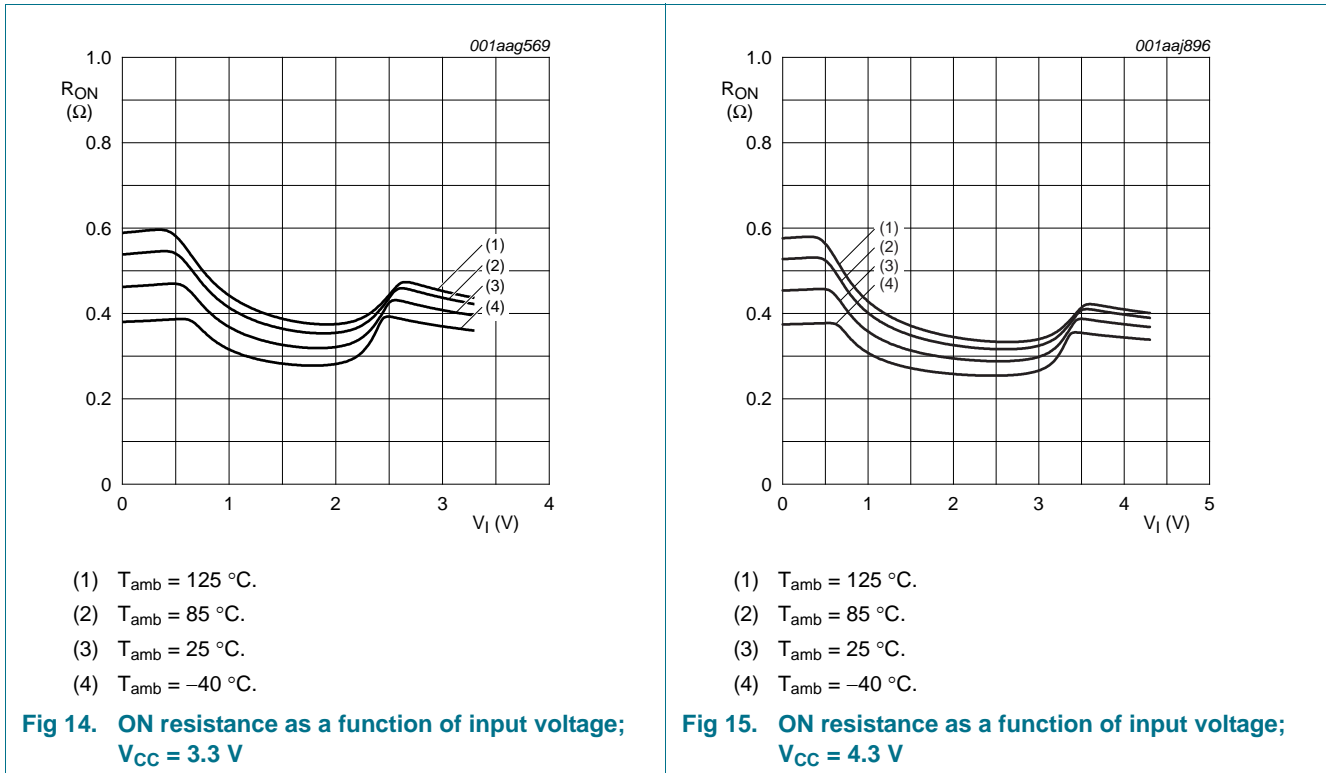

12. Dynamic characteristics

Table 9. Dynamic characteristics

At recommended operating conditions; voltages are referenced to GND (ground = 0 V); for load circuit see [Figure 17](#).

Symbol	Parameter	Conditions	T _{amb} = 25 °C			T _{amb} = -40 °C to +125 °C			Unit
			Min	Typ ^[1]	Max	Min	Max (85 °C)	Max (125 °C)	
t _{en}	enable time	n \bar{E} to nZ or nY; see Figure 16							
		V _{CC} = 1.4 V to 1.6 V	-	27	41	-	44	48	ns
		V _{CC} = 1.65 V to 1.95 V	-	23	35	-	37	40	ns
		V _{CC} = 2.3 V to 2.7 V	-	17	26	-	28	31	ns
		V _{CC} = 2.7 V to 3.6 V	-	14	24	-	25	27	ns
		V _{CC} = 3.6 V to 4.3 V	-	14	24	-	25	27	ns
t _{dis}	disable time	n \bar{E} to nZ or nY; see Figure 16							
		V _{CC} = 1.4 V to 1.6 V	-	9	17	-	19	21	ns
		V _{CC} = 1.65 V to 1.95 V	-	7	13	-	14	15	ns
		V _{CC} = 2.3 V to 2.7 V	-	4	8	-	9	10	ns
		V _{CC} = 2.7 V to 3.6 V	-	3	7	-	8	9	ns
		V _{CC} = 3.6 V to 4.3 V	-	3	7	-	8	9	ns

[1] Typical values are measured at T_{amb} = 25 °C and V_{CC} = 1.5 V, 1.8 V, 2.5 V, 3.3 V and 4.3 V respectively.

12.1 Waveform and test circuits

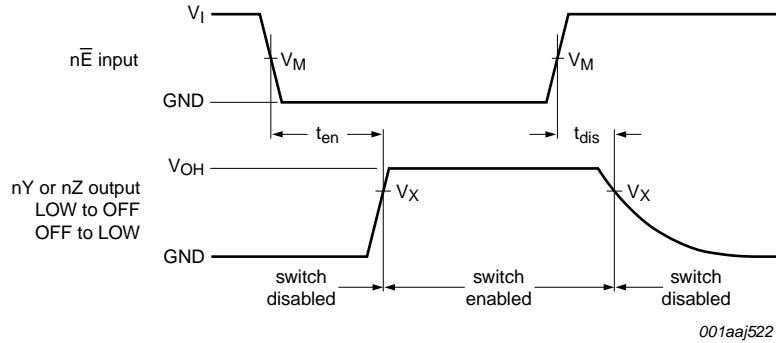

Measurement points are given in [Table 10](#).
 Logic level: V_{OH} is the typical output voltage that occurs with the output load.

Fig 16. Enable and disable times

Table 10. Measurement points

Supply voltage	Input	Output
V_{CC}	V_M	V_X
1.4 V to 4.3 V	$0.5V_{CC}$	$0.9V_{OH}$

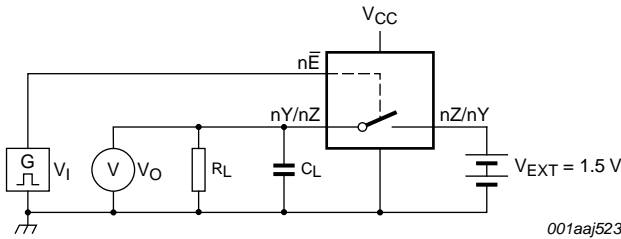

Test data is given in [Table 11](#).
 Definitions test circuit:
 R_L = Load resistance.
 C_L = Load capacitance including jig and probe capacitance.
 V_{EXT} = External voltage for measuring switching times.

Fig 17. Test circuit for measuring switching times

Table 11. Test data

Supply voltage	Input		Load	
V_{CC}	V_I	t_r, t_f	C_L	R_L
1.4 V to 4.3 V	V_{CC}	$\leq 2.5 \text{ ns}$	35 pF	50 Ω

12.2 Additional dynamic characteristics

Table 12. Additional dynamic characteristics

At recommended operating conditions; voltages are referenced to GND (ground = 0 V); $V_I = GND$ or V_{CC} (unless otherwise specified); $t_r = t_f \leq 2.5$ ns.

Symbol	Parameter	Conditions	T _{amb} = 25 °C			Unit
			Min	Typ	Max	
THD	total harmonic distortion	$f_i = 20$ Hz to 20 kHz; $R_L = 32 \Omega$; see Figure 18 [1]				
		$V_{CC} = 1.4$ V; $V_I = 1$ V (p-p)	-	0.15	-	%
		$V_{CC} = 1.65$ V; $V_I = 1.2$ V (p-p)	-	0.10	-	%
		$V_{CC} = 2.3$ V; $V_I = 1.5$ V (p-p)	-	0.02	-	%
		$V_{CC} = 2.7$ V; $V_I = 2$ V (p-p)	-	0.02	-	%
		$V_{CC} = 4.3$ V; $V_I = 2$ V (p-p)	-	0.02	-	%
$f_{(-3dB)}$	-3 dB frequency response	$R_L = 50 \Omega$; see Figure 19 [1]				
		$V_{CC} = 1.4$ V to 4.3 V	-	60	-	MHz
α_{iso}	isolation (OFF-state)	$f_i = 100$ kHz; $R_L = 50 \Omega$; see Figure 20 [1]				
		$V_{CC} = 1.4$ V to 4.3 V	-	-90	-	dB
V_{ct}	crosstalk voltage	between digital inputs and switch; $f_i = 1$ MHz; $C_L = 50$ pF; $R_L = 50 \Omega$; see Figure 21				
		$V_{CC} = 1.4$ V to 3.6 V	-	0.2	-	V
		$V_{CC} = 3.6$ V to 4.3 V	-	0.2	-	V
Xtalk	crosstalk	between switches; [1]				
		$f_i = 100$ kHz; $R_L = 50 \Omega$; see Figure 22				
		$V_{CC} = 1.4$ V to 4.3 V	-	-90	-	dB
Q_{inj}	charge injection	$f_i = 1$ MHz; $C_L = 0.1$ nF; $R_L = 1$ M Ω ; $V_{gen} = 0$ V; $R_{gen} = 0 \Omega$; see Figure 23				
		$V_{CC} = 1.5$ V	-	3	-	pC
		$V_{CC} = 1.8$ V	-	3	-	pC
		$V_{CC} = 2.5$ V	-	3	-	pC
		$V_{CC} = 3.3$ V	-	3	-	pC
		$V_{CC} = 4.3$ V	-	6	-	pC

[1] f_i is biased at $0.5V_{CC}$.

13. Test circuits

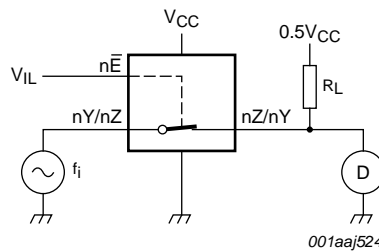
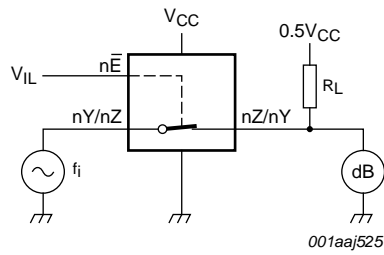
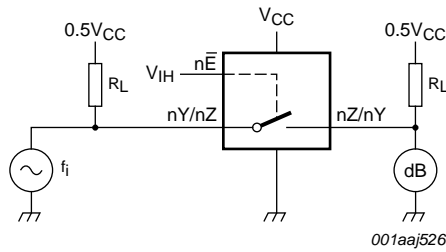

Fig 18. Test circuit for measuring total harmonic distortion



Adjust f_i voltage to obtain 0 dBm level at output. Increase f_i frequency until dB meter reads -3 dB.

Fig 19. Test circuit for measuring the frequency response when channel is in ON-state



Adjust f_i voltage to obtain 0 dBm level at input.

Fig 20. Test circuit for measuring isolation (OFF-state)

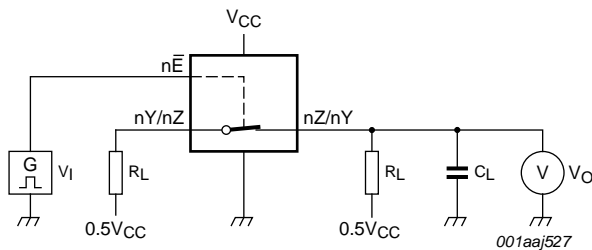

a. Test circuit

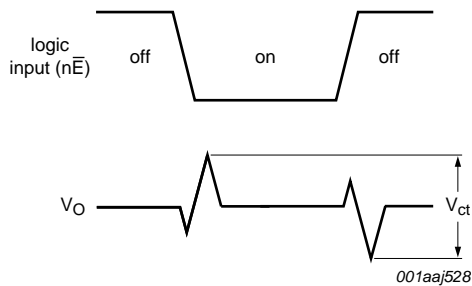

b. Input and output pulse definitions

Fig 21. Test circuit for measuring crosstalk voltage between digital inputs and switch

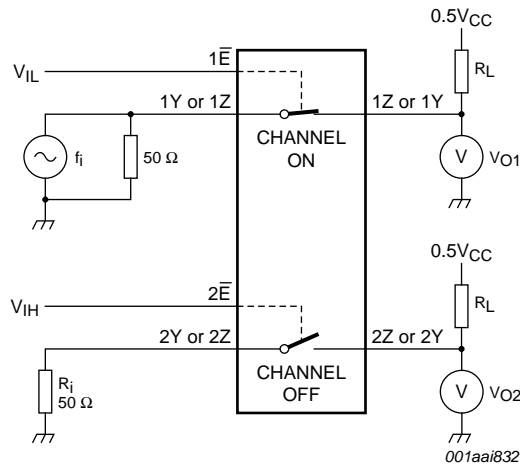

$20 \log_{10} (V_{O2} / V_{O1})$ or $20 \log_{10} (V_{O1} / V_{O2})$.

Fig 22. Test circuit for measuring crosstalk between switches

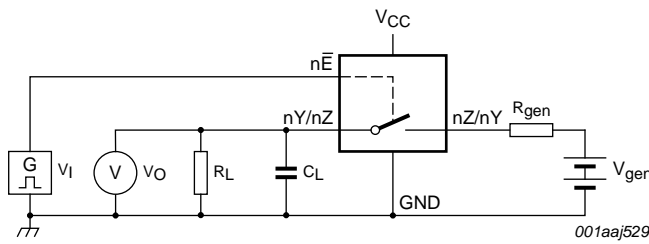

a. Test circuit

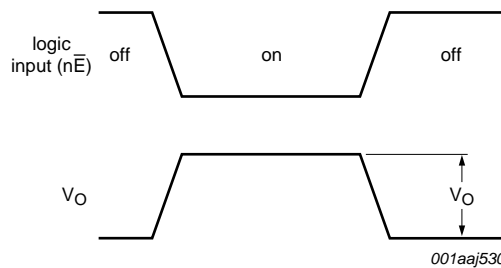

b. Input and output pulse definitions

Definition: $Q_{inj} = \Delta V_O \times C_L$.

ΔV_O = output voltage variation.

R_{gen} = generator resistance.

V_{gen} = generator voltage.

Fig 23. Test circuit for measuring charge injection

14. Package outline

XSON8: plastic extremely thin small outline package; no leads; 8 terminals; body 1 x 1.95 x 0.5 mm

SOT833-1

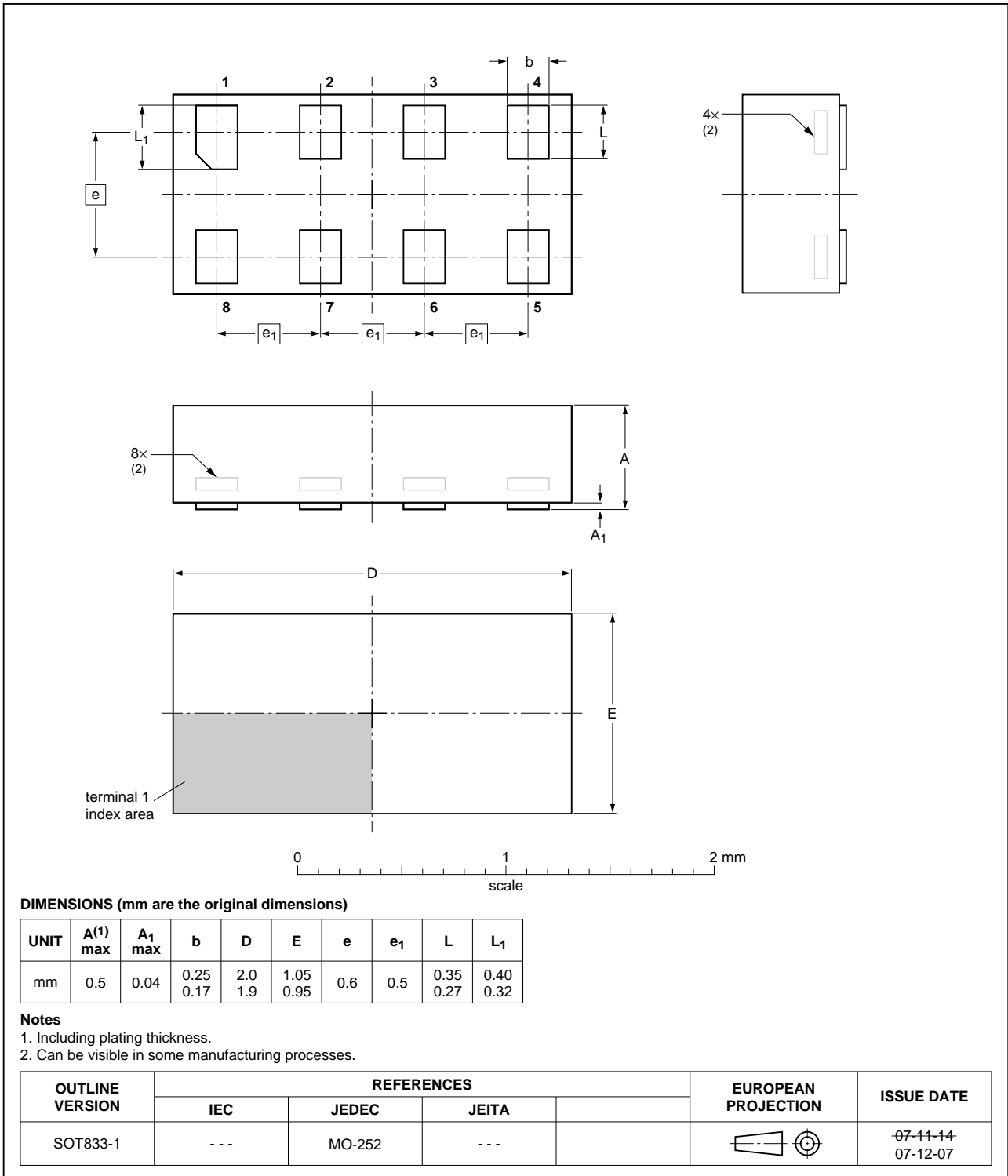

Fig 24. Package outline SOT833-1 (XSON8)

XSON8: plastic extremely thin small outline package; no leads;
8 terminals; body 3 x 2 x 0.5 mm

SOT996-2

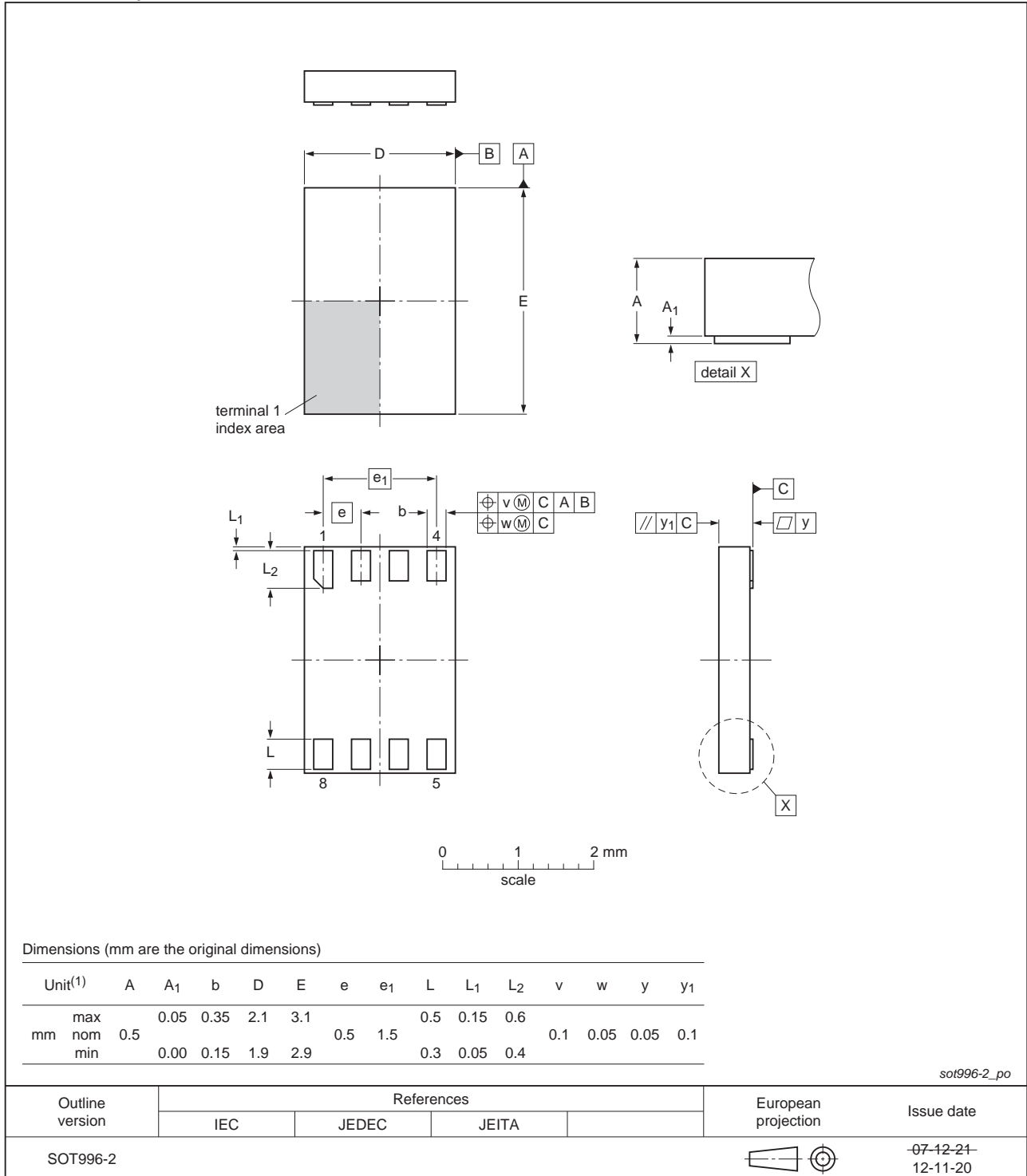

Fig 25. Package outline SOT996-2 (XSON8)

XQFN8: plastic, extremely thin quad flat package; no leads;
8 terminals; body 1.6 x 1.6 x 0.5 mm

SOT902-2

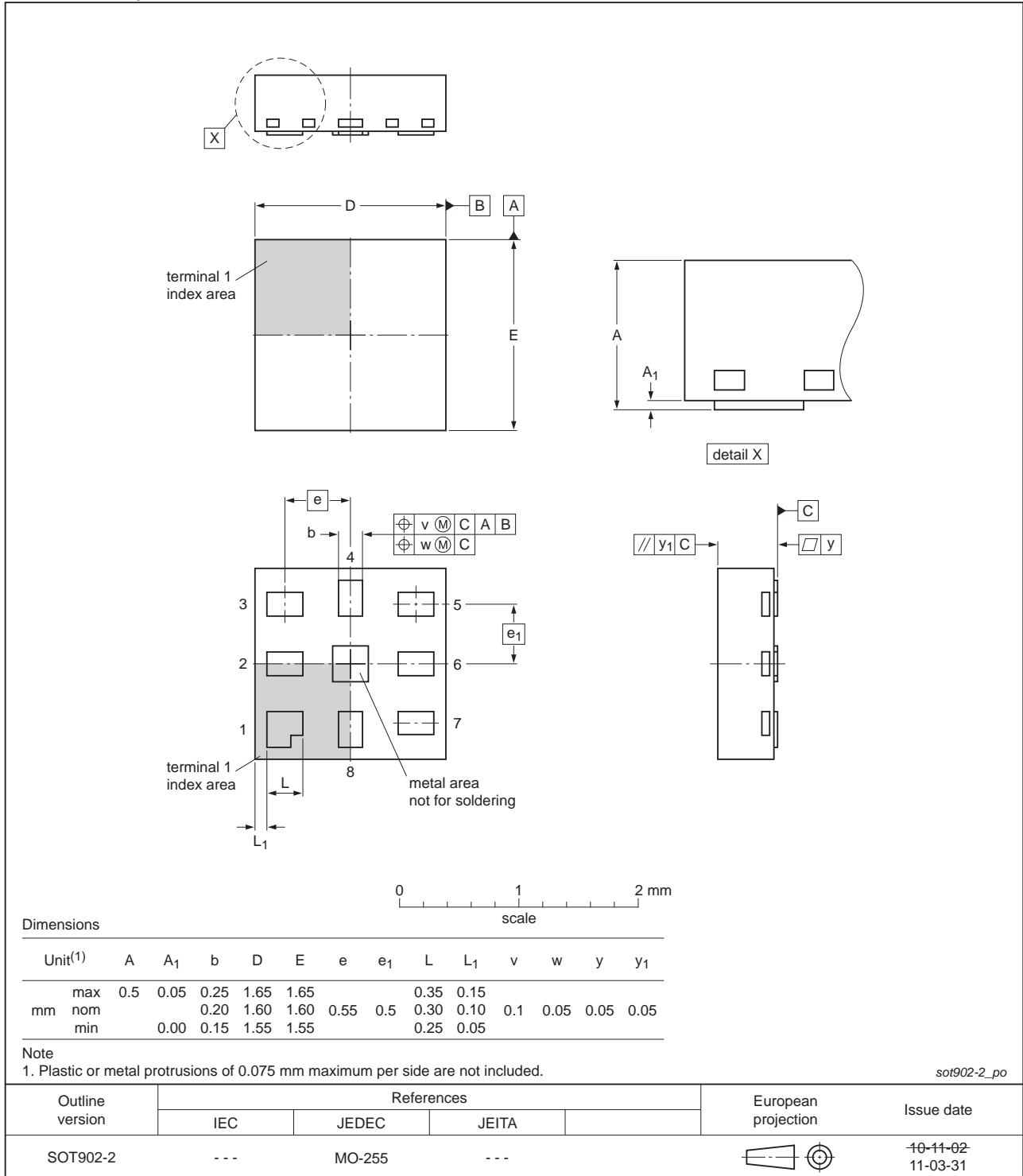

Fig 26. Package outline SOT902-2 (XQFN8)

15. Abbreviations

Table 13. Abbreviations

Acronym	Description
CDM	Charged Device Model
CMOS	Complementary Metal Oxide Semiconductor
ESD	ElectroStatic Discharge
HBM	Human Body Model
MM	Machine Model
PDA	Personal Digital Assistant
TTL	Transistor-Transistor Logic

16. Revision history

Table 14. Revision history

Document ID	Release date	Data sheet status	Change notice	Supersedes
NX3L2G384 v.7	20130326	Product data sheet	-	NX3L2G384 v.6
Modifications:	<ul style="list-style-type: none"> For type number NX3L2G384GD XSON8U has changed to XSON8. 			
NX3L2G384 v.6	20120617	Product data sheet	-	NX3L2G384 v.5
NX3L2G384 v.5	20111107	Product data sheet	-	NX3L2G384 v.4
NX3L2G384 v.4	20101228	Product data sheet	-	NX3L2G384 v.3
NX3L2G384 v.3	20090828	Product data sheet	-	NX3L2G384 v.2
NX3L2G384 v.2	20090415	Product data sheet	-	NX3L2G384 v.1
NX3L2G384 v.1	20080918	Product data sheet	-	-

17. Legal information

17.1 Data sheet status

Document status ^{[1][2]}	Product status ^[3]	Definition
Objective [short] data sheet	Development	This document contains data from the objective specification for product development.
Preliminary [short] data sheet	Qualification	This document contains data from the preliminary specification.
Product [short] data sheet	Production	This document contains the product specification.

[1] Please consult the most recently issued document before initiating or completing a design.

[2] The term 'short data sheet' is explained in section "Definitions".

[3] The product status of device(s) described in this document may have changed since this document was published and may differ in case of multiple devices. The latest product status information is available on the Internet at URL <http://www.nxp.com>.

17.2 Definitions

Draft — The document is a draft version only. The content is still under internal review and subject to formal approval, which may result in modifications or additions. NXP Semiconductors does not give any representations or warranties as to the accuracy or completeness of information included herein and shall have no liability for the consequences of use of such information.

Short data sheet — A short data sheet is an extract from a full data sheet with the same product type number(s) and title. A short data sheet is intended for quick reference only and should not be relied upon to contain detailed and full information. For detailed and full information see the relevant full data sheet, which is available on request via the local NXP Semiconductors sales office. In case of any inconsistency or conflict with the short data sheet, the full data sheet shall prevail.

Product specification — The information and data provided in a Product data sheet shall define the specification of the product as agreed between NXP Semiconductors and its customer, unless NXP Semiconductors and customer have explicitly agreed otherwise in writing. In no event however, shall an agreement be valid in which the NXP Semiconductors product is deemed to offer functions and qualities beyond those described in the Product data sheet.

17.3 Disclaimers

Limited warranty and liability — Information in this document is believed to be accurate and reliable. However, NXP Semiconductors does not give any representations or warranties, expressed or implied, as to the accuracy or completeness of such information and shall have no liability for the consequences of use of such information. NXP Semiconductors takes no responsibility for the content in this document if provided by an information source outside of NXP Semiconductors.

In no event shall NXP Semiconductors be liable for any indirect, incidental, punitive, special or consequential damages (including - without limitation - lost profits, lost savings, business interruption, costs related to the removal or replacement of any products or rework charges) whether or not such damages are based on tort (including negligence), warranty, breach of contract or any other legal theory.

Notwithstanding any damages that customer might incur for any reason whatsoever, NXP Semiconductors' aggregate and cumulative liability towards customer for the products described herein shall be limited in accordance with the *Terms and conditions of commercial sale* of NXP Semiconductors.

Right to make changes — NXP Semiconductors reserves the right to make changes to information published in this document, including without limitation specifications and product descriptions, at any time and without notice. This document supersedes and replaces all information supplied prior to the publication hereof.

Suitability for use — NXP Semiconductors products are not designed, authorized or warranted to be suitable for use in life support, life-critical or safety-critical systems or equipment, nor in applications where failure or malfunction of an NXP Semiconductors product can reasonably be expected to result in personal injury, death or severe property or environmental damage. NXP Semiconductors and its suppliers accept no liability for inclusion and/or use of NXP Semiconductors products in such equipment or applications and therefore such inclusion and/or use is at the customer's own risk.

Applications — Applications that are described herein for any of these products are for illustrative purposes only. NXP Semiconductors makes no representation or warranty that such applications will be suitable for the specified use without further testing or modification.

Customers are responsible for the design and operation of their applications and products using NXP Semiconductors products, and NXP Semiconductors accepts no liability for any assistance with applications or customer product design. It is customer's sole responsibility to determine whether the NXP Semiconductors product is suitable and fit for the customer's applications and products planned, as well as for the planned application and use of customer's third party customer(s). Customers should provide appropriate design and operating safeguards to minimize the risks associated with their applications and products.

NXP Semiconductors does not accept any liability related to any default, damage, costs or problem which is based on any weakness or default in the customer's applications or products, or the application or use by customer's third party customer(s). Customer is responsible for doing all necessary testing for the customer's applications and products using NXP Semiconductors products in order to avoid a default of the applications and the products or of the application or use by customer's third party customer(s). NXP does not accept any liability in this respect.

Limiting values — Stress above one or more limiting values (as defined in the Absolute Maximum Ratings System of IEC 60134) will cause permanent damage to the device. Limiting values are stress ratings only and (proper) operation of the device at these or any other conditions above those given in the Recommended operating conditions section (if present) or the Characteristics sections of this document is not warranted. Constant or repeated exposure to limiting values will permanently and irreversibly affect the quality and reliability of the device.

Terms and conditions of commercial sale — NXP Semiconductors products are sold subject to the general terms and conditions of commercial sale, as published at <http://www.nxp.com/profile/terms>, unless otherwise agreed in a valid written individual agreement. In case an individual agreement is concluded only the terms and conditions of the respective agreement shall apply. NXP Semiconductors hereby expressly objects to applying the customer's general terms and conditions with regard to the purchase of NXP Semiconductors products by customer.

No offer to sell or license — Nothing in this document may be interpreted or construed as an offer to sell products that is open for acceptance or the grant, conveyance or implication of any license under any copyrights, patents or other industrial or intellectual property rights.

Export control — This document as well as the item(s) described herein may be subject to export control regulations. Export might require a prior authorization from competent authorities.

Non-automotive qualified products — Unless this data sheet expressly states that this specific NXP Semiconductors product is automotive qualified, the product is not suitable for automotive use. It is neither qualified nor tested in accordance with automotive testing or application requirements. NXP Semiconductors accepts no liability for inclusion and/or use of non-automotive qualified products in automotive equipment or applications.

In the event that customer uses the product for design-in and use in automotive applications to automotive specifications and standards, customer (a) shall use the product without NXP Semiconductors' warranty of the product for such automotive applications, use and specifications, and (b) whenever customer uses the product for automotive applications beyond

NXP Semiconductors' specifications such use shall be solely at customer's own risk, and (c) customer fully indemnifies NXP Semiconductors for any liability, damages or failed product claims resulting from customer design and use of the product for automotive applications beyond NXP Semiconductors' standard warranty and NXP Semiconductors' product specifications.

Translations — A non-English (translated) version of a document is for reference only. The English version shall prevail in case of any discrepancy between the translated and English versions.

17.4 Trademarks

Notice: All referenced brands, product names, service names and trademarks are the property of their respective owners.

18. Contact information

For more information, please visit: <http://www.nxp.com>

For sales office addresses, please send an email to: salesaddresses@nxp.com

19. Contents

1 **General description** 1

2 **Features and benefits** 1

3 **Applications** 1

4 **Ordering information** 2

5 **Marking** 2

6 **Functional diagram** 2

7 **Pinning information** 3

7.1 Pinning 3

7.2 Pin description 4

8 **Functional description** 4

9 **Limiting values** 4

10 **Recommended operating conditions** 5

11 **Static characteristics** 5

11.1 Test circuits 6

11.2 ON resistance 6

11.3 ON resistance test circuit and graphs 8

12 **Dynamic characteristics** 10

12.1 Waveform and test circuits 11

12.2 Additional dynamic characteristics 12

13 **Test circuits** 12

14 **Package outline** 15

15 **Abbreviations** 18

16 **Revision history** 18

17 **Legal information** 19

17.1 Data sheet status 19

17.2 Definitions 19

17.3 Disclaimers 19

17.4 Trademarks 20

18 **Contact information** 20

19 **Contents** 21

Please be aware that important notices concerning this document and the product(s) described herein, have been included in section 'Legal information'.