



## Characteristics

Parameter	Rating	Units
Blocking Voltage	60	V <sub>P</sub>
Load Current, T <sub>A</sub> =25°C:		
With 5°C/W Heat Sink	22.8	A <sub>DC</sub>
No Heat Sink	9	
On-Resistance (max)	0.05	Ω
Thermal Impedance, Junction-to-Case, θ <sub>JC</sub>	0.3	°C/W

## Features

- 22.8A<sub>DC</sub> Load Current with 5°C/W Heat Sink
- Low 0.05Ω On-Resistance
- 60V<sub>P</sub> Blocking Voltage
- 2500V<sub>rms</sub> Input/Output Isolation
- Low Thermal Impedance: θ<sub>JC</sub> = 0.3 °C/W
- Isolated, Low Thermal Impedance Ceramic Pad for Heat Sink Applications
- Low Drive Power Requirements
- Arc-Free With No Snubbing Circuits
- No EMI/RFI Generation
- Flammability Rating UL 94 V-0

## Applications

- Industrial Controls / Motor Control
- Robotics
- Medical Equipment—Patient/Equipment Isolation
- Instrumentation
- Multiplexers
- Data Acquisition
- Electronic Switching
- I/O Subsystems
- Meters (Watt-Hour, Water, Gas)
- Transportation Equipment
- Aerospace/Defense

## Approvals

- UL 508 Certified Component: File E69938
- CSA Certified Component: Certificate 1172007

## Pin Configuration

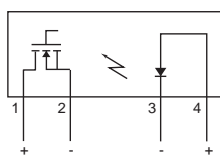

## Description

IXYS Integrated Circuits brings OptoMOS® technology, reliability and compact size to a new family of high-power Solid State Relays.

As part of this family, the CPC1709 single-pole normally open (1-Form-A) DC Solid State Power Relay employs optically coupled MOSFET technology to provide 2500V<sub>rms</sub> of input to output isolation.

The output, constructed with an efficient MOSFET switch and photovoltaic die, uses IXYS Integrated Circuits' patented OptoMOS architecture while the input, a highly efficient infrared LED, provides the optically coupled control. The combination of low on-resistance and high load current handling capability makes this relay suitable for a variety of high performance DC switching applications.

The unique ISOPLUS-264 package pioneered by IXYS enables Solid State Relays to achieve the highest load current and power ratings. This package features a unique IXYS process where the silicon chips are soft soldered onto the Direct Copper Bond (DCB) substrate instead of the traditional copper leadframe. The DCB ceramic, the same substrate used in high power modules, not only provides 2500V<sub>rms</sub> isolation but also very low junction-to-case thermal impedance (0.3 °C/W).

## Ordering Information

Part	Description
CPC1709J	ISOPLUS-264 Package (25 per tube)

## Switching Characteristics

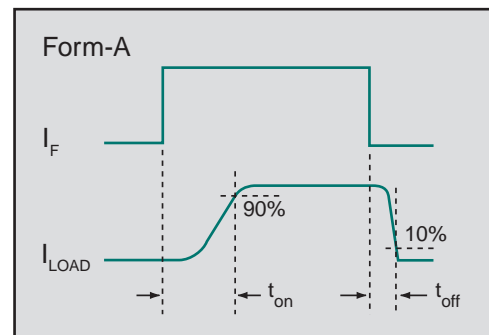

## 1 Specifications

### 1.1 Absolute Maximum Ratings @ 25°C

Symbol	Ratings	Units
Blocking Voltage	60	V <sub>P</sub>
Reverse Input Voltage	5	V
Input Control Current	100	mA
Peak (10ms)	1	A <sub>DC</sub>
Input Power Dissipation	150	mW
Isolation Voltage, Input to Output	2500	V <sub>rms</sub>
Operational Temperature	-40 to +85	°C
Storage Temperature	-40 to +125	°C

Absolute maximum ratings are stress ratings. Stresses in excess of these ratings can cause permanent damage to the device. Functional operation of the device at conditions beyond those indicated in the operational sections of this data sheet is not implied.

Typical values are characteristic of the device at +25°C, and are the result of engineering evaluations. They are provided for information purposes only, and are not part of the manufacturing testing requirements.

### 1.2 Electrical Characteristics @ 25°C

Parameter	Conditions	Symbol	Minimum	Typical	Maximum	Units
<b>Output Characteristics</b>						
Load Current <sup>1</sup>						
Peak	t ≤ 10ms	I <sub>L</sub>	-	-	40	A <sub>P</sub>
Continuous	No Heat Sink				9	A <sub>DC</sub>
Continuous	T <sub>C</sub> =25°C				32	
Continuous	T <sub>C</sub> =99°C				11	
On-Resistance <sup>2</sup>	I <sub>F</sub> =10mA, I <sub>L</sub> =1A	R <sub>ON</sub>	-	0.027	0.05	Ω
Off-State Leakage Current	V <sub>L</sub> =60V <sub>P</sub>	I <sub>LEAK</sub>	-	-	1	μA
<b>Switching Speeds</b>						
Turn-On	I <sub>F</sub> =20mA, V <sub>L</sub> =10V	t <sub>on</sub>	-	7	20	ms
Turn-Off		t <sub>off</sub>	-	0.22	5	
Output Capacitance	I <sub>F</sub> =0mA, V <sub>L</sub> =25V, f=1MHz	C <sub>out</sub>	-	4000	-	pF
<b>Input Characteristics</b>						
Input Control Current to Activate <sup>3</sup>	I <sub>L</sub> =1A	I <sub>F</sub>	-	-	10	mA
Input Dropout Current to Deactivate	-	I <sub>F</sub>	0.6	-	-	mA
Input Voltage Drop	I <sub>F</sub> =10mA	V <sub>F</sub>	0.9	1.35	1.56	V
Reverse Input Current	V <sub>R</sub> =5V	I <sub>R</sub>	-	-	10	μA
<b>Input/Output Characteristics</b>						
Capacitance, Input-to-Output	V <sub>IO</sub> =0V, f=1MHz	C <sub>IO</sub>	-	1	-	pF

<sup>1</sup> Higher load currents possible with proper heat sinking.

<sup>2</sup> Measurement taken within 1 second of on-time.

<sup>3</sup> For applications requiring high temperature operation (> 60°C) an LED drive current of 20mA is recommended.

## 2 Thermal Characteristics

Parameter	Conditions	Symbol	Rating	Units
Thermal Impedance (Junction to Case)	-	$\theta_{JC}$	0.3	$^{\circ}\text{C}/\text{W}$
Thermal Impedance (Junction to Ambient)	Free Air	$\theta_{JA}$	33	$^{\circ}\text{C}/\text{W}$
Junction Temperature (Operating)	-	$T_J$	-40 to +100	$^{\circ}\text{C}$

### 2.1 Thermal Management

Device high current characterization was performed using Kunze heat sink KU 1-159, phase change thermal interface material KU-ALC 5, and transistor clip KU 4-499/1. This combination provided an approximate junction-to-ambient thermal impedance of 12.5 $^{\circ}\text{C}/\text{W}$ .

### 2.2 Heat Sink Calculation

Higher load currents are possible by using lower thermal impedance heat sink combinations.

#### Heat Sink Rating

$$\theta_{CA} = \frac{(T_J - T_A) I_{L(99)}^2}{I_L^2 \cdot P_{D(99)}} - \theta_{JC}$$

$T_J$  = Junction Temperature ( $^{\circ}\text{C}$ ),  $T_J \leq 100^{\circ}\text{C}$  \*

$T_A$  = Ambient Temperature ( $^{\circ}\text{C}$ )

$I_{L(99)}$  = Load Current with Case Temperature @ 99 $^{\circ}\text{C}$  ( $A_{DC}$ )

$I_L$  = Desired Operating Load Current ( $A_{DC}$ ),  $I_L \leq I_{L(MAX)}$

$\theta_{JC}$  = Thermal Impedance, Junction to Case ( $^{\circ}\text{C}/\text{W}$ ) = 0.3 $^{\circ}\text{C}/\text{W}$

$\theta_{CA}$  = Thermal Impedance of Heat Sink & Thermal Interface Material, Case to Ambient ( $^{\circ}\text{C}/\text{W}$ )

$P_{D(99)}$  = Maximum power dissipation with case temperature held at 99 $^{\circ}\text{C}$  = 3.33W

\* Elevated junction temperature reduces semiconductor lifetime.

**NOTE:** The exposed surface of the DCB substrate is not to be soldered.

### 3 Performance Data\*

Unless otherwise specified, all performance data was acquired without the use of a heat sink.

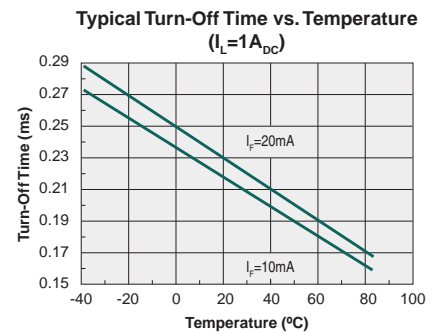
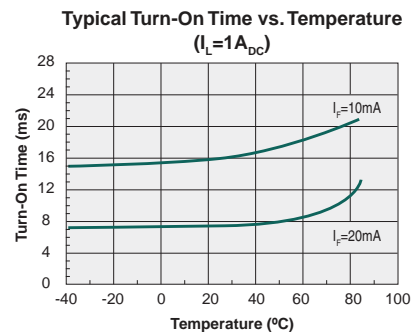
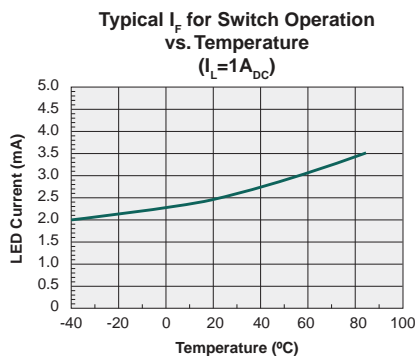
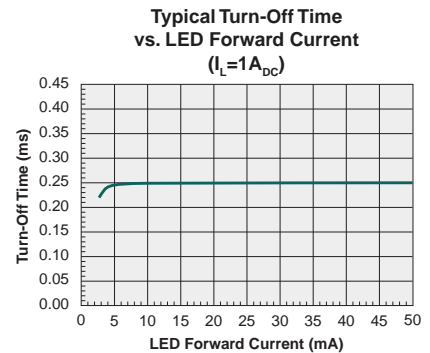
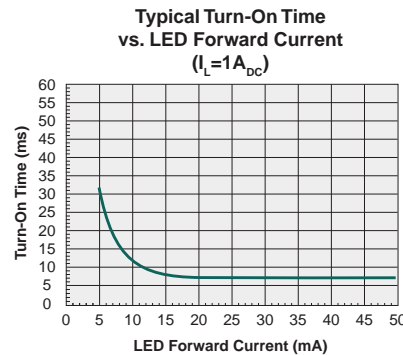
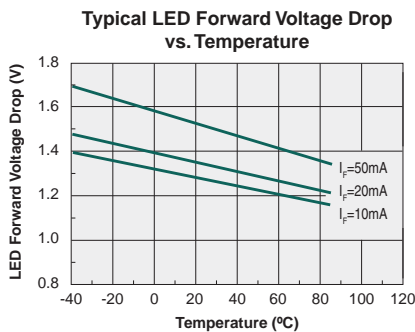
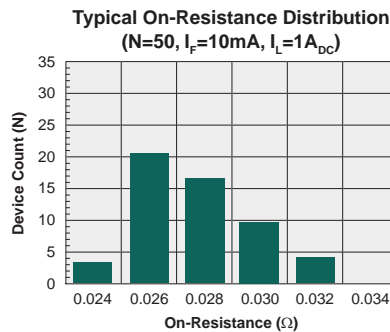
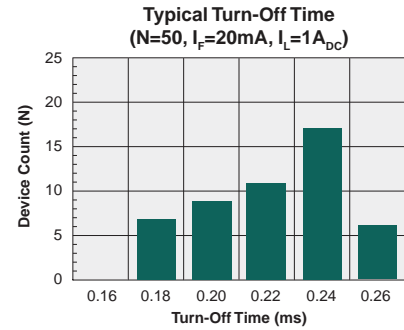
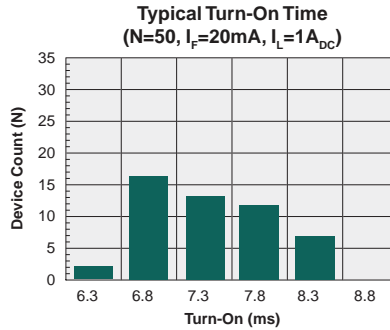
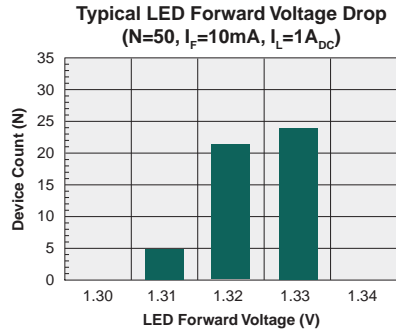

\* Unless otherwise noted, data presented in these graphs is typical of device operation at 25 $^{\circ}\text{C}$ .  
For guaranteed parameters not indicated in the written specifications, please contact our application department.

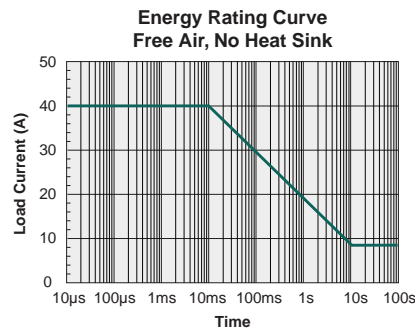
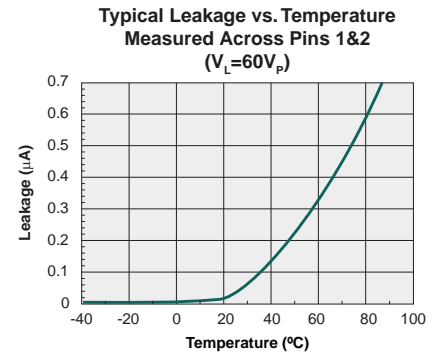
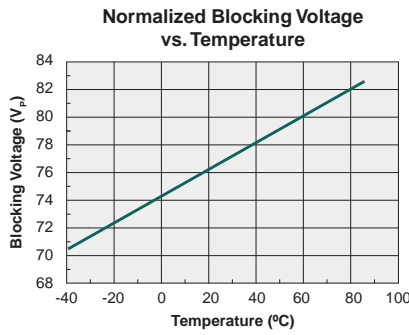
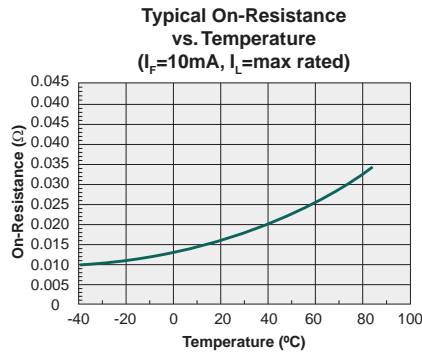
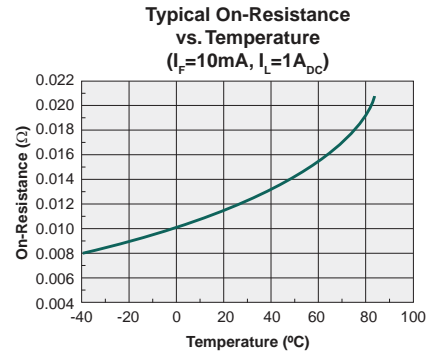
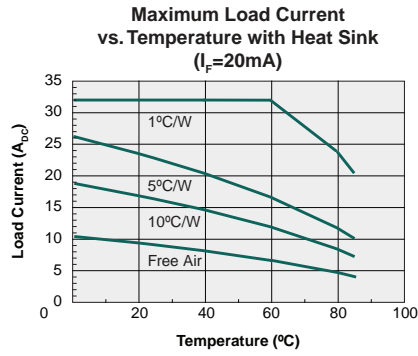
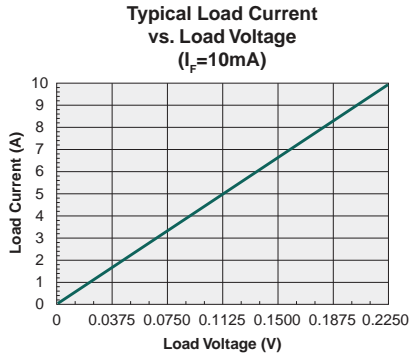

\* Unless otherwise noted, data presented in these graphs is typical of device operation at 25°C.  
For guaranteed parameters not indicated in the written specifications, please contact our application department.

## 4 Manufacturing Information

### 4.1 Moisture Sensitivity



All plastic encapsulated semiconductor packages are susceptible to moisture ingress. IXYS Integrated Circuits classifies its plastic encapsulated devices for moisture sensitivity according to the latest version of the joint industry standard, **IPC/JEDEC J-STD-020**, in force at the time of product evaluation. We test all of our products to the maximum conditions set forth in the standard, and guarantee proper operation of our devices when handled according to the limitations and information in that standard as well as to any limitations set forth in the information or standards referenced below.

Failure to adhere to the warnings or limitations as established by the listed specifications could result in reduced product performance, reduction of operable life, and/or reduction of overall reliability.

This product carries a **Moisture Sensitivity Level (MSL)** classification as shown below, and should be handled according to the requirements of the latest version of the joint industry standard **IPC/JEDEC J-STD-033**.

Device	Moisture Sensitivity Level (MSL) Classification
CPC1709J	MSL 1

### 4.2 ESD Sensitivity



This product is **ESD Sensitive**, and should be handled according to the industry standard **JESD-625**.

### 4.3 Soldering Profile

Provided in the table below is the Classification Temperature ( $T_C$ ) of this product and the maximum dwell time the body temperature of this device may be ( $T_C - 5$ )°C or greater. The classification temperature sets the Maximum Body Temperature allowed for this device during lead-free reflow processes. For through-hole devices, and any other processes, the guidelines of **J-STD-020** must be observed.

Device	Classification Temperature ( $T_C$ )	Dwell Time ( $t_p$ )	Max Reflow Cycles
CPC1709J	245°C	30 seconds	1

**NOTE:** The exposed surface of the DCB substrate is not to be soldered.

### 4.4 Board Wash

IXYS Integrated Circuits recommends the use of no-clean flux formulations. Board washing to reduce or remove flux residue following the solder reflow process is acceptable provided proper precautions are taken to prevent damage to the device. These precautions include but are not limited to: using a low pressure wash and providing a follow up bake cycle sufficient to remove any moisture trapped within the device due to the washing process. Due to the variability of the wash parameters used to clean the board, determination of the bake temperature and duration necessary to remove the moisture trapped within the package is the responsibility of the user (assembler). Cleaning or drying methods that employ ultrasonic energy may damage the device and should not be used. Additionally, the device must not be exposed to flux or solvents that are Chlorine- or Fluorine-based.



4.5 Mechanical Dimensions

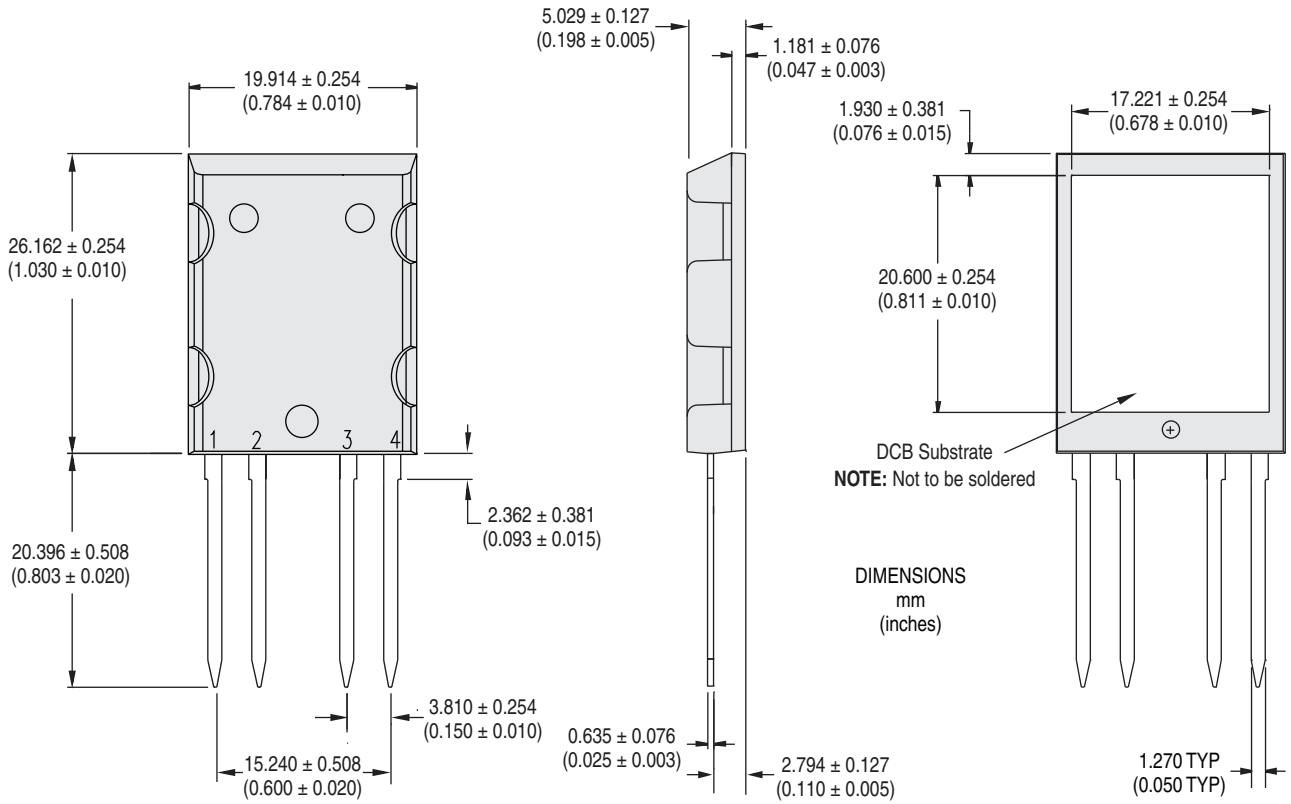

NOTE: Metallized external surface of DCB substrate maintains 2500V<sub>rms</sub> isolation to device internal structure and all external pins.

For additional information please visit our website at: [www.ixysic.com](http://www.ixysic.com)

IXYS Integrated Circuits makes no representations or warranties with respect to the accuracy or completeness of the contents of this publication and reserves the right to make changes to specifications and product descriptions at any time without notice. Neither circuit patent licenses nor indemnity are expressed or implied. Except as set forth in IXYS Integrated Circuits' Standard Terms and Conditions of Sale, IXYS Integrated Circuits assumes no liability whatsoever, and disclaims any express or implied warranty, relating to its products including, but not limited to, the implied warranty of merchantability, fitness for a particular purpose, or infringement of any intellectual property right.

The products described in this document are not designed, intended, authorized or warranted for use as components in systems intended for surgical implant into the body, or in other applications intended to support or sustain life, or where malfunction of IXYS Integrated Circuits' product may result in direct physical harm, injury, or death to a person or severe property or environmental damage. IXYS Integrated Circuits reserves the right to discontinue or make changes to its products at any time without notice.

Specification: DS-CPC1709-R09  
©Copyright 2018, IXYS Integrated Circuits  
All rights reserved. Printed in USA.  
6/18/2018