

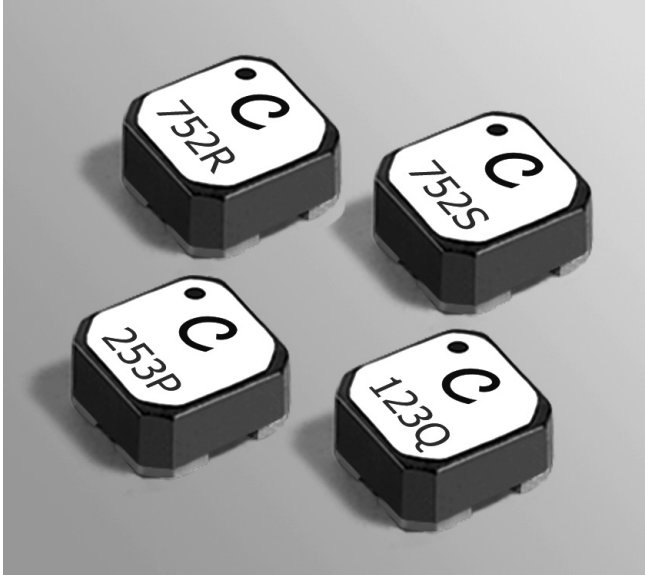

# Coupled Inductors - LPR6235

## For Step-Up, Resonant & Flyback Applications



- Can be used as step-up or flyback transformers in DC-DC converters or as autotransformers
- Perfect for low voltage step-up in energy harvesting applications
- Selected by Linear Technology for the LTC3108 and LTC3109 Ultralow Voltage Step-Up Converter and Power Managers

These shielded parts are only 3.5 mm high and 6 mm square. The excellent coupling coefficient ( $k = 0.95$ ) makes them ideal for use in a variety of applications. They can be used as flyback transformers and step-up pulse transformers.

The high  $I_{sat}$  and low DCR ratings of these parts provide high efficiency and excellent current handling in a rugged, low cost design.

Custom inductance values and turn ratios may be available upon request.

Part number <sup>1</sup>	Turns ratio	Primary (L1) inductance <sup>2</sup> ±20% (μH)	DCR max (Ohms)		SRF typ <sup>3</sup> (kHz)	Isat <sup>4</sup> (A)
			L1	L2		
LPR6235-253LML_	1: 10	25	0.74	13.7	1300	1.3
LPR6235-253PML_	1: 20	25	0.20	72	580	0.7
LPR6235-123QML_	1: 50	12.5	0.085	200	360	0.9
LPR6235-752RML_	1: 90	7.5	0.085	285	257	1.6
LPR6235-752SML_	1: 100	7.5	0.085	316	230	1.6

1. When ordering, please specify **packaging** code:

**LPR6235-253PMLC**

**Packaging:** **C** = 7" machine-ready reel. EIA-481 embossed plastic tape (350 parts per full reel).

**B** = Less than full reel. In tape, but not machine ready. To have a leader and trailer added (\$25 charge), use code letter D instead.

**D** = 13" machine-ready reel. EIA-481 embossed plastic tape. Factory order only, not stocked (1500 parts per full reel).

2. Inductance is measured at 100 kHz, 0.1 Vrms, 0 Adc on an Agilent/HP 4284A LCR meter or equivalent.

3. SRF measured using an Agilent/HP 4191A or equivalent.

4. DC current applied to L1, at which the inductance drops 10% from its value without current.

5. Electrical specifications at 25°C.

Refer to Doc 362 "Soldering Surface Mount Components" before soldering.

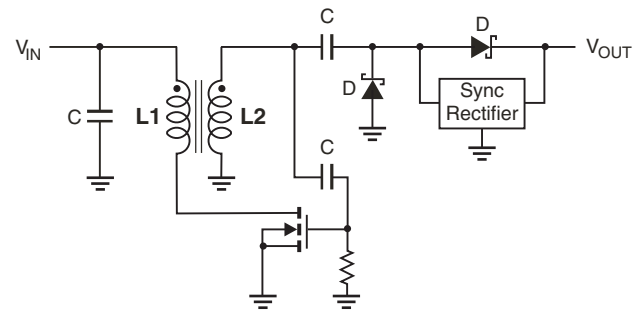

Typical Step-Up Converter

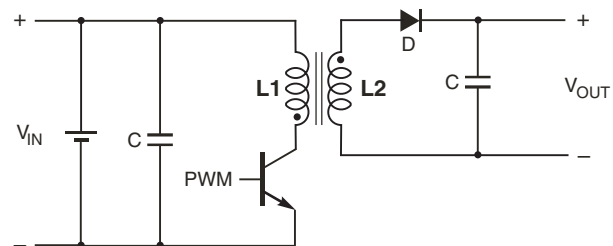

Typical Flyback Converter



www.coilcraft.com

**US** +1-847-639-6400 sales@coilcraft.com  
**UK** +44-1236-730595 sales@coilcraft-europe.com  
**Taiwan** +886-2-2264 3646 sales@coilcraft.com.tw  
**China** +86-21-6218 8074 sales@coilcraft.com.cn  
**Singapore** +65-6484 8412 sales@coilcraft.com.sg

Document 752-1 Revised 10/22/13

© Coilcraft Inc. 2013

This product may not be used in medical or high risk applications without prior Coilcraft approval. Specification subject to change without notice. Please check web site for latest information.



# Step-Up/Flyback Transformers – LPR6235

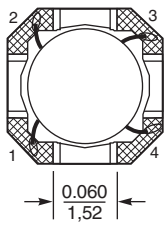
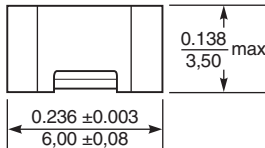
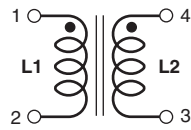
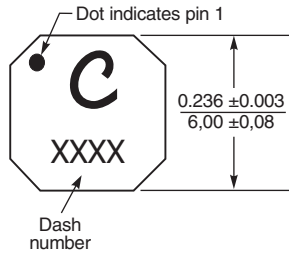

Dimensions are in  $\frac{\text{inches}}{\text{mm}}$

## Recommended Land Pattern

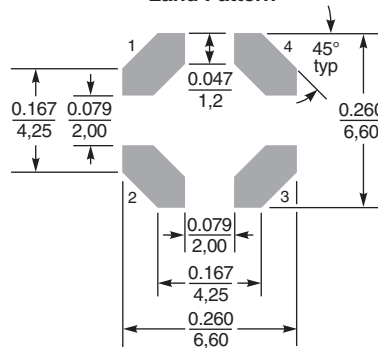

**Core material** Ferrite

**Weight** 460 – 480 mg

**Terminations** RoHS compliant silver-palladium-platinum-glass frit. Other terminations available at additional cost.

**Ambient temperature** –40°C to +85°C with Irms current, +85°C to +125°C with derated current

**Storage temperature** Component: –40°C to +125°C. Tape and reel packaging: –40°C to +80°C

**Winding to winding isolation** 300 Vrms

**Resistance to soldering heat** Max three 40 second reflows at +260°C, parts cooled to room temperature between cycles

**Moisture Sensitivity Level (MSL)** 1 (unlimited floor life at <30°C / 85% relative humidity)

**Mean Time Between Failures (MTBF)** 26,315,789 hours

**Failures in Time (FIT)** 38 per one billion hours

**Packaging** 350/7" reel; 1500/13" reel Plastic tape: 16 mm wide, 0.3 mm thick, 12 mm pocket spacing, 3.68 mm pocket depth

**Recommended pick and place nozzle** OD: 6.2 mm; ID: ≤ 3.1 mm

**PCB washing** Tested with pure water or alcohol only. For other solvents, see Doc787\_PCB\_Washing.pdf.