

4

3

2

1

THIS DRAWING IS UNPUBLISHED.

RELEASED FOR PUBLICATION

20

© COPYRIGHT 20

BY -

ALL RIGHTS RESERVED.

REVISIONS

P	LTR	DESCRIPTION	DATE	DWN	APVD
A		INITIAL RELEASE	14APR2015	GY	CW
B		ECR-15-013759	27SEP2015	DW	CW
B1		ECR-16-011988	25AUG2016	YC	CW
B2		ECR-18-017123	15DEC2018	KW	CW

PANEL CUT FOR INSERTS FOR USE  
WITHOUT HOODS/ HOUSINGS

不使用防护外壳时芯件的安装开孔图

NOTES:

1. TECHNICAL CHARACTERISTICS:  
INSULATION MATERIAL: PC  
RATED VOLTAGE: 500V  
RATED CURRENT: 16A  
INSULATION RESISTANCE:  $\geq 400M\Omega$   
RATED IMPULSE VOLTAGE: 6KV  
POLLUTION DEGREE: 3  
FLAMMABILITY: UL94V-0  
MATING CYCLES: 500 CYCLES  
WIRE RANGE:  $0.5mm^2 \sim 2.5mm^2$  (AWG20-AWG14)  
CONTACT TYPE: SCREW CLAMP (M3)

10X M3 SCREW, RECOMMENDED  
TIGHTENING TORQUE 0.5Nm  
10X M3螺丝, 推荐锁紧力矩0.5Nm

M4 SCREW, RECOMMENDED  
TIGHTENING TORQUE 1.2Nm  
M4螺丝, 推荐锁紧力矩1.2Nm

4X M3 SCREW, RECOMMENDED  
TIGHTENING TORQUE 0.5Nm  
4X M3螺丝, 推荐锁紧力矩0.5Nm

TYPE 1, T2040102201-000, WITH LOGO  
类型 1, T2040102201-000, 带LOGO

THIS DRAWING IS A CONTROLLED DOCUMENT.

DIMENSIONS:

mm

TOLERANCES UNLESS OTHERWISE SPECIFIED:

0 PLC	±-
1 PLC	±-
2 PLC	±-
3 PLC	±-
4 PLC	±-
ANGLES	±-

MATERIAL

FINISH

DWN 14APR2015

GINO YAO

CHK 14APR2015

CHRIS WANG

APVD 14APR2015

XIANG XU

PRODUCT SPEC

108-137044

APPLICATION SPEC

114-137044

WEIGHT

-

CUSTOMER DRAWING

TE Connectivity

NAME

HE-010-F

SIZE

A3

CAGE CODE

00779

DRAWING NO

G-T2040102201000

RESTRICTED TO

-

SCALE

1:1

SHEET

1 OF 2

REV

B2

1470-19 (3/13)

THIS DRAWING IS UNPUBLISHED.

RELEASED FOR PUBLICATION

20

© COPYRIGHT 20 BY -

ALL RIGHTS RESERVED.

REVISIONS

P	LTR	DESCRIPTION	DATE	DWN	APVD
-		SEE SHEET 1	-	-	-

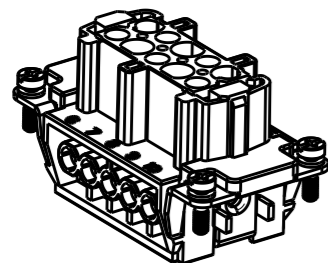

TYPE 2, T2040102201-001, WITHOUT LASER SIDE MARK  
 类型 2, T2040102201-001, 不带侧面激光标识

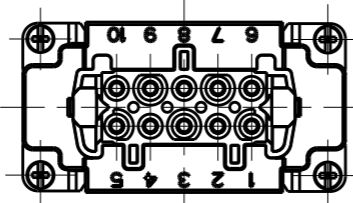
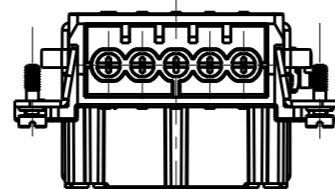
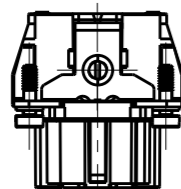
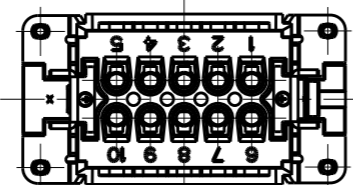

NOTE:  
 ALL SPEC REFER TO TYPE 1

注释:  
 所有产品规范参照 TYPE 1

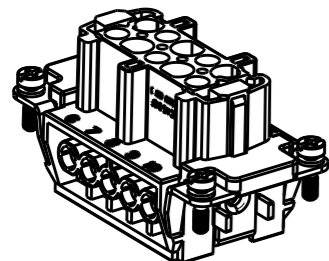

TYPE 3, T2049102201-000, WITHOUT LASER LOGO  
 类型 3, T2049102201-000, 不带激光LOGO标识

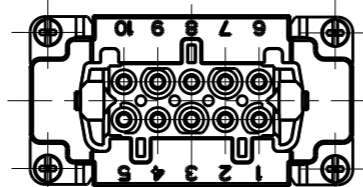
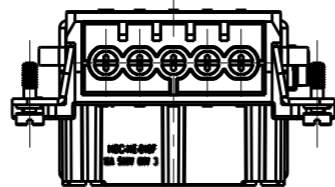
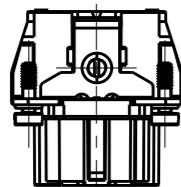
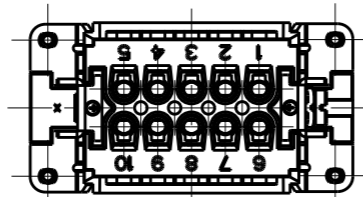

T2040102201-000	HE-010-F	HE-010 FEMALE INSERT HE-010 母插	TYPE 1
T2040102201-001	HE-010-F	HE-010 FEMALE INSERT, WITHOUT LASER SIDE MARK HE-010 母插, 无激光侧面标识	TYPE 2
T2049102201-000	HE-010-F	HE-010 FEMALE INSERT, WITHOUT LOGO HE-010 母插, 无LOGO	TYPE 3
PART NUMBER 料号	PART DESCRIPTION 描述		TYPE 类型

THIS DRAWING IS A CONTROLLED DOCUMENT.

DIMENSIONS: mm	TOLERANCES UNLESS OTHERWISE SPECIFIED:
	0 PLC ±-
	1 PLC ±-
	2 PLC ±-
	3 PLC ±-
	4 PLC ±-
	ANGLES ±-
MATERIAL	FINISH
-	-
-	-

DWN	14APR2015
GINO YAO	
CHK	14APR2015
CHRIS WANG	
APVD	14APR2015
XIANG XU	
PRODUCT SPEC	108-137044
APPLICATION SPEC	114-137044
WEIGHT	-
CUSTOMER DRAWING	

NAME HE-010-F			
SIZE	CAGE CODE	DRAWING NO	RESTRICTED TO
A3	00779	©-T2040102201000	-
SCALE		SHEET	REV
1:1		2 OF 2	B2