

# ESD131-B1-W0201

## Protection Devices

TVS (Transient Voltage Suppressor)

Bi-directional, 5.5 V, 0.23 pF, 0201, RoHS and Halogen Free compliant

## Features

- ESD / transient protection according to:
  - IEC61000-4-2 (ESD):  $\pm 20$  kV (air / contact discharge)
  - IEC61000-4-4 (EFT):  $\pm 2.5$  kV /  $\pm 60$  A (5/50 ns)
  - IEC61000-4-5 (Surge):  $\pm 3.5$  A (8/20  $\mu$ s)
- Bi-directional working voltage up to:  $V_{RWM} = \pm 5.5$  V
- Line capacitance:  $C_L = 0.23$  pF (typical) at  $f = 1$  MHz
- Clamping voltage:  $V_{CL} = 13$  V (typical) at  $I_{TLP} = 16$  A with  $R_{DYN} = 0.66 \Omega$  (typical)
- Very low reverse current:  $I_R < 100$  nA (max.)
- Small form factor SMD size 0201 and low profile (0.58 mm x 0.28 mm x 0.15 mm)
- Bidirectional and symmetric I/V characteristics for optimized design and assembly
- Pb-free (RoHS compliant) and halogen free package



Guidelines for optimized PCB design and assembly process are available in [\[2\]](#).

## Product validation

Qualified for industrial applications according to the relevant tests of JEDEC47/20/22

## Application examples

- USB 3.0, Firewire, DVI, HDMI, S-ATA, DisplayPort, Thunderbolt
- Mobile HDMI Link, MDDI, MIPI, SWP / NFC

## Device information

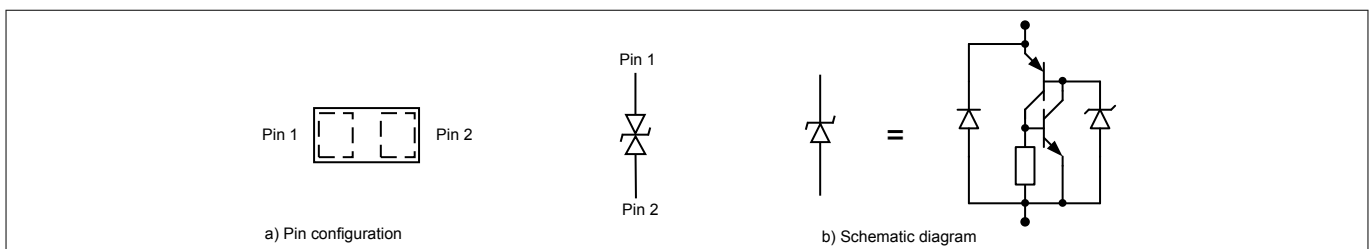

**Figure 1** Pin configuration and schematic diagram

**Table 1** Part information

Type	Package	Configuration	Marking code
ESD131-B1-W0201	WLL-2-3	1 line, bi-directional	T <sup>1)</sup>

<sup>1</sup> The device does not have any marking on the device top. The marking code is between the pads.

## Table of contents

	<b>Features</b> .....	1
	<b>Product validation</b> .....	1
	<b>Application examples</b> .....	1
	<b>Device information</b> .....	1
	<b>Table of contents</b> .....	2
<b>1</b>	<b>Maximum ratings</b> .....	3
<b>2</b>	<b>Electrical characteristics</b> .....	4
<b>3</b>	<b>Typical characteristic diagrams</b> .....	6
<b>4</b>	<b>Package information</b> .....	12
4.1	WLL-2-3 Package .....	12
<b>5</b>	<b>References</b> .....	13
	<b>Revision history</b> .....	13
	<b>Trademarks</b> .....	14

---

Maximum ratings

## 1 Maximum ratings

Note:  $T_A = 25\text{ °C}$ , unless otherwise specified<sup>1)</sup>

Table 2 Maximum ratings

Parameter	Symbol	Values	Unit
Reverse working voltage	$V_{RWM}$	$\pm 5.5$	V
ESD discharge <sup>2)</sup>	$V_{ESD}$ (contact)	$\pm 20$	kV
	$V_{ESD}$ (air)	$\pm 20$	
Peak pulse power <sup>3)</sup>	$P_{PK}$	26	W
Peak pulse current <sup>3)</sup>	$I_{PP}$	$\pm 3.5$	A
Operating temperature range	$T_{OP}$	-55 to 125	°C
Storage temperature	$T_{stg}$	-65 to 150	°C

**Attention:** Stresses above the max. values listed here may cause permanent damage to the device. Exposure to absolute maximum rating conditions for extended periods may affect device reliability. Maximum ratings are absolute ratings. Exceeding only one of these values may cause irreversible damage to the component.

---

<sup>1</sup> Device is electrically symmetrical

<sup>2</sup>  $V_{ESD}$  according to IEC61000-4-2 (R = 330  $\Omega$ , C = 150 pF discharge network)

<sup>3</sup> Stress pulse: 8/20 $\mu$ s current waveform according to IEC61000-4-5

Electrical characteristics

2 Electrical characteristics

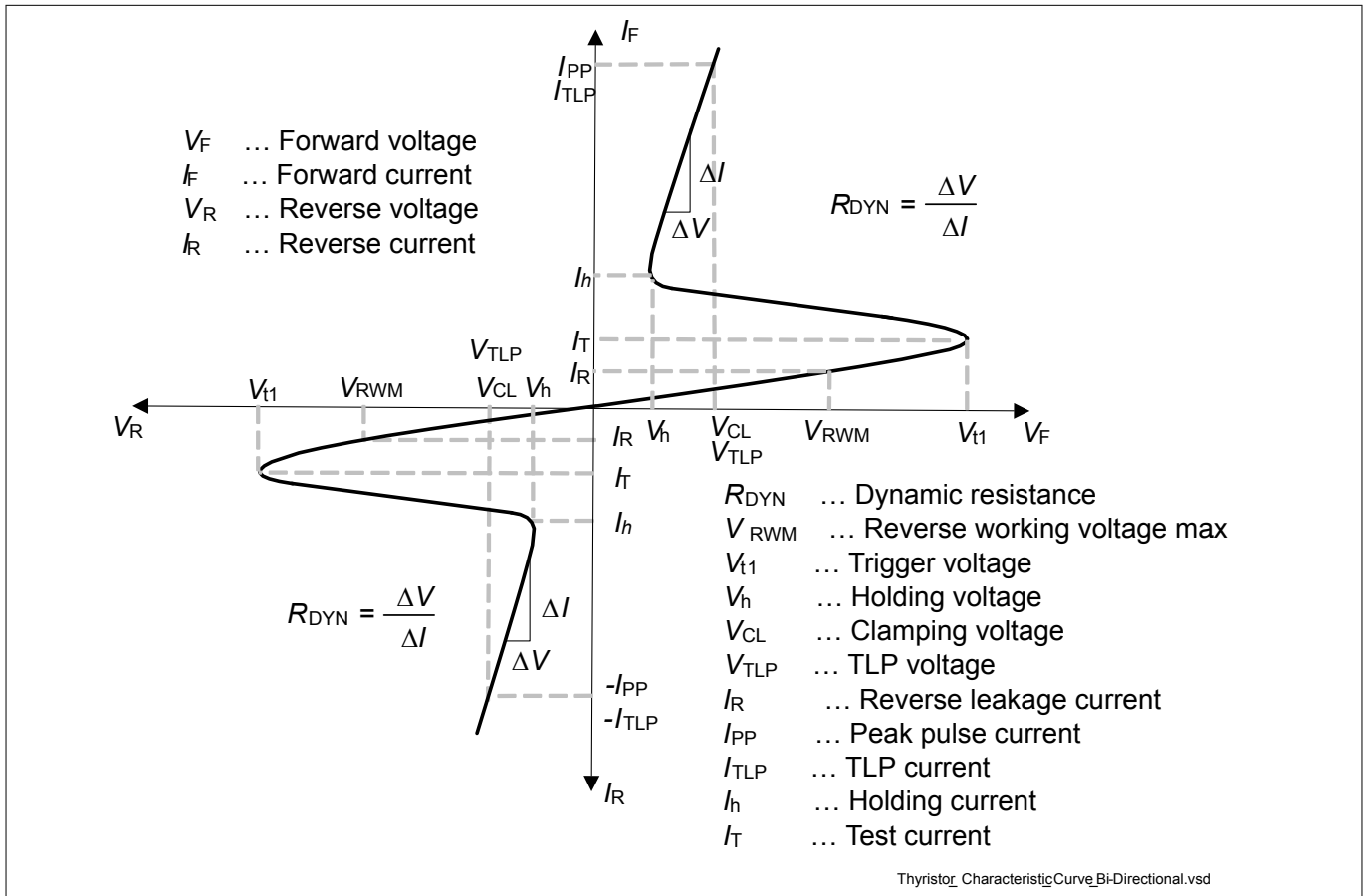

Figure 2 Definitions of electrical characteristics

**Electrical characteristics**

**Table 3 DC characteristics ( $T_A = 25\text{ °C}$ , unless otherwise specified) <sup>1)</sup>**

Parameter	Symbol	Values			Unit	Note or test condition
		Min.	Typ.	Max.		
Breakdown voltage	$V_{br}$	6	8	10.5	V	$I_R = 1\text{ mA}$
Holding voltage	$V_h$	–	1.9	–	V	$I_R = I_h$
Holding reverse current	$I_h$	–	25	–	mA	$V_R = V_h$
Reverse current	$I_R$	–	–	100	nA	$V_R = 5.5\text{ V}$

**Table 4 AC characteristics ( $T_A = 25\text{ °C}$ , unless otherwise specified)**

Parameter	Symbol	Values			Unit	Note or test condition
		Min.	Typ.	Max.		
Line capacitance	$C_L$	–	0.23	0.35	pF	$V_R = 0\text{ V}$ , $f = 1\text{ MHz}$
		–	0.20	–		$V_R = 0\text{ V}$ , $f = 2.5\text{ GHz}$

**Table 5 ESD and Surge characteristics ( $T_A = 25\text{ °C}$ , unless otherwise specified) <sup>1)</sup>**

Parameter	Symbol	Values			Unit	Note or test condition
		Min.	Typ.	Max.		
Clamping voltage <sup>2)</sup>	$V_{CL}$	–	8.5	–	V	$I_{TLP} = 8\text{ A}$ , $t_p = 100\text{ ns}$
		–	13	–		$I_{TLP} = 16\text{ A}$ , $t_p = 100\text{ ns}$
Clamping voltage <sup>3)</sup>	$V_{CL}$	–	3	–		$I_{PP} = 1\text{ A}$ , $t_p = 8/20\text{ }\mu\text{s}$
		–	5.5	–		$I_{PP} = 3\text{ A}$ , $t_p = 8/20\text{ }\mu\text{s}$
Dynamic resistance <sup>2)</sup>	$R_{DYN}$	–	0.66	–	$\Omega$	$t_p = 100\text{ ns}$

<sup>1</sup> Device is electrically symmetrical

<sup>2</sup> Please refer to Application Note AN210 [1]. TLP parameters:  $Z_0 = 50\text{ }\Omega$ ,  $t_p = 100\text{ ns}$ ,  $t_r = 0.6\text{ ns}$ .

<sup>3</sup> Stress pulse: 8/20 $\mu\text{s}$  current waveform according to IEC61000-4-5

Typical characteristic diagrams

### 3 Typical characteristic diagrams

Note:  $T_A = 25\text{ }^\circ\text{C}$ , unless otherwise specified

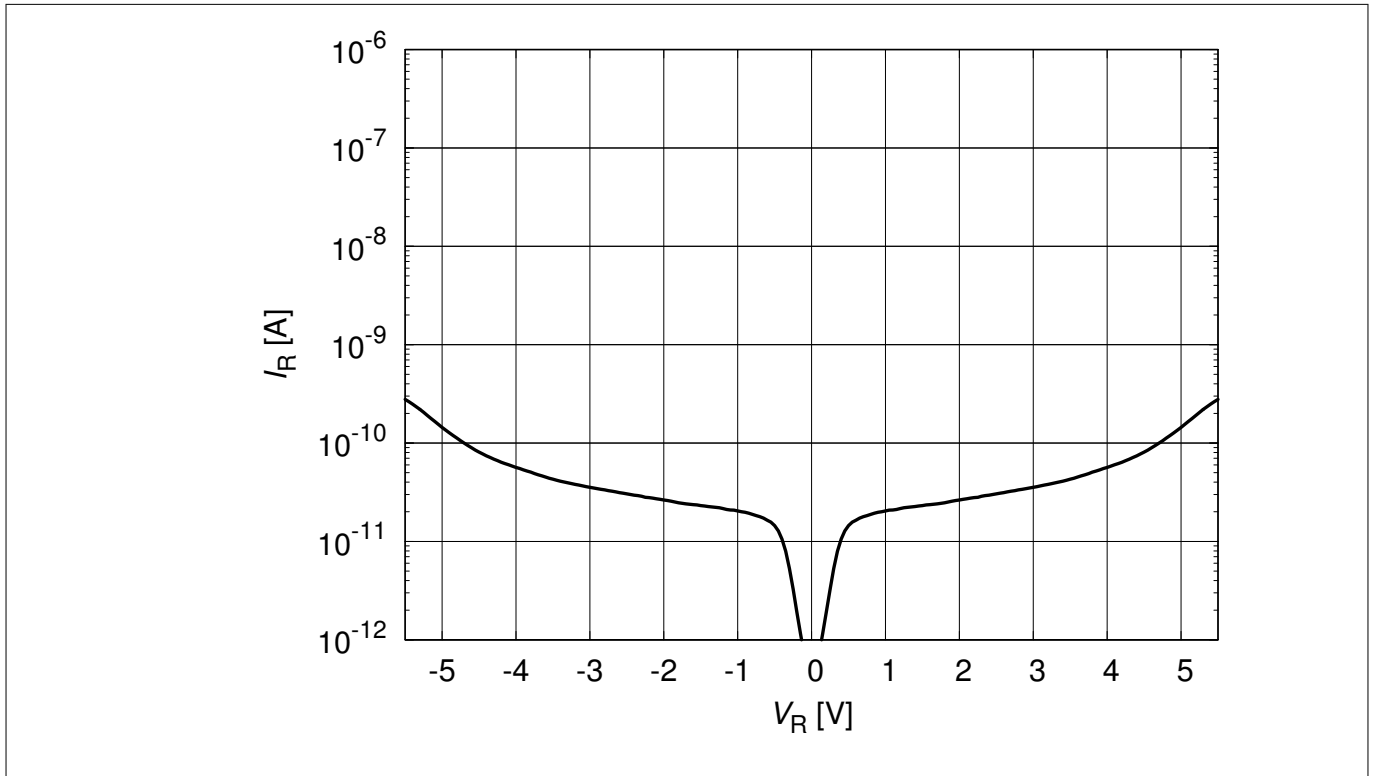

Figure 3 Reverse leakage current:  $I_R = f(V_R)$

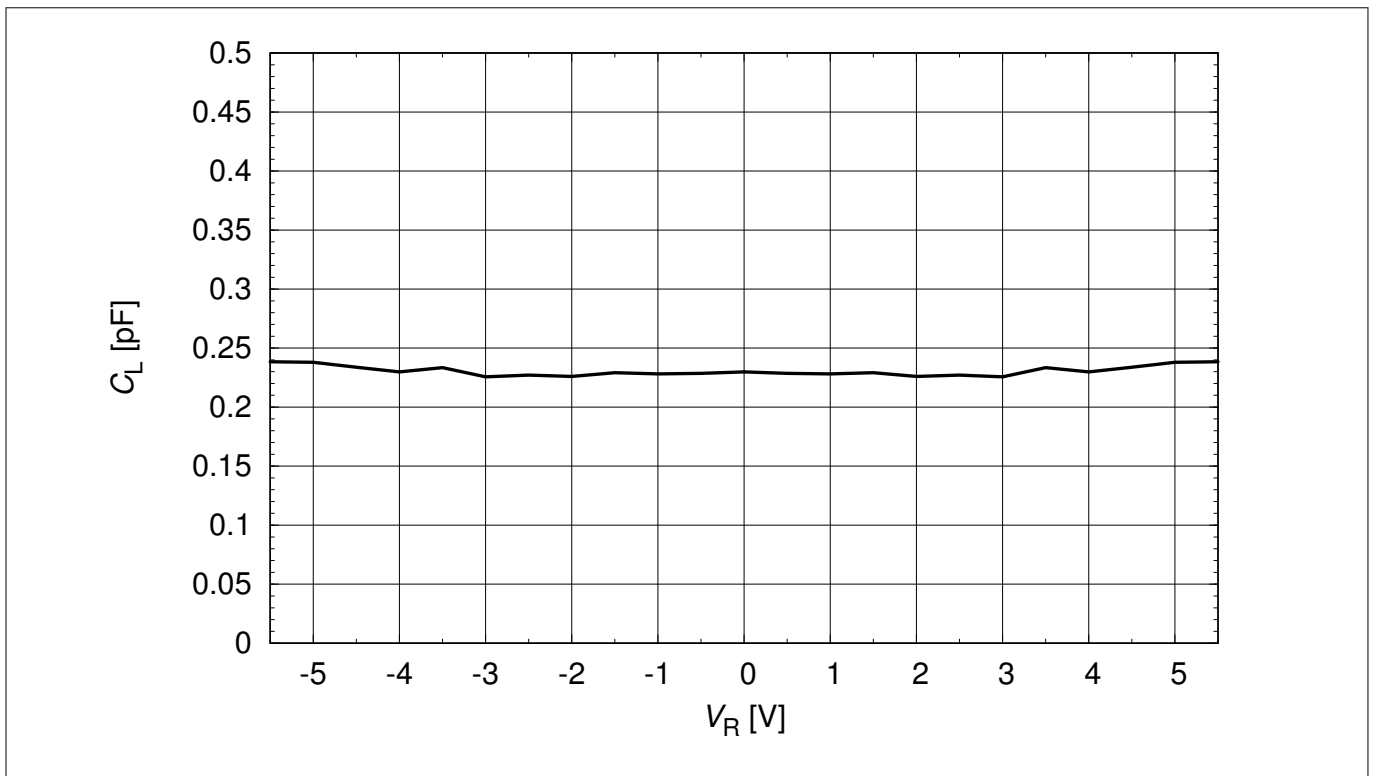

Figure 4 Line capacitance:  $C_L = f(V_R)$ ,  $f = 1\text{ MHz}$

Typical characteristic diagrams

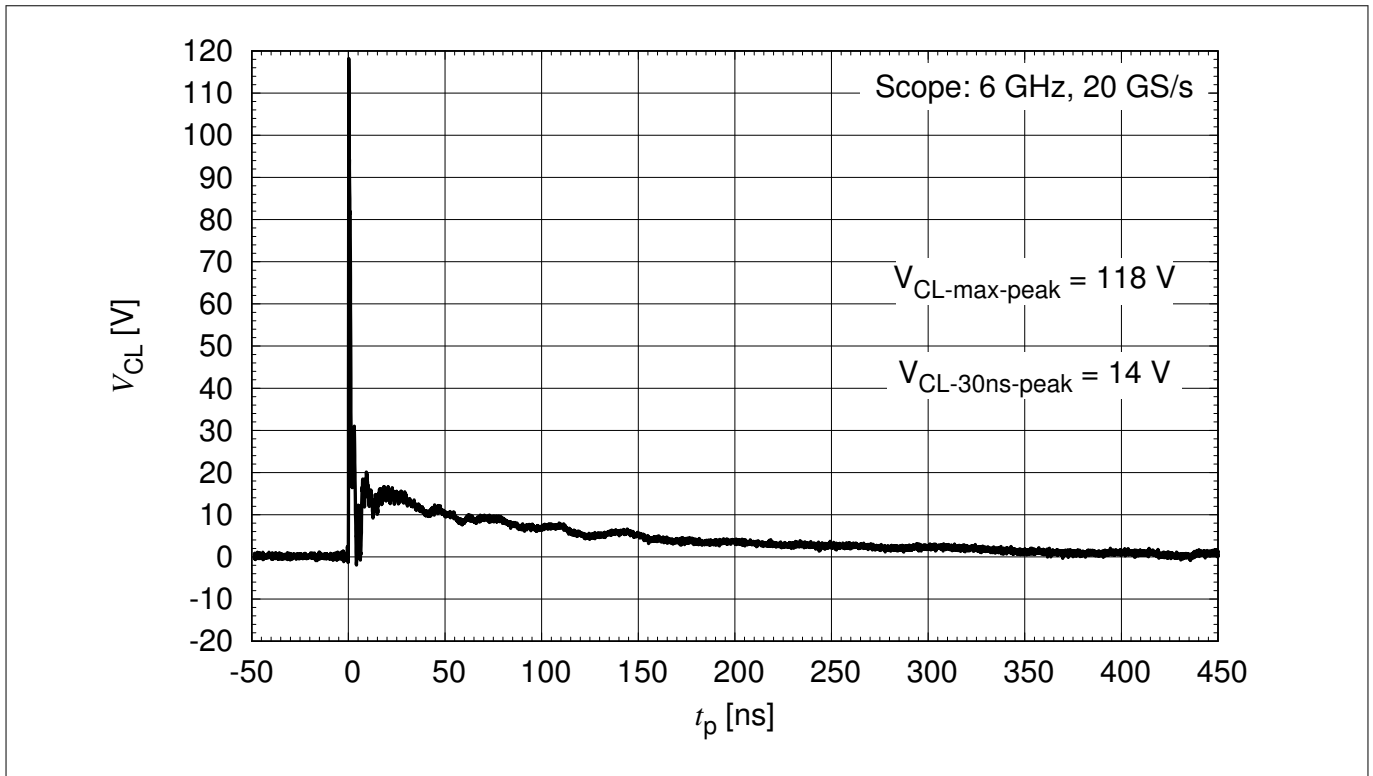

Figure 5 Clamping voltage (ESD):  $V_{CL} = f(t)$ , 8 kV positive pulse according to IEC61000-4-2

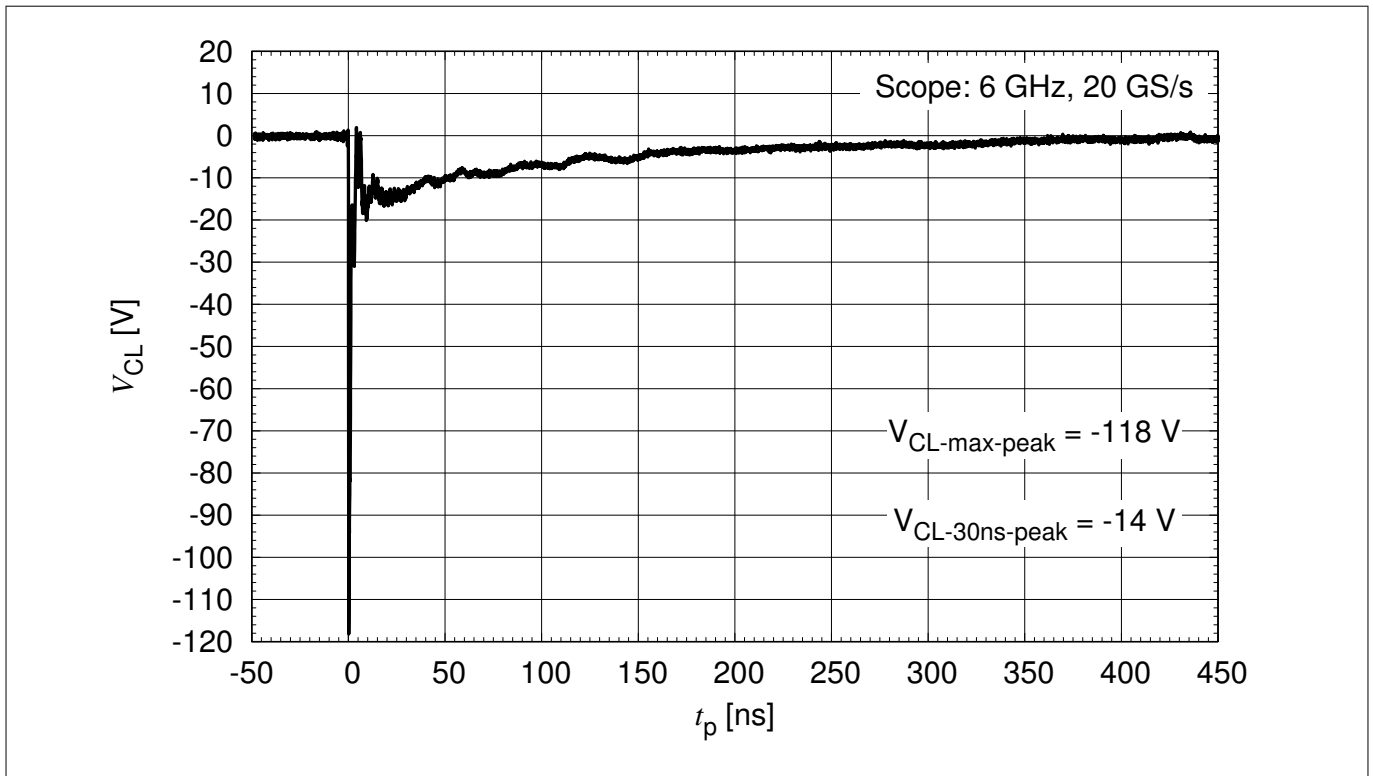

Figure 6 Clamping voltage (ESD):  $V_{CL} = f(t)$ , 8 kV negative pulse according to IEC61000-4-2

Typical characteristic diagrams

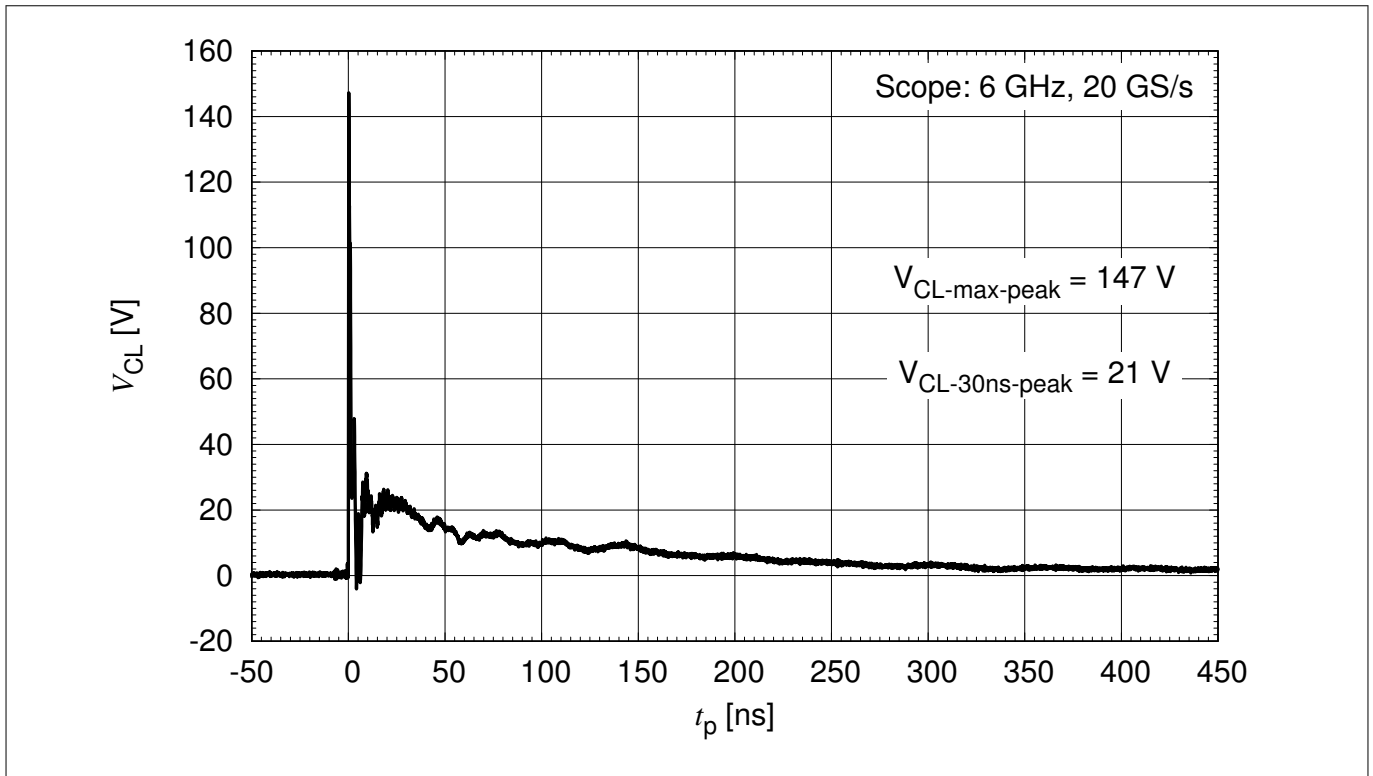

Figure 7 Clamping voltage (ESD):  $V_{CL} = f(t)$ , 15 kV positive pulse according to IEC61000-4-2

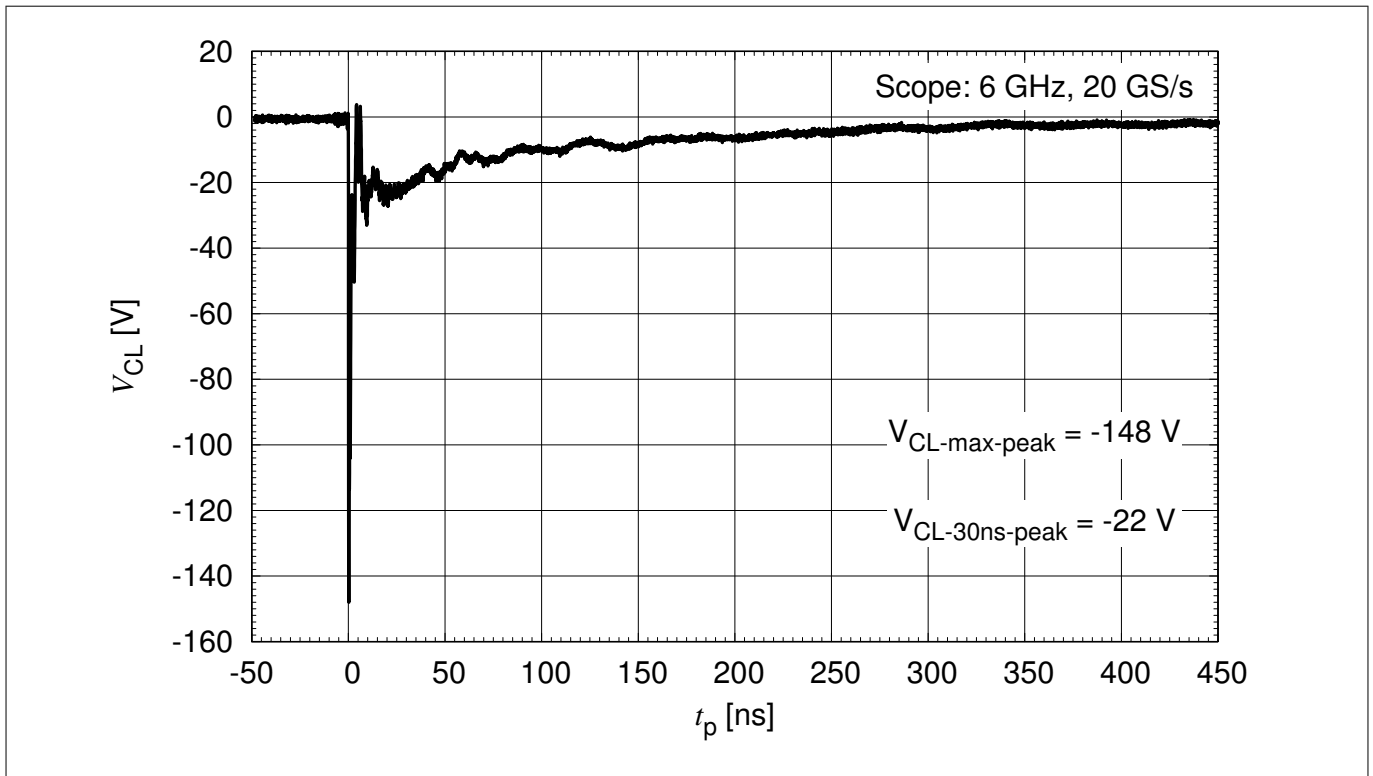
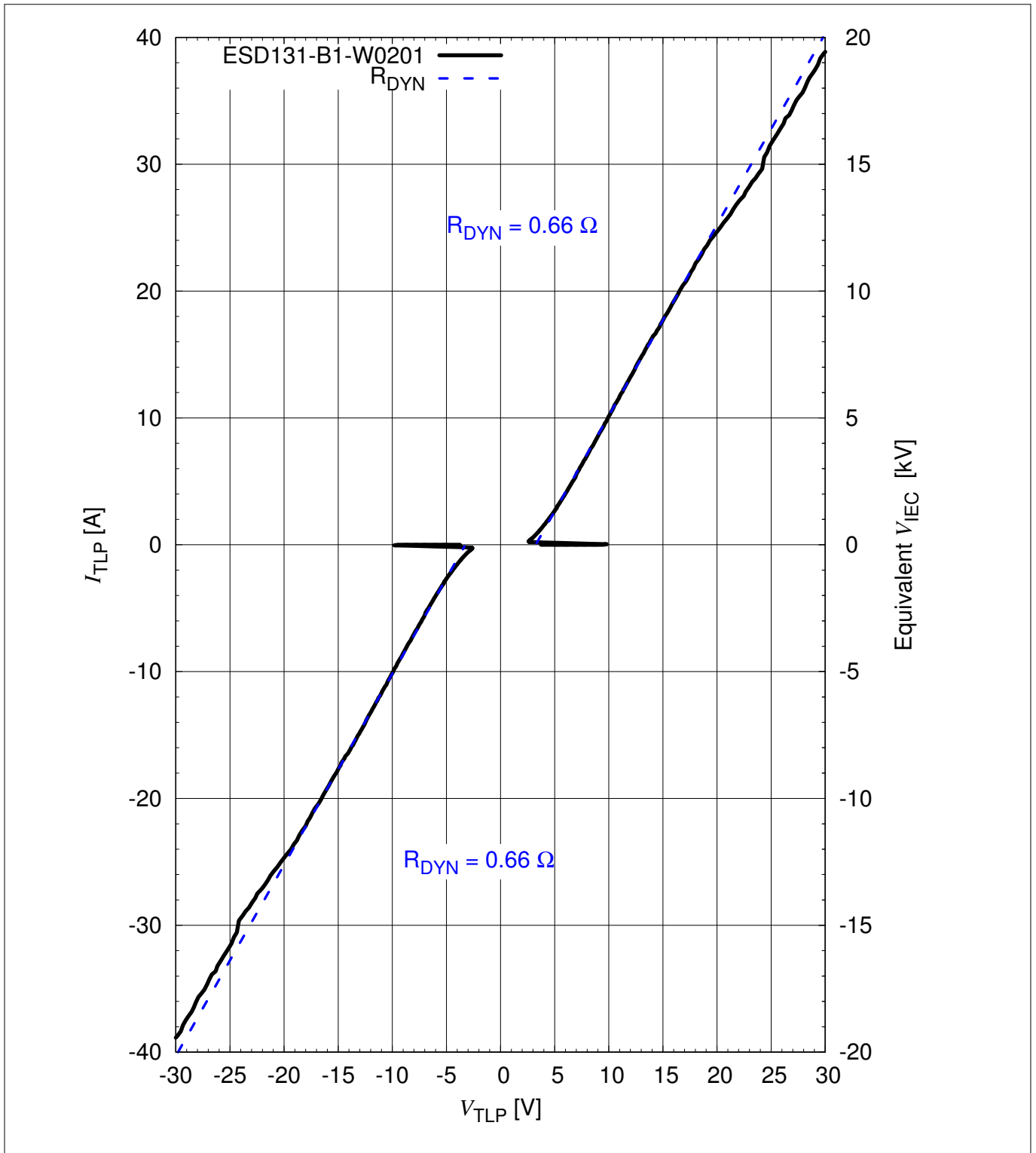

Figure 8 Clamping voltage (ESD):  $V_{CL} = f(t)$ , 15 kV negative pulse according to IEC61000-4-2



**Typical characteristic diagrams**



**Figure 9 Clamping voltage (TLP):  $I_{TLP} = f(V_{TLP})$  [1]**

Typical characteristic diagrams

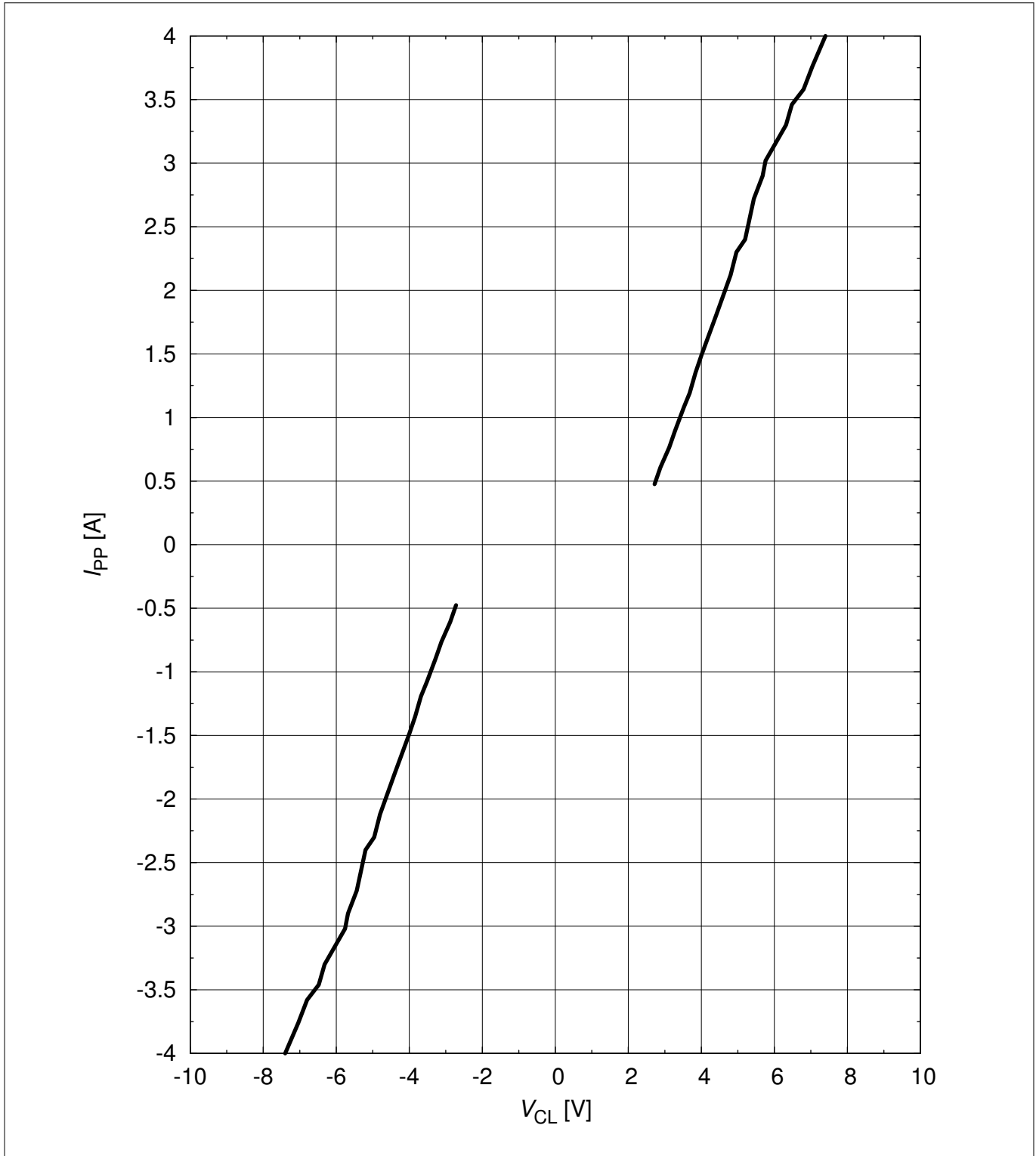

Figure 10 Clamping voltage (Surge):  $I_{PP} = f(V_{CL})$  according to IEC61000-4-5 [1]

Typical characteristic diagrams

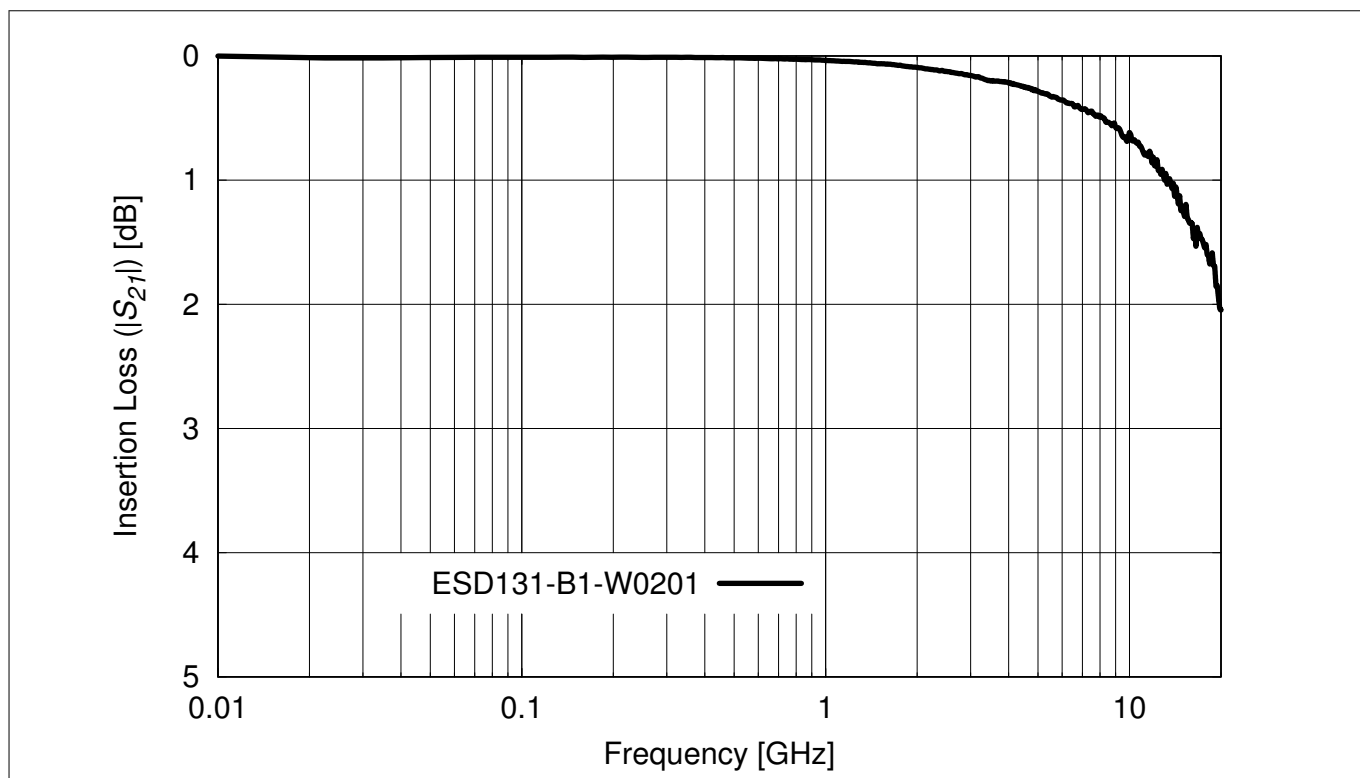

Figure 11 Insertion loss vs. frequency in a 50  $\Omega$  system

Package information

## 4 Package information

### 4.1 WLL-2-3 Package

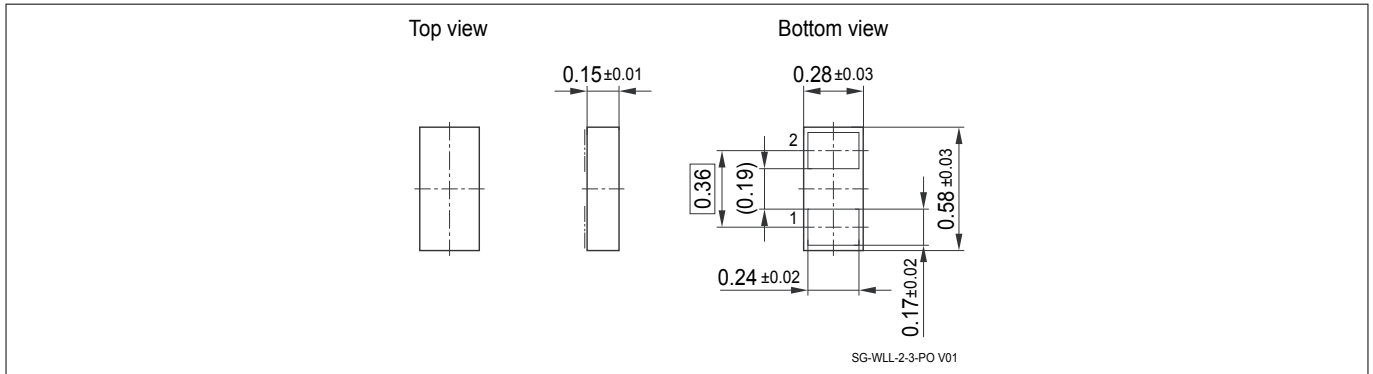

Figure 12 WLL-2-3 package outline (dimension in mm)

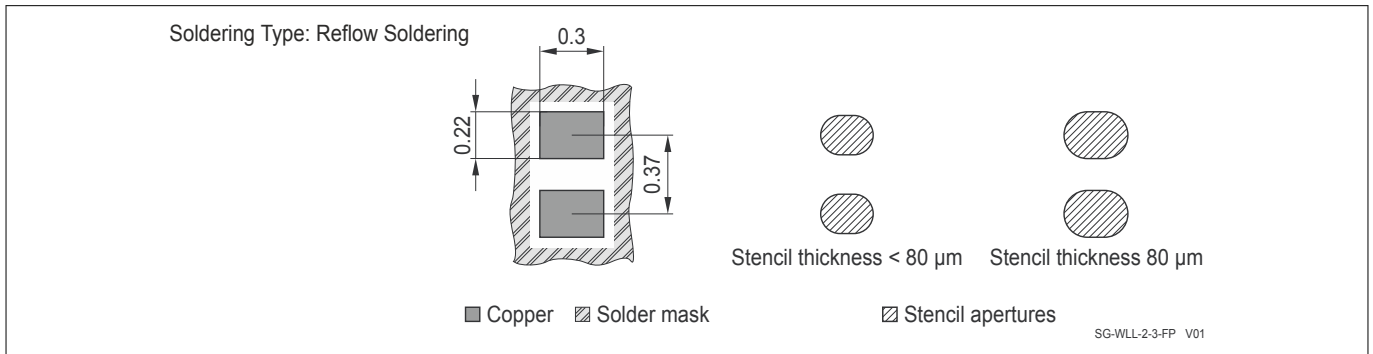

Figure 13 WLL-2-3 footprint (dimension in mm), recommendation for Printed Circuit Board Assembly see [2]

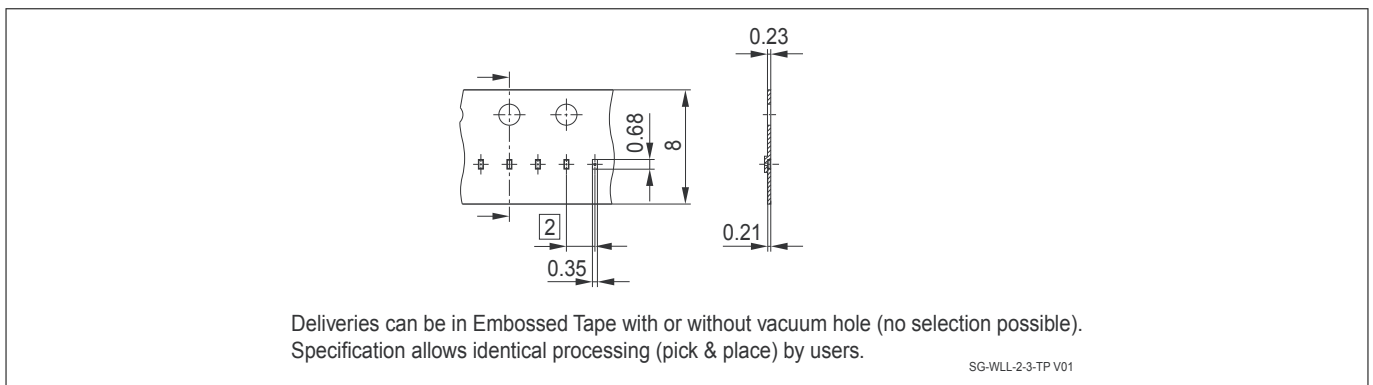

Figure 14 WLL-2-3 packing (dimension in mm)

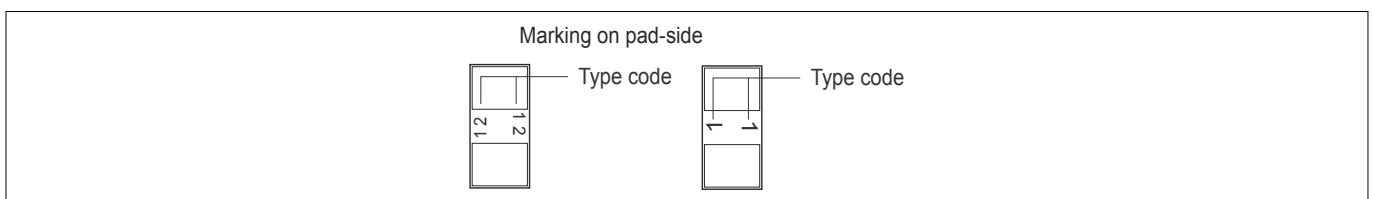

Figure 15 WLL-2-3 marking example (see Table 1)

---

**References**

## **5                   References**

- [1] Infineon AG - **Application Note AN210**: Effective ESD Protection design at System Level Using VF-TLP Characterization Methodology
- [2] Infineon AG - Recommendation for Printed Circuit Board Assembly of Infineon WLL Packages  
[http://www.infineon.com/Packageinformation\\_WLL](http://www.infineon.com/Packageinformation_WLL)
- [3] Infineon AG - **Application Note AN392**: TVS Diodes in ChipScalePackage reduce size and save cost

## **Revision history**

---

**Revision history: Rev.0.9, 2016-04-21**

<b>Page or Item</b>	<b>Subjects (major changes since previous revision)</b>
Revision 1.0, 2017-03-22	
Tables 2, 3, 4	Values updated
	Missing figures added

## Trademarks of Infineon Technologies AG

$\mu$ HVIC™,  $\mu$ IPM™,  $\mu$ PFC™, AU-ConvertIR™, AURIX™, C166™, CanPAK™, CIPOS™, CIPURSE™, CoolDP™, CoolGaN™, COOLiR™, CoolMOS™, CoolSET™, CoolSiC™, DAVE™, DI-POL™, DirectFET™, DrBlade™, EasyPIM™, EconoBRIDGE™, EconoDUAL™, EconoPACK™, EconoPIM™, EiceDRIVER™, eupec™, FCOS™, GaNpowIR™, HEXFET™, HITFET™, HybridPACK™, iMOTION™, IRAM™, ISOFACE™, IsoPACK™, LEDriviR™, LITIX™, MIPAQ™, ModSTACK™, my-d™, NovalithIC™, OPTIGA™, OptiMOS™, ORIGA™, PowIRaudio™, PowIRstage™, PrimePACK™, PrimeSTACK™, PROFET™, PRO-SIL™, RASIC™, REAL3™, SmartLEWIS™, SOLID FLASH™, SPOC™, StrongIRFET™, SuplIRBuck™, TEMPFET™, TRENCHSTOP™, TriCore™, UHVIC™, XHP™, XMC™.

Trademarks Update 2015-12-22

## Other Trademarks

All referenced product or service names and trademarks are the property of their respective owners.

**Edition 2017-03-27**

**Published by**  
**Infineon Technologies AG**  
**81726 Munich, Germany**

**© 2017 Infineon Technologies AG**  
**All Rights Reserved.**

**Do you have a question about any aspect of this document?**

**Email: [erratum@infineon.com](mailto:erratum@infineon.com)**

**Document reference**  
**IFX-jaj1475144300545**

## IMPORTANT NOTICE

The information given in this document shall in no event be regarded as a guarantee of conditions or characteristics ("Beschaffenhheitsgarantie").

With respect to any examples, hints or any typical values stated herein and/or any information regarding the application of the product, Infineon Technologies hereby disclaims any and all warranties and liabilities of any kind, including without limitation warranties of non-infringement of intellectual property rights of any third party.

In addition, any information given in this document is subject to customer's compliance with its obligations stated in this document and any applicable legal requirements, norms and standards concerning customer's products and any use of the product of Infineon Technologies in customer's applications.

The data contained in this document is exclusively intended for technically trained staff. It is the responsibility of customer's technical departments to evaluate the suitability of the product for the intended application and the completeness of the product information given in this document with respect to such application.

## WARNINGS

Due to technical requirements products may contain dangerous substances. For information on the types in question please contact your nearest Infineon Technologies office.

Except as otherwise explicitly approved by Infineon Technologies in a written document signed by authorized representatives of Infineon Technologies, Infineon Technologies' products may not be used in any applications where a failure of the product or any consequences of the use thereof can reasonably be expected to result in personal injury