

# RM84 / RM85 / RM87

## Miniature Electromagnetic Relays



- Miniature dimensions
- 5000 V / 10 mm reinforced insulation
- Available special versions with the increased dielectric strength of the contact clearance
- IP67 flux proof, water proof and sealed cover protection (For IP40 unsealed, contact Altech)
- Cadmium - free contacts
- For PCB and plug-in sockets

Contact Data		RM84	RM85	RM87
<b>No. and type of contacts</b>		<b>DPDT, DPST (2NO)</b>	<b>SPDT, SPST (1NO)</b>	<b>SPDT, SPST (1NO)</b>
Contact material		AgNi	AgNi	AgNi
Rated / max. switching voltage	AC	250 V / 440 V	250 V / 440 V	250 V / 440 V
Min. switching voltage		5 V	5 V	5 V
Rated load (capacity)		8 A / 250 V AC	16 A / 250 V AC	12 A / 250 V AC
	AC15	3 A / 120 V; 1.5 A / 240 V (B300)	3 A / 120 V; 1.5 A / 240 V (B300)	3 A / 120 V; 1.5 A / 240 V (B300)
	AC3	550 W (single-phase motor)	750 W (single-phase motor)	750 W (single-phase motor)
	DC1	8 A / 24 V DC (see Fig. 3.1)	16 A / 24 V DC (see Fig. 3.2)	12 A / 24 V DC (see Fig. 3.3)
	DC13	0.22 A / 120 V; 0.1 A / 250 V (R300)	0.22 A / 120 V; 0.1 A / 250 V (R300)	0.22 A / 120 V; 0.1 A / 250 V (R300)
Min. switching current		5 mA	5 mA	5 mA
Max. inrush current		12 A	24 A	18 A
<b>Rated current</b>		<b>8 A</b>	<b>16 A</b>	<b>12 A</b>
Max. breaking capacity	AC1	2 000 VA	4 000 VA	3 000 VA
Min. breaking capacity		0.3 W	0.3 W	0.3 W
Contact resistance		≤ 100 mΩ	≤ 100 mΩ	≤ 100 mΩ
Max. operating frequency		600 cycles/hour	600 cycles/hour	600 cycles/hour
	• at rated load	72000 cycles/hour	72000 cycles/hour	72000 cycles/hour
	• no load			
<b>Coil Data</b>				
Rated voltage	50/60 Hz AC	12 ... 240 V	12 ... 240 V	12 ... 240 V
	DC	3 ... 110 V	3 ... 110 V	3 ... 110 V
Must release voltage		AC: ≥ 0.15 U <sub>N</sub> ; DC: ≥ 0.1 U <sub>N</sub>	AC: ≥ 0.15 U <sub>N</sub> ; DC: ≥ 0.1 U <sub>N</sub>	AC: ≥ 0.15 U <sub>N</sub> ; DC: ≥ 0.1 U <sub>N</sub>
Operating range of supply voltage		see page 80 and Fig. 4.1. 5.1	see page 80 and Fig. 4.2. 5.2	see page 80 and Fig. 4.3. 5.3
Rated power consumption	AC	0.75 VA	0.75 VA	0.75 VA
	DC	0.4 ... 0.48 W	0.4 ... 0.48 W	0.4 ... 0.48 W
<b>Insulation</b>				
Insulation rated voltage		400 V AC	400 V AC	400 V AC
Rated surge voltage		4000 V 1.2 / 50 μs	4000 V 1.2 / 50 μs	4000 V 1.2 / 50 μs
Overvoltage category		III	III	III
Insulation pollution degree		3	3	3
Dielectric strength		5000 V AC type of insulation: reinforced	5000 V AC type of insulation: reinforced	5000 V AC type of insulation: reinforced
	• between coil and contacts	1000 V AC type of clearance: micro-disconnection	1000 V AC type of clearance: micro-disconnection	1000 V AC type of clearance: micro-disconnection
	• contact clearance	2000 V AC contacts DPST (2NO). type of clearance: full-disconnect	2000 V AC contacts DPST (2NO). type of clearance: full-disconnect	2000 V AC contacts SPST (1NO). type of clearance: full-disconnect
	• pole - pole	2500 V AC type of insulation: basic	-	-
Contact - coil distance		≥ 10 mm	≥ 10 mm	≥ 10 mm
	• clearance	≥ 10 mm	≥ 10 mm	≥ 10 mm
	• creepage			
<b>General data</b>				
Operating / release time (typical values)		7 ms / 3 ms	7 ms / 3 ms	7 ms / 3 ms
Electrical life				
	• resistive	> 10 <sup>6</sup> ; 8 A. 250 V AC	> 0.7 x 10 <sup>6</sup> ; 16 A. 250 V AC	> 10 <sup>6</sup> ; 12 A. 250 V AC
	• cosφ	see Fig. 2.1	see Fig. 2.2	see Fig. 2.3
	• DC L/R=40 ms	> 10 <sup>6</sup> ; 0.15 A. 220 V DC	> 10 <sup>6</sup> ; 0.15 A. 220 V DC	> 10 <sup>6</sup> ; 0.15 A. 220 V DC
Mechanical life (cycles)		> 3 x 10 <sup>7</sup>	> 3 x 10 <sup>7</sup>	> 3 x 10 <sup>7</sup>
Dimensions (L x W x H)		29 x 12.7 x 15.7 mm	29 x 12.7 x 15.7 mm	29 x 12.7 x 15.7 mm
Weight		14 g	14 g	14 g
Ambient temperature				
	• storage	-40...+85 °C	40...+85 °C	40...+85 °C
	• operating	AC: -40...+70 °C DC: -40...+85 °C	AC: -40...+70 °C DC: -40...+85 °C	AC: -40...+70 °C DC: -40...+85 °C
Cover protection category		IP 67 PN-EN 60529	IP 67 PN-EN 60529	IP 67 PN-EN 60529
Environmental protection		RTIII PN-EN 116000-3	RTIII PN-EN 116000-3	RTIII PN-EN 116000-3
Shock resistance (NO/NC)		20 g	30 g	30 g
Vibration resistance		10 g / 5 g 10...150 Hz	10 g 10...150 Hz	10 g 10...150 Hz
Solder bath temperature		max. 270 °C	max. 270 °C	max. 270 °C
Soldering time		max. 5 s	max. 5 s	max. 5 s

# RM84 / RM85 / RM87

## Miniature Electromagnetic Relays



**RM84**



### CONNECTION DIAGRAM



Terminal (pin)	A1(1); A2(2)	22(3); 21(4); 24(5); 12(6); 11(7); 14(8)
[mm]	∅ 0.6	0.5 x 0.9
Drilling hole:		
• for relays	∅ 1.3 + 0.1 mm	
• for sockets	∅ 1.5 + 0.1 mm	

### DIMENSIONS



### LOAD CHARTS

**Electrical life at AC resistive load.** Switching frequency: 600 cycles/hour      Fig. 1.1



**Electrical life reduction factor at AC inductive load**      Fig. 2.1



**Max. DC resistive load breaking capacity**      Fig. 3.1



**Coil operating range - DC**      Fig. 4.1



**Coil operating range - AC 50 Hz**      Fig. 5.1



#### Description of Fig. 4.1 and 5.1

**A** - relations between make voltage and ambient temperature at no load on contacts. Coil temperature and ambient temperature are equal before coil energizing. Make voltage is not higher than the value read on Y axis (multiplication of rated voltage).  
**B** - relations between make voltage and ambient temperature after initial coil heating up with 1.1 U<sub>n</sub> at continues load of I<sub>n</sub> on contacts. Make voltage is not higher than the value read on Y axis (multiplication of rated voltage).  
 1, 2, 3 - values on Y axis represent allowed overvoltage on coil at certain ambient temperature and contact load:  
 1 - no load  
 2 - 50% of rated load  
 3 - rated load

# RM84 / RM85 / RM87

## Miniature Electromagnetic Relays



**RM85**



### CONNECTION DIAGRAM



Terminal (pin)	A1(1); A2(2)	22(3); 21(4); 24(5); 12(6); 11(7); 14(8)
[mm]	∅ 0.6	0.5 x 0.9
Drilling hole:		
• for relays	∅ 1.3 + 0.1 mm	
• for sockets	∅ 1.5 + 0.1 mm	

**RM85** terminals are doubled for each contact.  
Both terminals are to be used while connecting to load.

### DIMENSIONS



### LOAD CHARTS

**Electrical life at AC resistive load.**  
Switching frequency: 600 cycles/hour Fig. 1.2



**Electrical life reduction factor at AC inductive load** Fig. 2.2



**Max. DC resistive load breaking capacity** Fig. 3.2



**Coil operating range - DC** Fig. 4.2



**Coil operating range - AC 50 Hz** Fig. 5.2



#### Description of Fig. 4.2 and 5.2

**A** - relations between make voltage and ambient temperature at no load on contacts. Coil temperature and ambient temperature are equal before coil energizing. Make voltage is not higher than the value read on Y axis (multiplication of rated voltage).  
**B** - relations between make voltage and ambient temperature after initial coil heating up with  $1.1 U_n$  at continues load of  $I_n$  on contacts. Make voltage is not higher than the value read on Y axis (multiplication of rated voltage).  
**1, 2, 3** - values on Y axis represent allowed overvoltage on coil at certain ambient temperature and contact load:  
**1** - no load  
**2** - 50% of rated load  
**3** - rated load

# RM84 / RM85 / RM87

## Miniature Electromagnetic Relays



**RM87**



### CONNECTION DIAGRAM



Terminal (pin)	A1(1); A2(2)	12(3); 11(4); 14(5)
[mm]	Ø 0.6	0.5 x 0.9
Drilling hole:		
• for relays	Ø 1.3 + 0.1 mm	
• for sockets	Ø 1.5 + 0.1 mm	

### DIMENSIONS



### LOAD CHARTS

**Electrical life at AC resistive load.** Fig. 1.3  
Switching frequency: 600 cycles/hour



**Electrical life reduction factor at AC inductive load** Fig. 2.3



**Max. DC resistive load breaking capacity** Fig. 3.3  
- standard version

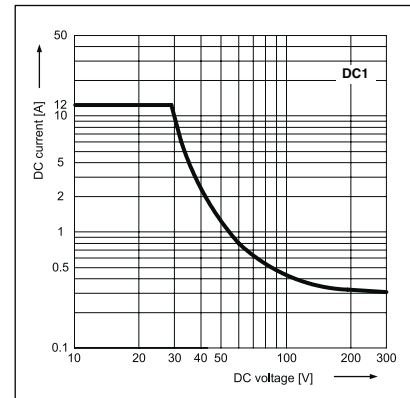

**Coil operating range - DC** Fig. 4.3  
- standard version



**Coil operating range - AC 50 Hz** Fig. 5.3



**Description of Fig. 4.3 and 5.3**

**A** - relations between make voltage and ambient temperature at no load on contacts. Coil temperature and ambient temperature are equal before coil energizing. Make voltage is not higher than the value read on Y axis (multiplication of rated voltage). **B** - relations between make voltage and ambient temperature after initial coil heating up with 1,1 U<sub>n</sub> at continues load of I<sub>n</sub> on contacts. Make voltage is not higher than the value read on Y axis (multiplication of rated voltage).  
1, 2, 3 - values on Y axis represent allowed overvoltage on coil at certain ambient temperature and contact load: 1 - no load; 2 - 50% of rated load; 3 - rated load

# RM84 / RM85 / RM87

## Miniature Electromagnetic Relays

### R84 DPDT AC 50/60Hz & DC coil

Part Number	Coil Voltage (V)	Coil Type	Coil resistance at 20 °C in Ω	Coil operating range	
				min. (at 20°C)	max. (at 55°C)
▶ <b>RM84-2012-35-1012</b>	12	DC	360	8.4	30.6
▶ <b>RM84-2012-35-1024</b>	24	DC	1440	16.8	61.2
▶ RM84-2012-35-1110	110	DC	25200	77.0	280.0
▶ <b>RM84-2012-35-5120</b>	120	AC 50/60Hz	10200	96.0	144.0
▶ <b>RM84-2012-35-5230</b>	230	AC 50/60Hz	38500	184.0	276.0

### R84 DPST(2NO) AC 50/60Hz & DC coil

Part Number	Coil Voltage (V)	Coil Type	Coil resistance at 20 °C in Ω	Coil operating range	
				min. (at 20°C)	max. (at 55°C)
▶ <b>RM84-2022-35-1012</b>	12	DC	360	8.4	30.6
▶ <b>RM84-2022-35-1024</b>	24	DC	1440	16.8	61.2
▶ RM84-2022-35-1110	110	DC	25200	77.0	280.0
▶ <b>RM84-2022-35-5120</b>	120	AC 50/60Hz	10200	96.0	144.0
▶ <b>RM84-2022-35-5230</b>	230	AC 50/60Hz	38500	184.0	276.0

### R85 SPDT AC 50/60Hz & DC coil

Part Number	Coil Voltage (V)	Coil Type	Coil resistance at 20 °C in Ω	Coil operating range	
				min. (at 20°C)	max. (at 55°C)
▶ <b>RM85-2011-35-1012</b>	12	DC	360	8.4	30.6
▶ <b>RM85-2011-35-1024</b>	24	DC	1440	16.8	61.2
▶ RM85-2011-35-1110	110	DC	25200	77.0	280.0
▶ <b>RM85-2011-35-5120</b>	120	AC 50/60Hz	10200	96.0	144.0
▶ <b>RM85-2011-35-5230</b>	230	AC 50/60Hz	38500	184.0	276.0

### R85 SPST(1NO) AC 50/60Hz & DC coil

Part Number	Coil Voltage (V)	Coil Type	Coil resistance at 20 °C in Ω	Coil operating range	
				min. (at 20°C)	max. (at 55°C)
▶ <b>RM85-2021-35-1012</b>	12	DC	360	8.4	30.6
▶ <b>RM85-2021-35-1024</b>	24	DC	1440	16.8	61.2
▶ RM85-2021-35-1110	110	DC	25200	77.0	280.0
▶ <b>RM85-2021-35-5120</b>	120	AC 50/60Hz	10200	96.0	144.0
▶ <b>RM85-2021-35-5230</b>	230	AC 50/60Hz	38500	184.0	276.0

### R87 SPDT AC 50/60Hz & DC coil

Part Number	Coil Voltage (V)	Coil Type	Coil resistance at 20 °C in Ω	Coil operating range	
				min. (at 20°C)	max. (at 55°C)
▶ <b>RM87N-2011-35-1012</b>	12	DC	360	8.4	30.6
▶ <b>RM87N-2011-35-1024</b>	24	DC	1440	16.8	61.2
▶ RM87N-2011-35-1110	110	DC	25200	77.0	280.0
▶ <b>RM87N-2011-35-5120</b>	120	AC 50/60Hz	10200	96.0	144.0
▶ <b>RM87N-2011-35-5230</b>	230	AC 50/60Hz	38500	184.0	276.0

### R87 SPST(1NO) AC 50/60Hz & DC coil

Part Number	Coil Voltage (V)	Coil Type	Coil resistance at 20 °C in Ω	Coil operating range	
				min. (at 20°C)	max. (at 55°C)
▶ <b>RM87N-2021-35-1012</b>	12	DC	360	8.4	30.6
▶ <b>RM87N-2021-35-1024</b>	24	DC	1440	16.8	61.2
▶ RM87N-2021-35-1110	110	DC	25200	77.0	280.0
▶ <b>RM87N-2021-35-5120</b>	120	AC 50/60Hz	10200	96.0	144.0
▶ <b>RM87N-2021-35-5230</b>	230	AC 50/60Hz	38500	184.0	276.0

\* waterproof version

▶ **BOLD** - Regular stocked items.

# RM84 / RM85 / RM87

## Miniature Electromagnetic Relays - Plug-in Sockets and Accessories

### GZT80 (for RM84 / RM85)

Screw terminals  
 Max. tightening moment  
 for the terminal: 0.7 Nm  
 35 mm rail mount  
 acc. to PN-EN 60715  
 or on panel mounting  
 75.3 x 15.5 x 61(67) mm\*  
 Two poles, 5 mm pinout  
 12 A, 300 V AC



#### CONNECTION DIAGRAM

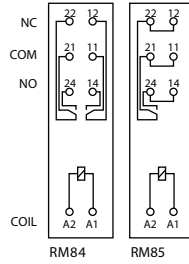

#### DIMENSIONS

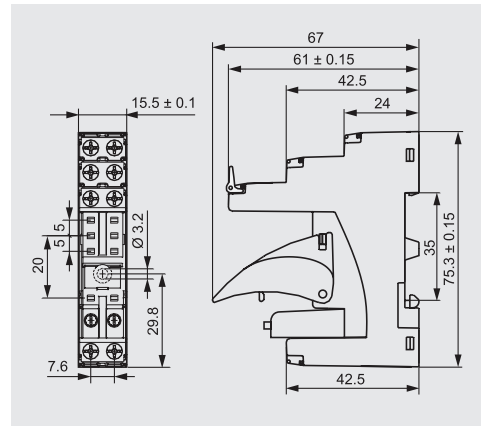

### GZM80 (for RM84 / RM85)

Screw terminals  
 Max. tightening moment  
 for the terminal: 0.7 Nm  
 35 mm rail mount  
 acc. to PN-EN 60715  
 or on panel mounting  
 78.1 x 15.9 x 61(66.5) mm\*  
 Two poles, 5 mm pinout  
 12 A, 300 V AC



#### CONNECTION DIAGRAM

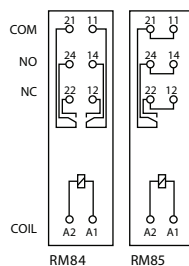

#### DIMENSIONS

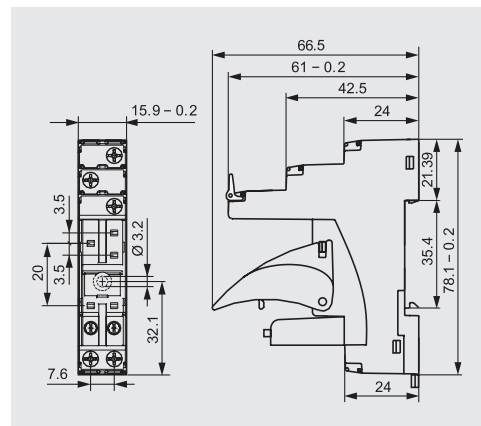

\* In parenthesis is the height of the socket with plastic retainer clip. \*\* For lower profile application.

All accessories are sold separately.

# RM84 / RM85 / RM87

## Miniature Electromagnetic Relays - Plug-in Sockets and Accessories

### GZT92 (for RM87)

Screw terminals  
 Max. tightening moment  
 for the terminal: 0.7 Nm  
 35 mm rail mount  
 acc. to PN-EN 60715  
 or on panel mounting  
 75.3 x 15.5 x 61(67) mm\*  
 One pole, 3,5 mm  
 12 A, 300 V AC



E22891



GZT92



ZGGZ80 (see page 110)

### CONNECTION DIAGRAM

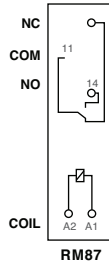

RM87

### DIMENSIONS



GZT80-0040



GZM80-0041\*\*



GZT80-0035



Module type M... (see page 113)

### GZM92 (for RM87)

Screw terminals  
 Max. tightening moment  
 for the terminal: 0.7 Nm  
 35 mm rail mount  
 acc. to PN-EN 60715  
 or on panel mounting  
 78.1 x 15.9 x 61(66.5) mm\*  
 One pole, 3,5 mm pinout  
 12 A, 300 V AC



E22891



GZM92



ZGGZ80 (see page 110)

### CONNECTION DIAGRAM

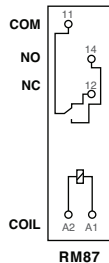

RM87

### DIMENSIONS



GZT80-0040



GZM80-0041\*\*



GZT80-0035



Module type M... (see page 113)

\* In parenthesis is the height of the socket with plastic retainer clip. \*\* For lower profile application.

All accessories are sold separately.

# RM84 / RM85 / RM87

## Miniature Electromagnetic Relays - Plug-in Sockets and Accessories

### GZMB80 (for RM84, RM85)

Spring terminals  
 Max. cross section of the cables:  
 1 x 0.2...1.5 mm<sup>2</sup>  
 (1 x 24...16 AWG)  
 Stripping length deinsulation:  
 9...11 mm  
 35 mm rail mount  
 acc. to PN-EN 60715  
 97 x 16 x 45.2(69) mm\*  
 Two poles, 5 mm pinout  
 10 A, 300 V AC



GZMB80

#### CONNECTION DIAGRAM



#### DIMENSIONS



GZMB80-0040



GZMB80-0041\*\*



TR



Module type M... (see page 113)

### GD50 (for RM84, RM85)

For RM84, RM85

For PCB  
 31.5 x 13 x 9 mm  
 Two poles, 5 mm pinout  
 8 A, 300 V AC



GD50

#### CONNECTION DIAGRAM



#### DIMENSIONS



MH16-2

### GD35 (for RM87N)

For RM87

For PCB  
 31.5 x 13 x 9 mm  
 One pole, 3.5 mm pinout  
 12 A, 300 V AC



GD35

#### CONNECTION DIAGRAM



#### DIMENSIONS



MH16-2

\* In parenthesis is the height of the socket with plastic retainer clip. \*\* For lower profile application.

All accessories are sold separately.