

30V Buck-Boost Charger with Integrated MOSFETs and OTG

BENEFITS and FEATURES

- **Wide VIN Range: 3.9V to 29V (No Dead Zone)**
- **Supports 2 to 5 Cell Lithium-ion Batteries**
- **Supports OTG Function (5V ~ 22.5V Input) with wide range of output voltages**
- **OTG output supports QC3.0 / USB PD + PPS output levels and transition times**
- **Programmable Frequency: 125KHz, 250KHz, 500kHz, and 1MHz**
- **2V ~ 5.1V/100mA Programmable Output LDO**
- **Precision 0.5% Voltage Reference**
- **+/-4% Output Constant Current Regulation**
- **< 5 μ A Leakage Current from Battery in Shipping Mode**
- **Programmable Charge Voltage via I2C**
- **Programmable Charge Current via Pin and I2C**
- **Programmable Soft-Start**
- **Programmable Safety Timer**
- **Battery Path Impedance Compensation**
- **JEITA Compliant**
- **Cycle-by-Cycle Current Limit**
- **Built in ADC for Temperature, Input and Output Voltage and Current monitoring**
- **Thermal Regulation and Protection**
- **25m Ω FET from VIN to SW1**
- **25m Ω FET from SW2 to VOUT**
- **35m Ω FET from SW1 to PGND**
- **35m Ω FET from SW2 to PGND**
- **Low Output Ripple**
- **Thermally Enhanced 32-Lead 4mx4mm QFN**

APPLICATIONS

- Multi Cell Battery Charger
- Portable Battery-Powered Devices
- Car Charger
- Power Bank
- 24V Industrial Applications
- Automotive Power Systems
- Multiple Power Source Supplies
- DC UPS
- Solar Powered Devices
- Solid-State Lighting

GENERAL DESCRIPTION

The ACT286x is a buck-boost charger with 4 integrated MOSFETs. It offers a high efficiency, low component counts, compact solution for 2 to 5 cell battery charging application. It can operate from an input voltage range from 3.9V to 29V.

The 4 internal low resistance NMOS switches minimize the size of the application circuit and reduce power losses to maximize efficiency. Internal high side gate drivers, which require only the addition of two small external capacitors, further simplify the design process. An advanced switch control algorithm allows the buck-boost converter to maintain output voltage regulation with input voltages that are above, below or equal to the output voltage. Transitions between these operating modes are seamless and free of transients and subharmonic switching.

The ACT286x has been optimized to reduce input current in shipping, shutdown, and standby for applications which are sensitive to quiescent current draw, such as battery-powered devices.

Both the input side and output side voltages and currents can be configured by resistors or the I²C serial interface. The system can be monitored and configured by I²C as well. The build-in ADC can be read for the information of input/output voltages and currents, and the die temperature. With a MCU, it can easy to charge a multi cell battery pack from a variety of input power sources.

The IC provides various safety features for system operation. The thermal regulation reduces output current when the junction temperature exceeds 120°C (programmable).

The ACT286x is available in 32-pin, 4x4 mm QFN package.

FUNCTIONAL BLOCK DIAGRAM

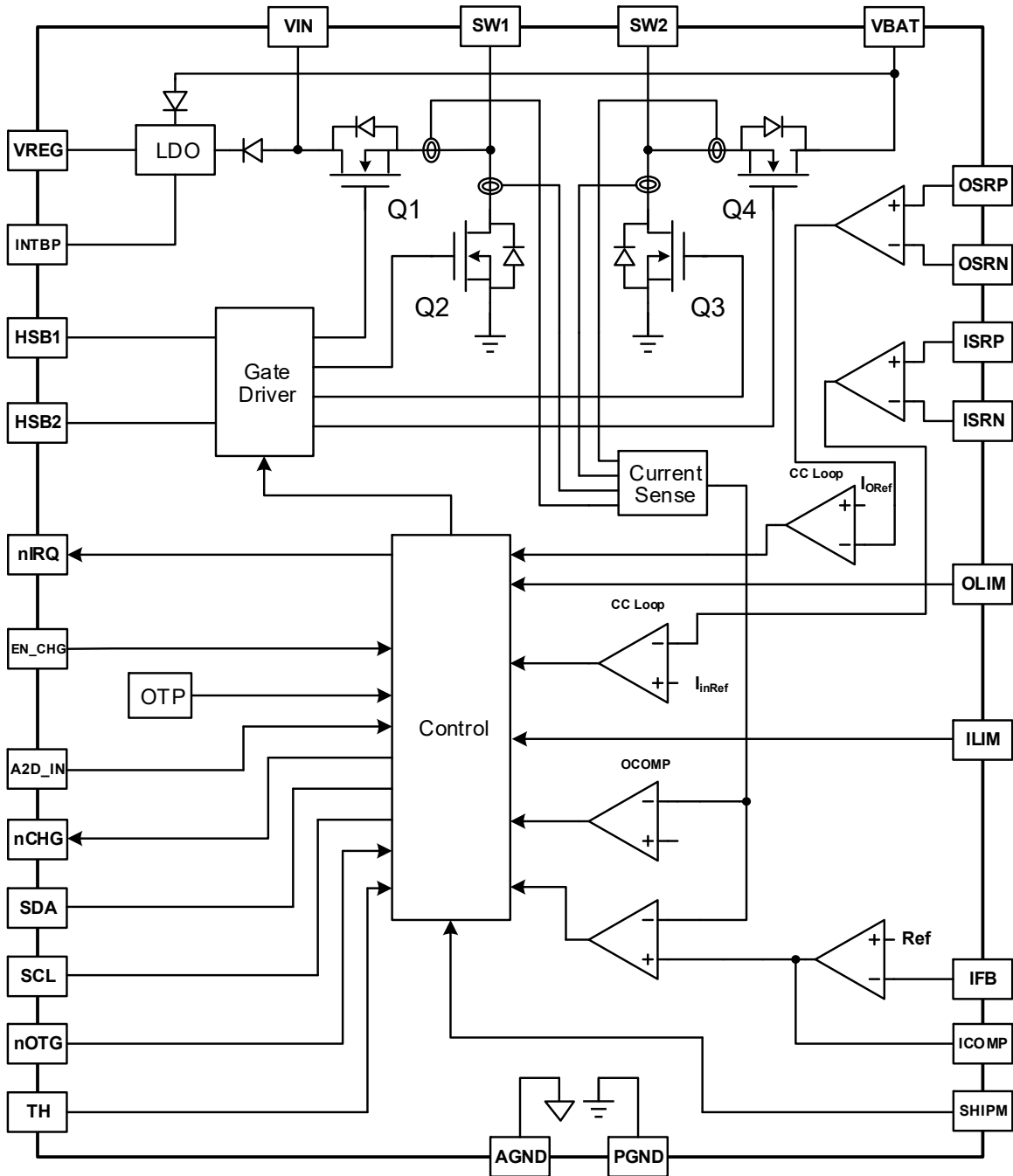

ORDERING INFORMATION

PART NUMBER	Cell Count	Termination Voltage	OTG Voltage	LDO	Fsw	JEITA	PACKAGE
ACT2861QI201-T	2	8.40V	5.1V	5.0V	500kHz	Enabled	FCQFN4x4-32
ACT2861QI301-T	3	12.6V	5.1V	5.0V	500kHz	Enabled	FCQFN4x4-32
ACT2861QI401-T	4	16.8V	5.1V	5.0V	500kHz	Enabled	FCQFN4x4-32

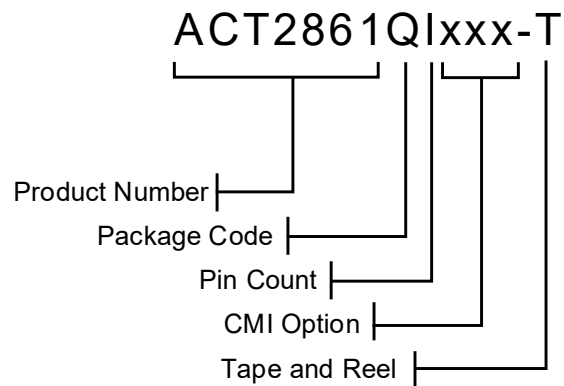

Note 1: Standard product options are identified in this table. Contact factory for custom options, minimum order quantity required.

Note 2: All Active-Semi components are RoHS Compliant and with Pb-free plating unless specified differently. The term Pb-free means semiconductor products that are in compliance with current RoHS (Restriction of Hazardous Substances) standards.

Note 3: Package Code designator "Q" represents QFN

Note 4: Pin Count designator "I" represents 32 pins

PIN CONFIGURATION

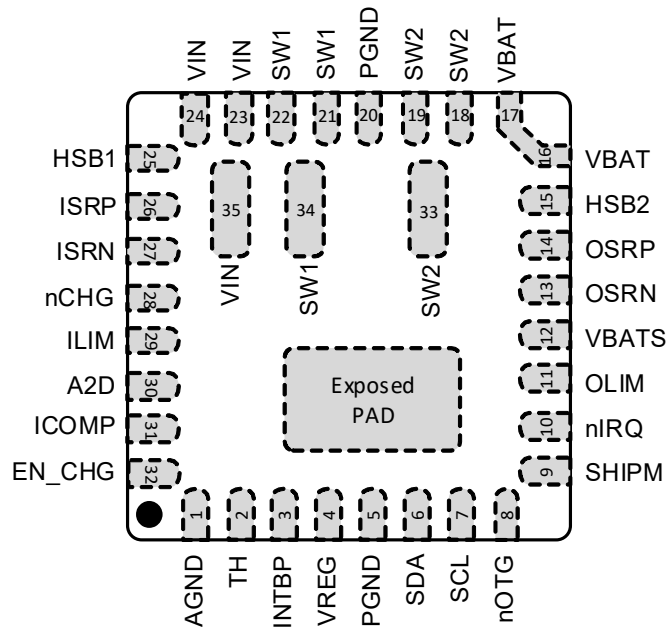

Figure 1: Pin Configuration – Top View – QFN4x4-32

PIN DESCRIPTIONS

PIN	NAME	DESCRIPTION
1	AGND	Analog Ground. Kelvin connect AGND to the PGND plane.
2	TH	Battery temperature sensing input. Connect a negative temperature coefficient thermistor from TH to AGND. This pin provides a constant current output and the voltage at this pin is used for temperature calculation. If temperature sensing is not used, leave TH open and set register bit "DIS_TH" to a 1
3	INTBP	Internal Voltage Bypass - Connect a 100nF ceramic capacitor between INTBP and AGND
4	VREG	Internal VREG LDO output. The output voltage is programmable from 2V to 5.1V. Connect a 1.0uF between VREG and AGND. The maximum current capability for this pin is 100mA.
5, 20	PGND	Power Ground. Connect to large ground plane on PCB with thermal vias.
6	SDA	I ² C Data Input and Output. Needs an external pull up resistor.
7	SCL	I ² C Clock Input. Needs an external pull up resistor.
8	nOTG	OTG Enable Input. The OTG mode is active when this pin is pulled low and the EN_OTG bit = 1. In OTG mode, the converter works in reverse operation mode, and power is transferred from battery to VIN.
9	SHIPM	Shipping Mode input. Shorting this pin to GND for 32ms enables the IC. If not used, connect SHIPM to AGND.
10	nIRQ	Interrupt Open-Drain Output. nIRQ goes low to indicate a fault condition. nIRQ is referenced to AGND.
11	OLIM	Output Fast charge current setting pin. Connect a resistor from OLIM to AGND to program the output current in normal charge mode.
12	VBATS	VBAT Sense Input – Kelvin connect close the battery to sense the battery voltage.
13	OSRN	Output current sense resistor negative input.
14	OSRP	Output current sense resistor positive input.
15	HSB2	High Side Bias Boot-strap pin. This provides power to the internal high-side MOSFET gate driver circuitry. Connect a 47nF capacitor from HSB2 to SW2 pin
16, 17	VBAT	Charging Power Output pin. Connect this pin to 22uF-100uF ceramic capacitors placed as close to the IC as possible.
18, 19, 33	SW2	Power switching output to external inductor.
21, 22, 34	SW1	Power switching output to external inductor.
23, 24, 35	VIN	Input voltage pin. Place a 22uF to 44uF decoupling capacitor between VIN and PGND.
25	HSB1	High Side Bias Boot-strap pin. This provides power to the internal high-side MOSFET gate driver circuitry. Connect a 47nF capacitor from HSB1 to SW1 pin
26	ISRP	Input current sense resistor positive input.
27	ISRN	Input current sense resistor negative input
28	nCHG	Open drain charge status indicator. nCHG = L indicates charging is in progress. nCHG = HIZ indicates charge complete or charger disabled. nCHG = H to L at 1Hz indicates a fault condition.
29	ILIM	Input current limit and OTG output current setting pin. Connect a resistor from ILIM to AGND to program the input current when operating in normal mode and to program the output current when operating in OTG Mode.

30	A2D	A2D input pin
31	ICOMP/GPIO	OTG mode Error Amplifier Output. This pin is used to compensate the converter when operating in OTG mode.
32	EN_CHG	Charge Enable pin. Charging is enabled when EN_CHG is above 0.8V. Connect a resistor divider to EN_CHG to program charging input UVLO.
Exposed Pad	PGND	Power Ground. Connect to large ground plane on PCB with thermal vias.

ABSOLUTE MAXIMUM RATINGS

PARAMETER	VALUE	UNIT
VIN	-0.3 to +31	V
ISRP, ISRN	-0.3 to VIN + 0.3	V
VBAT	-0.3 to +23	V
OSRP, OSRN	-0.3 to VBAT + 0.3	V
VBATS	-0.3 to OSRN + 0.3	V
SW1	-0.3 to VIN + 0.3	V
SW2	-0.3 to VBAT + 0.3	V
HSB1	V _{SW1} - 0.3 to V _{SW1} + 5.5	V
HSB2	V _{SW2} - 0.3 to V _{SW2} + 5.5	V
SCL, SDA, VREG, nCHG, EN_CHG, nOTG, TH, nIRQ, ICOMP, ILIM, OLIM, SHIPM, A2D	-0.3 to +6	V
AGND to PGND	-0.3 to +0.3	V
Junction to Ambient Thermal Resistance (θ_{JA})	35	°C/W
Operating Junction Temperature (T_J)	-40 to 150	°C
Operating Ambient Temperature Range (T_A)	-40 to 85	°C
Store Temperature	-55 to 150	°C
Lead Temperature (Soldering, 10 sec)	300	°C

Note1: Measured on Active-Semi Evaluation Kit

Note2: Do not exceed these limits to prevent damage to the IC. Exposure to absolute maximum rating conditions for long periods may affect IC reliability.

SYSTEM CHARACTERISTICS

(VIN = 12V, VBAT = 7.6V, TA = 25°C, unless otherwise specified)

PARAMETER	SYMBOL	CONDITIONS	MIN	TYP	MAX	UNIT
Input Voltage						
Input voltage Range	V _{IN}		4		29	V
Input Over Voltage Protection	V _{IN_OVP}	Rising Measured at VIN Pin	29	30	31	V
Input Over Voltage Hysteresis				2		V
Input Over Voltage Response Time	T _{VIN_OVP}	VIN step from 20V to 31V		250		ns
VIN UVLO Threshold	V _{IN_UVLO}	VIN Rising Measured at VIN Pin	3.725	3.9	4.075	V
VIN UVLO Hysteresis	V _{IN_UVLO_HYST}	VIN Falling Measured at VIN Pin		200		mV
EN_CHG INPUT Threshold	V _{EN_IN}	EN_CHG Rising	0.7	0.8	0.9	V
EN_CHG INPUT Hysteresis	V _{EN_IN_HYST}	EN_CHG Falling		160		mV
CURRENT REGULATION - VIN INPUT AND CURRENT REGULATION IN CHARGE MODE						
Input Voltage Regulation Accuracy	V _{INLIM_REG_ACC}	Measured from VIN Pin to AGND Pin Relative to the factory default Register Setting	-2	V _{INLIM}	+2	%
Input Current Regulation Range	I _{INLIM_RANGE}	With I _{IN_LIM} =100% register setting	0.5		5	A
Input Current Regulation Accuracy	I _{IN_ILIM}	I _{IN_LIM} = 0.5A to 1A R _{sense} = 0.01Ohms	-20	I _{IN_ILIM}	+20	%
	I _{IN_ILIM}	I _{IN_LIM} = 1A to 2A R _{sense} = 0.01Ohms	-15	I _{IN_ILIM}	+15	%
	I _{IN_ILIM}	I _{IN_LIM} > 2A R _{sense} = 0.01Ohms	-10	I _{IN_ILIM}	+10	%
VIN INPUT QUIESCENT CURRENTS						
Input Supply Current HIZ	I _{IN_HIZ1}	VIN=12V, VBAT=8.4V, EN Low, converter off, I2C on, VREG is OFF		35		μA
	I _{IN_HIZ2}	VIN=12V, VBAT=8.4V, EN Low, converter off, I2C on, VREG is ON		50		μA
	I _{IN_HIZ3}	VIN=12V, VBAT=8.4V, EN Low, converter off, I2C on, VREG is on, A2D Enabled, Fault Monitor Enabled, TH Enabled		1000		μA
Input Supply Current at No Load	I _{IN_NOLOAD}	VIN=5V, Charger Mode, converter switching, I2C on, VREG on, no load, 500kHz		1		mA
VBAT INPUT QUIESCENT CURRENTS						

Battery Current Ship Mode	I _{BAT_SHIP}	VBAT = 8.4V, no VIN, Shipping mode, Converter off, I2C off, VREG off, SHIPM Pin Enabled		1	2.5	μA
Battery Current in HIZ	I _{BAT_HIZ1}	VBAT=8.4V, VIN < VBAT, Converter off, I2C on, VREG off		20		μA
	I _{BAT_HIZ2}	VBAT=8.4V, VIN < VBAT, Converter off, I2C on, VREG on		35		μA
	I _{BAT_HIZ3}	VBAT=8.4V, VIN < VBAT, Converter off, I2C on, VREG on, A2D Enabled, Fault Monitor Enabled, TH Enabled		1100		μA
Battery Current OTG	I _{BAT_OTG}	VBAT=8.4V, V _{OTG_OUT} =5V		1		mA
INTERNAL MOSFETS						
VIN to SW1 FET Resistance	R _{DSONQ1}	T _J = 25C		25		mΩ
SW1 to PGND FET Resistance	R _{DSONQ2}	T _J = 25C		35		mΩ
SW2 to PGND FET Resistance	R _{DSONQ3}	T _J = 25C		35		mΩ
VBAT to SW2 FET Resistance	R _{DSONQ4}	T _J = 25C		25		mΩ
Cycle By Cycle Current Limit	I _{FET_ILIM}	FET_ILIM=0 Q1, Q2, Q3, or Q4 in any mode	6.5	8.5	10.5	A
		FET_ILIM=1 Q1, Q2, Q3, or Q4 in any mode	7.75	10	12.25	A

BATTERY CHARGER

(VIN = 12V, VBAT = 7.6V, TA = 25°C, unless otherwise specified)

PARAMETER	SYMBOL	CONDITIONS	MIN	TYP	MAX	UNIT
Battery Regulation Voltage Accuracy	V _{BAT_REG_ACC}	V _{BAT} = V _{BAT} Register Setting Measured at VBATS Pin	-0.5		0.5	%
Fast Charge Current Range	I _{FCHG_REG_RANGE}	With I _{CHG} =100% register setting	0.5		5	A
Fast Charge Current Regulation Accuracy (10mΩ current sensing resistor)	I _{FCHG_REG_ACC}	V _{BAT} = V _{BAT_LOW} , I _{CHG} =2A	-5		+5	%
		V _{BAT} = V _{BAT_LOW} , I _{CHG} =1A	-10		+10	%
		V _{BAT} = V _{BAT_LOW} I _{CHG} =500mA	-20		+20	%
Pre-charge Current Regulation Accuracy (10mΩ current sensing resistor)	I _{PRECHG_ACC}	V _{BAT} = V _{BAT_LOW} , I _{CHG} =250mA	-30		+30	%
		V _{BAT} = V _{BAT_LOW} , I _{CHG} =125mA	-40		+40	%
Termination Voltage Accuracy (default factory setting)	V _{TERM_ACC}	V _{BATSHORT} <V _{BAT} <V _{BAT_LOW} I _{TERM} = 250mA	-30		+30	%
Battery Short Charge Current (default factory setting for I _{SHRT} and V _{BATSHORT})	I _{SHRT}	V _{BATSHORT} <V _{BAT} <V _{BAT_LOW} I _{SHRT} =200mA	120	200	280	mA
		V _{BAT} < V _{BATSHORT} -100mV V _{BAT} > 3V I _{SHRT} =400mA	300	400	400	mA
Minimum Battery Voltage for Active I ² C	V _{BAT_UVLOZ}	V _{BAT} rising Measured at VBATS Pin	3.75	3.9	4.15	V
Battery LOW Threshold	V _{BAT_LOW}	Pre-Charge to Fast Charge with V _{BAT} Rising Relative to the factory default V _{BAT_LOW} Register Setting Measured at VBATS Pin	-3.3	V _{BAT_LOW}	+ 3.3	%
Battery LOW Hysteresis	V _{BAT_LOW_HYST}	Fast Charge to Pre-Charge with V _{BAT} Falling Relative to the factory default V _{BAT_LOW} Register Setting Referenced to actual V _{BAT_LOW} measurement Measured at VBATS Pin	3.3	6	8.6	%
Battery Short Voltage	V _{BATSHORT}	BAT Short Charge level to Pre- Charge level with V _{BAT} rising Relative to the factory default V _{BATSHORT} Register Setting Measured at VBATS Pin	-2.5	V _{BATSHORT} T	+ 2.5	%
Battery Short Voltage Hysteresis	V _{BATSHORT_HYST}	BAT Pre-Charge to Short Charge level with V _{BAT} Falling Relative to the actual V _{BATSHORT} measurement Measured at VBATS Pin	4	5	6	%

Battery Good Voltage	V _{BATGOOD}	V _{BAT} Rising Relative to the factory default V _{BATGOOD} Register Setting Measured at VBATS Pin	-3%	V _{BAT_GOOD}	+3%	%
Battery Good Voltage Hysteresis	V _{BATGOOD_HYST}	V _{BAT} falling Relative to the actual V _{BATGOOD} measurement Measured at VBATS Pin	3	4	5	%
Battery SHORT to Precharge and Pre-Charge to Short De- glitch Time	t _{VBATSHORT}	Battery voltage rising and falling at V _{BATSHORT} threshold		16		ms
Battery Pre-Charge to Fast Charge and Fast Charge to Pre- Charge deglitch time	t _{VBAT_LOW}	Battery voltage rising and falling at V _{BAT_LOW} threshold		16		ms
Battery Charge Termination Cur- rent detection delay	t _{VBATTERM}	Termination current below and above I _{TERM} threshold		750		ms
Battery Good Detection deglitch Time	t _{VBATGOOD}	Battery voltage rising and falling at V _{BATGOOD} threshold		16		ms
Battery Path Compensation	R _{BAT_COMP}	I _{CHG} = 1A At default programmed setting for R _{VBAT_PATH_COMP}	-20	R _{VBAT_PA TH_COMP}	+20	%
		I _{CHG} = 2A At default programmed setting for R _{VBAT_PATH_COMP}	-15	R _{VBAT_PA TH_COMP}	+15	%
		I _{CHG} = 3A At default programmed setting for R _{VBAT_PATH_COMP}	-10	R _{VBAT_PA TH_COMP}	+10	%
Battery Path Compensation Voltage Clamp	V _{BAT_COMP_CLAMP}	Enable Measured at VBATS Pin	-20	V _{BAT_COM P_CLAMP}	+20	mV
Dead Battery Voltage	V _{DBATTERY}	Measured at VBATS Pin	2.8	3	3.2	V
Dead Battery Hysteresis	V _{DBATTERY_HYST}	Measured at VBATS Pin		100		mV
Dead Battery Current	I _{DBATTERY}	Charge Current from V _{BAT} pin	5	10	20	mA
BATTERY OVER-VOLTAGE PROTECTION						
Battery over-voltage threshold	V _{BATOVP}	V _{BAT} rising, as percentage of V _{BAT_REG} Measured at VBATS Pin	102	104	106	%
Battery over-voltage hysteresis	V _{BATOVP_HYST}	V _{BAT} falling, as percentage of V _{BAT_REG} Measured at VBATS Pin		2		%
Battery over-voltage deglitch time to disable charge	t _{BATOVP}	VBAT_OV_DEGLITCH_EN Register =0		5		us
		VBAT_OV_DEGLITCH_EN Register =1		40		msec
PWM OPERATION						
Programmable Frequency Range	F _{SW}		125		1000	kHz

Operation Frequency Accuracy	F_{SW}		-10		+10	%
Maximum PWM Duty Cycle	D_{MAX}			97		%

LDO

($V_{IN} = 12V$, $V_{BAT} = 7.6V$, $T_A = 25^\circ C$, unless otherwise specified)

PARAMETER	SYMBOL	CONDITIONS	MIN	TYP	MAX	UNIT
Normal Mode						
VREG Regulation Voltage	VREG		2		5.1	V
VREG Regulation Accuracy	VREG _{ACC}	At Default Factory Setting	-2		2	%
VREG Dropout	VREG _{DROPOUT}	$I_{OUT} = 100mA$			300	mV
VREG UVLO Threshold	VREG _{UVLO}	VREG Falling	84	88	93	%
VREG UVLO Hysteresis	VREG _{UVLO_HYST}			2		%
VREG Current Limit	VREG _{ILIM}	$V_{VIN} = 12V$, $V_{REG} = 5V$	100	175	250	mA
VREG Current Limit Deglitch	VREG _{ILIM_DG}	In current limit		50		us
VREG Current Limit Off Time	VREG _{ILIM_OFF}	After Deglitch Time		100		ms
VREG Soft Start	VREG _{SS}			250		us

OTG

(VIN = 12V, VBAT = 7.6V, TA = 25°C, unless otherwise specified)

PARAMETER	SYMBOL	CONDITIONS	MIN	TYP	MAX	UNIT
OTG Output Voltage	V _{OTG_REG_ACC}	Internal Feedback Mode VOTG_I2C Register = 0 Relative to the factory default setting. OTG output in PWM Mode. Measured at VIN Pin	-1		1	%
OTG Reference Voltage	V _{OTG_REF_ACC}	External Feedback VOTG_I2C Register = 1	1.99	2	2.01	V
OTG Battery Cut Off Voltage	V _{OTG_BAT_CUTOFF}	VBAT Rising Relative to the factory default VOTG_VBAT_CUTOFF Register setting Measured at VBATS Pin	-3.0	V _{OTG_VBAT_CUTOFF}	3.0	%
OTG Battery Cut Off Voltage Hysteresis	V _{OTG_BAT_CUTOFF_HSYT}	VBAT Falling Relative to the actual VOTG_VBAT_CUTOFF voltage Measured at VBATS Pin	3	4	5	%
OTG Battery OV Threshold	V _{OTG_BAT_OV}	VBAT Rising Measured at VBATS Pin	22.75	23.5	24.25	V
OTG Battery OV Hysteresis	V _{OTG_BAT_OV_HYST}	VBAT Falling Measured at VBATS Pin		300		mV
OTG Output Current Range	I _{OTG_RANGE}	With I _{CHG} = 100% register setting	0.5		5	A
OTG Mode Output Constant Current (measured at ISRN and ISRP pins using 10mΩ current sensing resistor)	I _{OTG_OCP}	I _{OTG_OCP} = 0.5A to 1A	-20	I _{OTG}	+20	%
		I _{OTG_OCP} = 1A to 2A	-15	I _{OTG}	+15	%
		I _{OTG_OCP} > 2A	-10	I _{OTG}	+10	%
OTG Mode Output Constant Current Undervoltage Protection Threshold	V _{OTG_UVP}	V _{OTG} Falling Enters Hiccup Mode Measured at VIN pin	2.62	2.72	2.82	V
OTG Mode Output Constant Current Undervoltage Protection Deglitch Time	t _{OTG_UVP}	V _{OTG} Falling		7		us
OTG Hiccup Mode Off-Time	t _{OTC_HICCUP}	Off-time after V _{OTG} falls below V _{OTG_UVP}		3		secs
OTG Overvoltage Threshold	V _{OTG_OVP_INT}	Reference to OTG_VOUT Register Setting Measured at VIN Pin	105	108	111	%
OTG Overvoltage Threshold Hysteresis	V _{OTG_OVP_HYS}	Falling Threshold		2		%
OTG Soft Start Time	t _{OTG_SS}	Relative to the factory default OTG_SS Register Setting. From 0 to 100%	-30	OTG_SS Setting	30	%
OTG Pulldown Current Source	I _{OTG_PD}	V _{OTG} Output > 2.0V	30	65	120	mA
OTG Off-Delay Timer	t _{OTG_OFF_DLY}	OFF DLY is enabled	-10	OTG_OFF_DLY	+10	%

				Setting		
OTG Off-Delay Current	I _{OTG_OFF_LOAD}	OTG in Buck Mode Only and OTG Output less than 6V V _{BAT} > V _{OTG} + 0.5V	3	4	6	mA
OTG Cord Compensation Accuracy	V _{OTG_CC}	OTG Cord Compensation Enabled OTG_CORD_COMP: 00: Disabled 01: 100mV 10: 200mV 11: 300mV Measured at VIN Pin	-15	OTG_CORD_COMP Setting	+15	%
OTG Output Slew Accuracy	I _{OTG_SLEW}	OTG Output Slew Setting OTG_OUTPUT_SLEW 00: 1.0V/ms 01: 0.5V/ms 10: 0.3V/ms 11: 0.1V/ms Internal Feedback Only VOTG_I2C Register = 0	-20	OTG_OUTPUT_SLEW Setting	+20	%
OTG Battery ILIM	I _{OTG_BAT}	I _{OTG_BAT} = 0.5A to 1A	-20	I _{OTG_BAT}	+20	%
		I _{OTG_BAT} = 1A to 2A	-15	I _{OTG_BAT}	+15	%
		I _{OTG_BAT} > 2A	-10	I _{OTG_BAT}	+10	%

THERMAL PROTECTION

(VIN = 12V, V_{BAT} = 7.6V, T_A = 25°C, unless otherwise specified.)

PARAMETER	SYMBOL	CONDITIONS	MIN	TYP	MAX	UNIT
Thermal Regulation and Shutdown						
Charger Mode Junction Temperature Regulation Accuracy	T _{REG}	00: Disabled 01: 80 °C 10: 100 °C 11: 120 °C	-20	T _{REG}	+20	°C
Thermal Shutdown Rising Temperature	T _{SHUT}	Temperature Increasing		160		°C
Thermal Shutdown Hysteresis	T _{SHUT_HYS}			30		°C
Thermal Shutdown Deglitch		Enter or Exit Thermal Shutdown		32		us
NTC Thermistor Input						
NTC TH Current Source	I _{TH}	When TH Pin Enabled	64.8	67.5	70.2	uA
NTC TH Current Source Leakage	I _{TH_DISABLE}	When TH Pin Disable			1	uA
NTC TH -10°C Voltage	V _{TH-10C}		2.770	2.870	2.970	V
NTC TH 0°C Voltage	V _{TH0C}		1.780	1.840	1.900	V
NTC TH 10°C Voltage	V _{TH10C}		1.165	1.21	1.255	V
NTC TH 45°C Voltage	V _{TH45C}		0.317	0.332	0.347	V

NTC TH 55°C Voltage	V_{TH55C}		0.223	0.238	0.253	V
NTC TH 60°C Voltage	V_{TH60C}		0.188	0.203	0.218	V
NTC TH 65°C Voltage	V_{TH65C}		0.160	0.175	0.190	V
Deglitch time for each range transition				16		ms
TH Detect Battery or Very Cold Temp Threshold	$V_{TH_NO_BAT}$	When TH Pin Enabled		INTBP -150		mV
TH Detect Battery or Very Cold Temp Threshold Hysteresis	$V_{TH_NO_BAT_HYST}$	When TH Pin Enabled		50		mV

ADC CONVERTER

(VIN = 12V, VBAT = 7.6V, TA = 25°C, unless otherwise specified.)

PARAMETER	SYMBOL	CONDITIONS	MIN	TYP	MAX	UNIT
Total Error	A2D _{ERROR}	12 Bit Range			0.5	LSB
Conversion Time	A2D _{ICONV}	All 6 Channels			100	ms
Conversion Time	A2D _{ICONV}	1 Channel			15	ms
Input Capacitance	A2D _{CIN}			5		pF
A2D Full Scale Input EXT_IN	A2D _{FS}			2.5		V
A2D Full Scale VIN	A2D _{VIN}	Measurement input at VIN pin	0		32.5	V
A2D Full Scale VBAT	A2D _{VBAT}	Measurement input at VBATS Pin	1.5		25	V
A2D Full Scale OLIM, ILIM	A2D _{OLIM} , A2D _{ILIM}			2.5		V
A2D Full Scale TH	A2D _{TH}	Battery NTC Voltage			3.5	V

SHIP MODE

(VIN = 12V, VBAT = 7.6V, TA = 25°C, unless otherwise specified.)

PARAMETER	SYMBOL	CONDITIONS	MIN	TYP	MAX	UNIT
SHIPM Deglitch Time Exit	t _{SHIPM_EXIT}	Ship Mode Enabled From SHIPM pin or VIN threshold	12	32	60	ms
SHIPM Pullup Resistor Exit	R _{SHIPM_PU}	Ship Mode Enabled	1	1.35	2	MΩ
SHIPM Pullup Voltage Exit	V _{SHIPM_PU}	Ship Mode Enabled		3		V
SHIPM Input low threshold Exit	V _{SHIPM_L}	Ship Mode Enabled	1.5			V
SHIPM Input Hysteresis Exit	V _{SHIPM_HYST}	Ship Mode Enabled	100			mV
SHIPM VIN Threshold Exit	V _{SHIP_VIN}	Ship Mode Enabled		3.9		V
SHIPM Pull Down Resistor	R _{SHIPM_PD}	Ship Mode Disabled	0.7	1	1.3	MΩ
SHIPM Enter Voltage to Re-enter Ship Mode	V _{SHIP_ENTER}	Voltage on SHIPM Pin Ship Mode Disabled		4.5		V
SHIPM Deglitch Time to Re-enter Ship Mode	t _{SHIPM_ENTER}	Ship Mode Disabled	20	32	45	ms
SHIPM Delay entering Ship Mode using I ² C Register Bit	t _{SHIPM_ENTER_I2C}	Ship Mode Disabled	0.8	1	1.2	s

LOGIC PIN CHARACTERISTICS – NOTG, NCHG, NIRQ, GPIO

(VIN = 12V, VBAT = 7.6V, TA = 25°C, unless otherwise specified.)

PARAMETER	SYMBOL	CONDITIONS	MIN	TYP	MAX	UNIT
nOTG, GPIO Input low threshold	V _{ILO}				0.4	V
nOTG, GPIO Input high threshold	V _{IHI}		1.25			V
nCHG, nIRQ, GPIO Output Low Voltage	V _{OL}	Sink Current = 5 mA			0.4	V
nCHG, nIRQ, GPIO High Level Leakage Current	I _{OH}	Output = 5V			1	uA

I²C INTERFACE ELECTRICAL CHARACTERISTICS

(VIN = 12V, VBAT = 7.6V, TA = 25°C, unless otherwise specified.)

PARAMETER	SYMBOL	CONDITIONS	MIN	TYP	MAX	UNIT							
SCL, SDA Input Low	V _{ILO}	V _{IO} = 1.8V			0.4	V							
SCL, SDA Input High	V _{IHI}	V _{IO} = 1.8V	1.25			V							
SDA Leakage Current	I _{OH}	SDA = 5V			1	μA							
SDA Output Low	V _{OL}	I _{OL} = 5mA			0.4	V							
SCL Clock Frequency	f _{SCL}		0		1000	kHz							
SCL Low Period	t _{SCL_LOW}		0.5			us							
SCL High Period	t _{SCL_HI}		0.26			us							
SDA Data Setup Time	t _{SU}		50			ns							
SDA Data Hold Time	t _{HD}		0			ns							
Start Setup Time	t _{ST}		260			ns							
Stop Setup Time	t _{SP}		260			ns							
Capacitance on SCL or SDA PIN	C _{IN}				10	pF							
Noise suppression on SCL and SDA	t _{DEGLITCH}				50	ns	I ² C Timeout Function	t _{out}	Total time required for I ² C communication to cause I ² C state machine to reset		100		ms
I ² C Timeout Function	t _{out}	Total time required for I ² C communication to cause I ² C state machine to reset		100		ms							

Note1: Comply with I²C timings for 1MHz operation - "Fast Mode Plus".

Note2: No internal timeout for I²C operations, however, I²C communication state machine will be reset when entering UV/POR State.

Note3: This is an I²C system specification only. Rise and fall time of SCL & SDA not controlled by the IC.

Note4: IC Address is factory configurable to 7'h24, 7'h66.

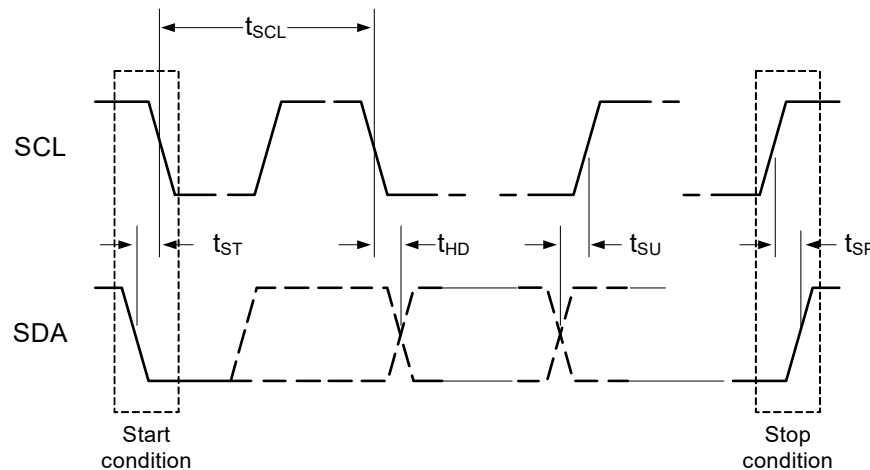

Figure 2: I²C Data Transfer

FUNCTIONAL DESCRIPTION

General

ACT2861 is a buck-boost charger with integrated MOSFETs. It provides a high efficiency, low external component count, minimal size solution for 2 to 5 cell battery charging applications. Its wide input operating range of 4V to 29V allows charging from many input sources.

The ACT2861 also operates in OTG (On-The-Go) mode where it operates in reverse operation by converting the battery voltage to a regulated output voltage on the VIN pin. It autonomously switches between buck, buck-boost, and boost modes depending on the input and output voltages. It is optimized for minimum quiescent current in shipping, shutdown, and standby modes. This makes it ideal for battery powered applications. SHIP mode reduces the total quiescent current to 1uA. It automatically resumes normal operation when the SHIPM pin is pulled low or power is applied to VIN.

The ACT2861 can be operated in both stand-alone and host-controlled applications. External resistors set the fast charge current, input current limit, and OTG current limit. Using host controlled I²C operation, the user has full control over voltage, current, and fault settings. The IC can be configured to charge any battery chemistry.

I²C operation gives the host full control of operating parameters as well as full knowledge of the operating parameters and fault conditions. A built in ADC provides input voltage, output voltage, input current, output current, and die temperature. The ADC also has one general purpose input to measure an external analog signal.

The ACT2861 is highly flexible and contains many I²C configurable functions. The IC's default functionality is defined by its default CMI (Code Matrix Index), but much of this functionality can be changed via I²C. I²C functionality includes OV and UV fault thresholds, switching frequencies, current limits, precharge and fast charge current settings, charging termination voltage, JEITA settings, and more. The CMI Options section shows the default settings for each available CMI option. Contact sales@active-semi.com for additional information about other configurations.

I²C Serial Interface

To ensure compatibility with a wide range of systems, the ACT2861 uses standard I²C commands. It supports clock speeds up to 1MHz. The ACT2861 always operates as a slave device, and can be factory configured to one of two 7-bit slave addresses. The 7-bit slave address is followed by an eighth bit, which indicates whether the transaction is a read-operation or a write-

operation. Refer to each specific CMI for the IC's slave address

Table 1: ACT2861 I²C Addresses

7-Bit Slave Address		8-Bit Write Address	8-Bit Read Address
0x24h	010 0100b	0x48h	0x49h
0x66h	110 0110b	0xCCh	0xCDh

The I²C packet processing state machine has a 100ms timeout function for each I²C command. If there is greater than 100ms between a start bit and a stop bit, the ACT2861 resets the I²C packet processing and sets the I²C_FAULT bit in register 0x06h. Any time the I²C state machine receives a start bit command, it immediately resets the packet processing, even if it is in the middle of a valid packet. The I²C functionality is operational in all states except RESET.

I²C commands are communicated using the SCL and SDA pins. SCL is the I²C serial clock input. SDA is the data input and output. SDA is open drain and must have a pull-up resistor. Signals on these pins must meet timing requirements in the Electrical Characteristics. For more information regarding the I²C 2-wire serial interface, refer to the NXP website: <http://www.nxp.com>.

I²C Registers

The ACT2861 has an array of internal registers that contain the IC's basic instructions for setting up the IC configuration, output voltages, switching frequency, fault thresholds, fault masks, etc. These registers give the IC its operating flexibility. The two types of registers are described below.

Basic Volatile – These are R/W (Read and Write) and RO (Read only). After the IC is powered, the user can modify the R/W register values to change IC functionality. Changes in functionality include things like masking certain faults. The RO registers communicate IC status such as fault conditions. Any changes to these registers are lost when power is recycled. The default values are fixed and cannot be changed by the factory or the end user.

Basic Non-Volatile – These are R/W and RO. After the IC is powered, the user can modify the R/W register values to change IC functionality. Changes in functionality include things like output voltage settings, startup delay time, and current limit thresholds. Any changes to these registers are lost when power is recycled. The default values can be modified at the factory to optimize IC functionality for specific applications. Please consult

sales@active-semi.com for custom options and minimum order quantities.

When modifying only certain bits within a register, take care to not inadvertently change other bits. Inadvertently changing register contents can lead to unexpected IC behavior.

STATE MACHINE

ACT2861 contains an internal state machine with four internal states: SHIP MODE, HIZ, OTG MODE, and CHARGE MODE.

SHIP MODE State

SHIP MODE is the IC's lowest power state. The ACT2861 always starts up in SHIP MODE. This mode is designed to reduce battery current during shipping. In this state, the IC is completely disabled except for the SHIPM pin and the input voltage detection circuitry. This results in 1uA of quiescent current from the battery. The IC can enter SHIP MODE via I²C, the SHIPM pin, or after a full power down of both input and battery voltage. See the SHIP MODE section for more details.

HIZ State

HIZ mode is a low power state with the switching converter disabled. In this mode, I²C is active and the IC configuration can be changed. The IC enters HIZ from SHIP MODE and then either stays in HIZ or transitions to OTG MODE or CHARGE MODE depending on the external voltages, the EN_CHG pin, and the nOTG pin settings. Note that the HIZ Register overrides the EN_CHG and nOTG pin settings and holds the IC in HIZ mode. See the HIZ section for more details.

CHARGE MODE

In CHARGE MODE, the ACT2861 transfers power from VIN to VBAT to charge the battery. The IC follows the Charge State Machine. While in CHARGE MODE, the nOTG pin is ignored until charge mode is disabled. See the CHARGE MODE section for more details.

OTG MODE

In OTG MODE, the ACT2861 transfers power from VBAT to VIN to provide a regulated supply from the battery. The IC enters this mode with the nOTG Pin or the OTG_EN_OVERRIDE register. Once in OTG Mode, the IC follows the OTG State Machine. While in OTG MODE, the EN_CHG input is ignored. See the OTG MODE section for more details.

CHARGE STATE MACHINE

When the ACT2861 is in CHARGE MODE, it follows a dedicated charging state machine that autonomously handles complete battery charge control. This state machine is pre-configured for Li-Ion batteries. The ACT2861 can be configured to charge any battery topology using I²C.

Reset State (RESET)

All charging starts in the RESET State. In this state, all charging is completely disabled. The IC waits until the VIN voltage is within specification and then starts the Startup Delay timer. This timer is controlled by I²C bits VIN_STRT_DLY[1:0] in register 0x0Dh.

During this state the nCHG pin is pulled low to indicate charging is in progress.

The Low Battery Safety timer and the Fast Charge Safety Timer are both held in reset in this state.

Dead Battery Condition State (SCOND_DB)

This charging state protects against dead batteries or battery packs where the internal battery FET has opened. The ACT2861 always enters this state after a valid input voltage is applied and the Startup Delay timer is expired. If the total battery voltage is less than 3V, the IC stays in this state and sources 10mA to the battery. In many cases, the internal battery FET is opened and the 10mA source current will reset the battery FET. The IC exits this state when the battery voltage increases above 3V for > 256us. The Low Battery Safety Timer runs in this mode.

During this state the nCHG pin is pulled low to indicate charging is in progress.

Battery Short Condition State (SCOND)

This state also protects against dead batteries. It provides a reduced charge current to protect over-discharged batteries. The default charging current is 100mA, but this can be modified via I²C bits VBAT_SHORT_CURRENT in register 0x0Bh.

During normal charging, the charger enters SCOND when the battery voltage is greater than 3V for 16ms.

The system continuously monitors the battery voltage and if the battery voltage is greater than the VBATSHORT voltage threshold for 16ms, the charger exits the SCOND state and moves to the Precondition state. The battery short detection voltage, VBAT_SHORT, is adjustable by I²C bits VBAT_SHORT in register 0x0Bh. Note: If the battery

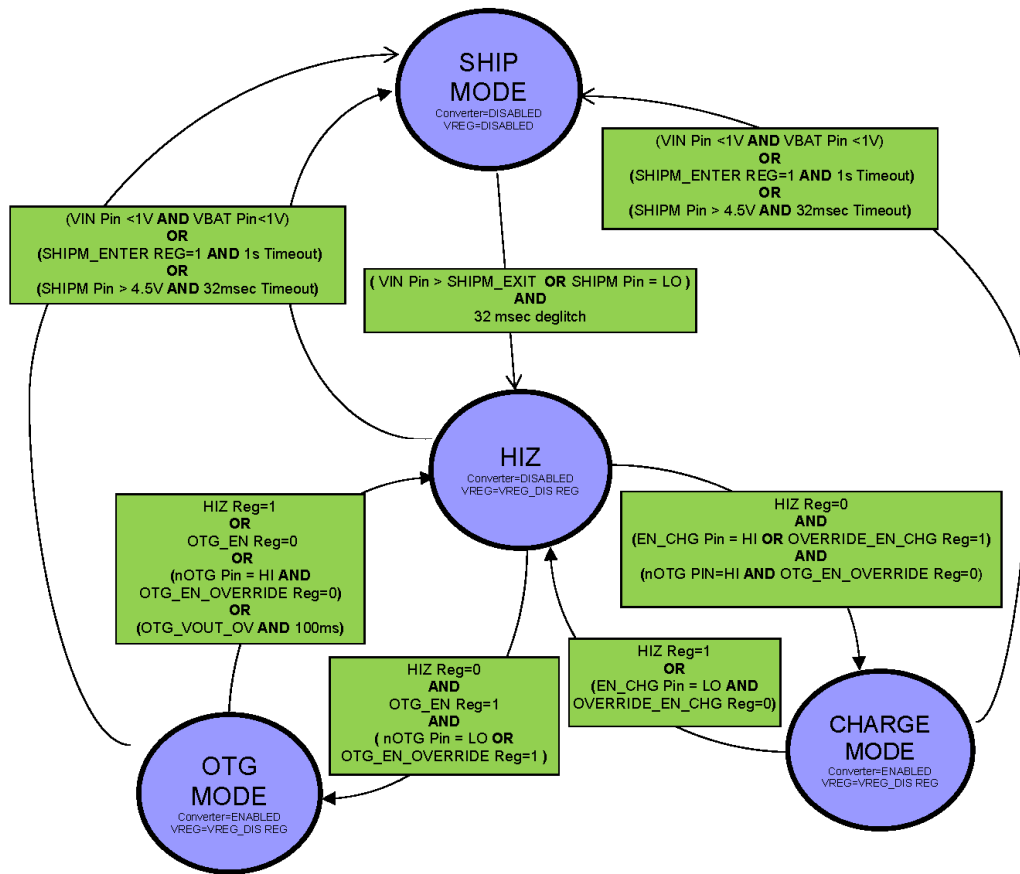

Figure 3: Operating Modes State Machine

voltage is above the VBATSHORT voltage when entering this state, the charger still charges at the ISHRT current for 16ms before moving to the Precondition state.

During this state, the Low Battery Safety Timer is running to detect fault conditions or bad battery. See the Charge Safety Timers section for further details. The Low Battery Safety Timer is a cumulative timer for the SCOND, and PCOND states and is fixed at 2 hours.

A Safety Timer timeout or Battery OV during this state causes the charger to move to the Fault State, which disables charging. An input voltage OV or UV condition also moves the state machine into the Fault state. Finally, a fault on the VREG LDO, which is not masked with the DIS_CHG_VREG_FLT register also moves the state machine into the Fault state.

During this state, the VIN voltage and VIN Current regulation loops are active to ensure the input supply power ratings are not exceeded. Additionally, the thermal regulation loop is active to keep the ACT2861 junction temperature at or below the desired maximum junction temperature. See the appropriate sections for more details.

During this state the nCHG pin is pulled low to indicate charging is in progress.

Battery Short Condition Temp Suspend (SCSUSPEND)

This state prevents charging when the battery temperature measured by the TH pin exceeds the JEITA or Battery Temp registers settings for Hot or Cold. All switching stops and charging is suspended. The state machine only enters SCSUSPEND from the SCOND state. The charger transitions back to the SCOND state and

resumes charging when the temperature returns to allowable levels. The system can force the IC out of the SCSUSPEND state by disabling the TH input via I²C.

In this state, the Low Battery Safety Timer is suspended, but held at its current value, in SCSUSPEND state. The timer resumes counting when charging resumes.

During this state the nCHG output pin blinks at 1HZ to indicate a fault condition.

Battery Precondition Condition State (PCOND)

The PCOND state preconditions the battery with a low charge current to avoid damage to fully discharged batteries. In this state the charger charges the battery at the IPRECHG level. The default precharge current is 10% of the fast charge current which is set by the OLIM resistor. It is adjustable between 5% and 20% of the fast charge current using the I2C bits IPRECHG[3:0] in register 0x19h.

During normal charging, the charger enters PCOND when the battery voltage is greater than VBATSHORT for 16ms.

The system continuously monitors the battery voltage and if the battery voltage is greater than the VBAT_LOW voltage threshold for 16ms, the charger exits the PCOND state and moves to the Fast Charge state. Note: If the battery voltage is above the VBAT_LOW voltage when entering this state, the charger still charges at the IPRECHG current for 16ms before moving to the Fast Charge state.

During this state, the Low Battery Safety Timer is running to detect a fault conditions or bad battery. See the Fast Charge Safety Timers section for further details. The Low Battery Safety Timer is a cumulative timer for the SCOND and PCOND states and is fixed at 2 hours.

A Low Battery Safety Timer timeout or Battery OV fault during this state causes the charger to move to the Fault State, and disable charging. An input voltage UV or OV condition also moves the state machine into the Fault state. Finally, a fault on the VREG LDO, which is not masked with the DIS_CHG_VREG_FLT register moves the state machine into the Fault state.

During this state, the VIN voltage and VIN Current regulation loops are active to ensure the input supply power ratings are not exceeded. Additionally, the thermal regulation loop is active to keep the ACT2861 junction temperature at or below the desired maximum junction temperature. See the appropriate sections for more details.

During this state the nCHG pin is pulled low to indicate charging is in progress.

Battery Precondition BAT Temp Suspend (PCSUSPEND)

This state prevents charging when the battery temperature measured by the TH pin exceeds the JEITA or Battery Temp registers settings for Hot or Cold. The state machine only enters PCSUSPEND from the PCOND state. The charger transitions back to the PCOND state and resumes charging when the temperature returns to allowable levels. The system can force the IC out of the PCSUSPEND state by disabling the TH input via I²C.

In this state, the Low Battery Safety Timer is suspended, but held at its current value. The timer resumes counting when charging resumes.

During this state the nCHG output pin blinks at 1HZ to indicate a fault condition.

Battery Fast Charge State (FASTCHG)

The Fast Charge state is the state where charger provides full charging current to the battery. The ACT2861 voltage and temperature protections ensure that the battery only enters the Fast Charge state when the conditions are safe for fast charging.

During normal charging, the charger enters FASTCHG when the battery voltage is greater than VBAT_LOW for 16ms.

If the charge current drops below ITERM for 750ms, the charger assumes the battery is charged and the state machine moves to either Charge Termination state or the Charge Full State.

In the FASTCHG state, the charger regulates the constant charging current, ICHG, until the battery voltage reaches the VBAT_REG voltage. Then it regulates the battery voltage to a constant voltage. If in voltage regulation mode and current is pulled from the battery causing its voltage to drop below VBAT_REG, the charger seamlessly switches back into constant current mode. When the battery voltage reaches the VBAT_REG voltage, the current slowly decays as the battery “tops off”. When the current drops to the termination current, ITERM, the battery is fully charged.

The VBAT_REG battery voltage can be adjusted using the I²C bits VTERM[10:0] bits in registers 0x11h and 0x12h.

The ICHG current can be controlled with the external resistor on the OLIM pin and by the I²C bits IFCHG[6:0] in register 0x18h. The I²C current adjustable is programmed as a percentage of the full current level set by the OLIM resistor.

The termination current can be adjusted using the I²C bits ITERM[3:0] in register 0x19h.

In this state, the Low Battery Safety Timer is turned off and reset. The Fast Charge Safety Timer starts running at the nominal rate to detect faults with battery charging. This timer can be adjusted between 30 minutes and 16 hours, using the I²C bits FC_SAFETY_TIMER in register 0x1Bh. If a battery temperature fault condition is detected, the charger moves to the FAULT state. See the Charge Safety Timers section for further details.

A Fast Charge Safety Timer timeout or Battery OV fault during this state causes the charger to move to the Fault State, and disable charging. An input voltage UV or OV condition also moves the state machine into the Fault state. Finally, a fault on the VREG LDO, which is not masked with the DIS_CHG_VREG_FLT register moves the state machine into the Fault state.

If the battery voltage drops below the VBAT_LOW voltage for 16ms, the charger goes back into the Battery Precondition state.

During this state, the VIN voltage and VIN Current regulation loops are active to ensure the input supply power ratings are not exceeded. Additionally, the thermal regulation loop is active to keep the ACT2861 junction temperature at or below the desired maximum junction temperature. See the appropriate sections for more details.

During this state the nCHG pin is pulled low to indicate charging is in progress.

Fast Charge Temp Suspend (FCSUSPEND)

This state prevents charging when the battery temperature measured by the TH pin exceeds the JEITA or Battery Temp registers settings for Hot or Cold. The state machine only enters FCSUSPEND from the FASTCHG state. The charger transitions back to the FASTCHG state and resumes charging when the temperature returns to allowable levels. The system can force the IC out of the FCSUSPEND state by disabling the TH input via I²C.

In this state, the Fast Charge Safety Timer is suspended, but held at its current value. The timer resumes counting when charging resumes.

During this state the nCHG output blinks at 1HZ to indicate a fault condition.

Charge Full State (CHGFULL)

The Charge Full state functionality is the same as the FASTCHG state. The charger can stay in the CHGFULL state indefinitely. It keeps a fully charged battery regulated to the VBAT_REG voltage. If something pulls current from the battery, the charger supplies current to maintain the battery voltage at VBAT_REG. The maximum charge current is still limited by the external OLIM resistor and the IFCHG[6:0] register.

During normal charging, the charger enters CHGFULL state from the FASTCHG state when the charging current drops below ITERM for greater than 750ms AND the I²C bit EN_TERM = 0.

If the charge current exceeds the ITERM current for 16ms, or if the battery voltage drops below VBAT_GOOD for 16ms, the IC exits the Charge Full state and moves back to the FASTCHG state.

A Battery Temp or Battery OV fault during this state causes the charger to move to the Fault state and disable charging. An input UV or OV condition also moves the state machine into the Fault state. Finally, a fault on the VREG LDO, which is not masked with the DIS_CHG_VREG_FLT register moves the state machine into the Fault state.

In this state, the Fast Charge Safety Timer and the Low Battery Safety Timer are reset and held at 0.

During this state the nCHG pin is HIZ to indicate the charging has completed and the Fast Charge Safety Timer is reset and held at 0.

Charge Full Suspend (CFSUSPEND)

This state prevents charging when the battery temperature measured by the TH pin exceeds the JEITA or Battery Temp registers settings for Hot or Cold. The state machine only enters CFSUSPEND from the CHGFULL state. The charger transitions back to the CHGFULL state and resumes charging when the temperature returns to allowable levels. The system can force the IC out of the CFSUSPEND state by disabling the TH input via I²C.

In this state, the Fast Charge Safety Timer is still held at 0.

During this state the nCHG output blinks at 1HZ to indicate a fault condition.

Battery Termination State (CHGTERM)

In this state, the charger is disabled and does not supply any current to the battery. It monitors the battery voltage to check for the condition when the battery voltage drops to VTERM-VRECHARGE. The VRECHARGE voltage is typically 100mV or 150mV per cell. Once the battery voltage drops below the threshold, the IC enters the Fast Charge state and recharges the battery.

During normal charging, the charger enters this state when the charging current drops below ITERM for greater than 750ms AND the I²C bit EN_TERM = 1.

In this state, the Fast Charge Safety Timer and the Low Battery Safety Timer are reset and held at 0.

A Battery Temp or Battery OV fault during this state causes the charger to move to the Fault state and disable charging. An input UV or OV condition also moves the state machine into the Fault state. Finally, a fault on the VREG LDO, which is not masked with the DIS_CHG_VREG_FLT register moves the state machine into the Fault state.

The nCHG pin is HIZ to indicate the charging has completed and the Fast Charge Safety Timer is reset and held at 0.

Charge Termination Suspend (CTSUSPEND)

This state prevents charging when the battery temperature measured by the TH pin exceeds the JEITA or Battery Temp registers settings for Hot or Cold. The state machine only enters CTSUSPEND from the CHGTERM state. The charger transitions back to the CHGTERM state and resumes charging when the temperature returns to allowable levels. The system can force the IC out of the CTSUSPEND state by disabling the TH input via I²C.

In this state, the Fast Charge Safety Timer is still held at 0.

During this state the nCHG output blinks at 1HZ to indicate a fault condition.

Fault Mode (FAULT)

This state protects the battery against all system level faults by disabling the charger and preventing any additional current to go to the battery.

The charger enters the FAULT state if any of the following occurs:

1. Fast Charge Safety Timer Timeout – If the timer exceeds the setting in the FC_SAFETY_TIMER[4:0] register 0x1Bh, then the charger enters the FAULT state. It stays in the FAULT state until this timer is reset with the I²C bit DIS_SAFETY_TIMER in register 0x1Bh. Any condition that clears the Fast Charge Safety timer makes the charger exit the FAULT state and returns the charger to the RESET state to start charging again. The Fast Charge Safety timer can be reset by setting the I²C bit DIS_SAFETY_TIMER = 1. The charger also exits the FAULT state if the IC is enters HIZ or SHIPMODE. Refer to the Operating Modes State Machine Diagram for more details.

2. Low Battery Safety Timer Timeout – If the timer exceeds 120 minutes for the states when VBAT is less than VBAT LOW, then the charger enters the FAULT state. It stays in the FAULT state until this timer is reset with the I²C bit DIS_SAFETY_TIMER in register 0x1Bh. Any condition that clears the Low Battery Safety Timer makes the charger exit the FAULT state and returns the

charger to the RESET state to start charging again. The Low Battery Safety Timer can be reset by setting the I²C bit DIS_SAFETY_TIMER = 1. The charger also exits the FAULT state if the IC is enters HIZ or SHIPMODE. Refer to the Operating Modes State Machine Diagram for more details.

3. VBAT OV Fault – This fault can be latching or non-latching depending on the I²C bit DIS_VBAT_OVP in register 0x01h setting. If DIS_VBAT_OVP=0, then a battery overvoltage fault is latching. This requires the IC to exit the Charge state to exit the charger FAULT state. Exit the Charge state with the EN_CHG pin or any other method shown in the Operating Modes State Machine Diagram

If DIS_VBAT_OVP=1, then a battery overvoltage fault is not latching. The charger exits the FAULT state and returns to the RESET state when the overvoltage fault clears.

A 40msec deglitch timer is available to prevent false OV fault detection due to noise or short battery voltage transients. The I²C bit VBAT_OV_DEGLITCH_EN in register 0x0Bh sets the deglitch time. Setting this bit = 1 gives a 40ms deglitch time. Setting it = 0 gives a 5us deglitch time.

4. VIN OV or VIN UV Fault – If the VIN voltage exceeds the UVLO or OVLO thresholds, the charger stops charging and enters the FAULT state. Once the input voltage returns to an acceptable level, the IC returns to the RESET state to restart the charging process.

5. VREG LDO Fault – If the VREG LDO is not within regulation or in an overcurrent condition, the charger enters the FAULT state. Once the fault condition has been removed from the LDO, the charger returns to the RESET state to restart the charging process. This fault can be ignored, if I²C bit DIS_CHG_VREG_FLT in register 0x0Dh = 1. If this bit = 1, the charger does NOT go to the FAULT state with a VREG LDO fault.

6. Die Thermal Shutdown (TSD) – If the die temperature exceeds TSHUT (160°C) the charger moves into the FAULT state until it cools down by the thermal hysteresis, TSHUT_HYST (30°C). This fault cannot be cleared or masked. The IC must cool down before exiting the FAULT state. Once the IC cools down, it automatically clears this fault, exits the FAULT state, and returns to the RESET state to resume charging.

7. Watchdog Fault – If the watchdog timer is enabled and the timer ties out, the Watchdog fault holds the charger in the FAULT state until the watchdog timer is reset or cleared. It can be reset by writing a 1 to the I²C bit WATCHDOG_RESET or by disabling the Watchdog timer with I²C bit WATCHDOG[1:0]=00.

8. FET_OC – If any of the FET currents reach the over-current limit threshold for 16 cycles in a row, the IC enters FET_OC fault. The fault latches and the IC must EXIT the Charge state to clear the latch. Exit the Charge state with the EN_CHG pin or any other method shown in the Operating Modes State Machine Diagram

When the IC is in the FAULT state, the switching charger is disabled and the charge current to the battery is 0A.

When in the FAULT state, the nCHG pin blinks at a 1HZ rate to indicate a fault condition.

OTG STATE MACHINE

The ACT2861 has a dedicated OTG state machine. This state machine handles the startup, normal operation and fault conditions in OTG mode.

OTG Reset State (OTG_RST)

The OTG state machine always starts from the OTG_RST state. All OTG operation starts from this state. In this state, the switcher is disabled and the state machine is waiting for all the required conditions to move to the OTG_SS state.

After all the following fault conditions are cleared, the IC starts the OTG Enable Delay Timer. This timer is controlled by I²C bit OTG_EN_DLY[1:0] in register 0x0Fh. Once the timer has expired, the state machine moves to the OTG_SS state.

OTG Reset Faults:

OTG_VBAT_CUTOFF voltage: This fault is active when the battery voltage is lower than the programmed OTG battery cutoff voltage. The cutoff voltage is set by I²C bit OTG_VBAT_CUTOFF in register 0x0Fh. This fault self-clears when VBAT is higher than the OTG battery cutoff voltage.

VREG LDO OK – This fault is set when an LDO fault is detected. This includes the 100msec timeout period. This fault automatically clears when the VREG LDO has exited the faulted condition. Note: This fault can be masked to allow the state machine to exit OTG_RST while there is a fault on the VREG LDO by using the I²C bit DIS_OTG_VREG_FLT in register 0x10 Bit 1.

OTG HOT or OTG COLD: This fault is active if the battery temperature as detected on the TH pin is above or below the programmed temperature thresholds. This fault self-clears when the battery temperature goes back into the allowable range.

Watchdog Timer Fault: This fault is active if the watchdog timer is enabled and the timer times out. This fault

clears when the watchdog timer is reset or cleared. It can be reset by writing a 1 into the I²C bit WATCHDOG_RESET in register 0x00h. It can be cleared by disabling the watchdog timer by setting I²C bits WATCHDOG[1:0] = 0x00h.

During this state, the Fast Charge Safety and Low Battery Safety Timer timers are suspended and held at their current value.

FET Overcurrent Fault: This fault is set if a switching FET exceeds the cycle-by-cycle current limit for 8 (or 16) consecutive cycles. The FET_OC fault is latched. To clear this latch, the IC must exit the OTG mode and enter HIZ mode. This is typically accomplished by toggling the nOTG pin or setting the HIZ register to 1.

VBAT Overvoltage: This fault is set if VBAT exceeds the V_{OTG_BAT_OV} voltage. The OV fault self-clears when VBAT drops below V_{OTG_BAT_OV} and the IC exits the OTG_RST state.

Die Thermal Shutdown (TSD): This fault is active when die temperature exceeds the T_{SHUT} (160°C) temperature. This fault self-clears when the die temperature cools down by the temperature hysteresis, T_{SHUT_HYST} (30°C). This fault cannot be cleared or masked. The IC must cool down before exiting the OST_RST state.

OTG Softstart State (OTG_SS)

In this state, the IC enables the converter and softstarts the OTG output voltage.

The state machine enters OTG_SS from the OTG_RST state when all faults are cleared. The state machine transitions to the OTG_REG state after the OTG output is softstarted and in regulation.

The softstart time is controllable by the I²C bit OTG_SS in register 0x0Eh. If a fault occurs during the softstart, the state machine jumps back to the OTG_RST state and disables the converter. Once the soft start is done, the IC jumps to the OTG_REG state.

OTG Regulation State (OTG_REG)

The normal regulation occurs in the OTG_REG state. If a major fault occurs during operation the IC will jump back to the reset state and disable the converter. During this state, the converter can be disabled with a light load condition. Additionally, if the output drops below V_{OTG_UVP} (3.0V), the IC will go into a hiccup mode to protect the output in a shorted condition.

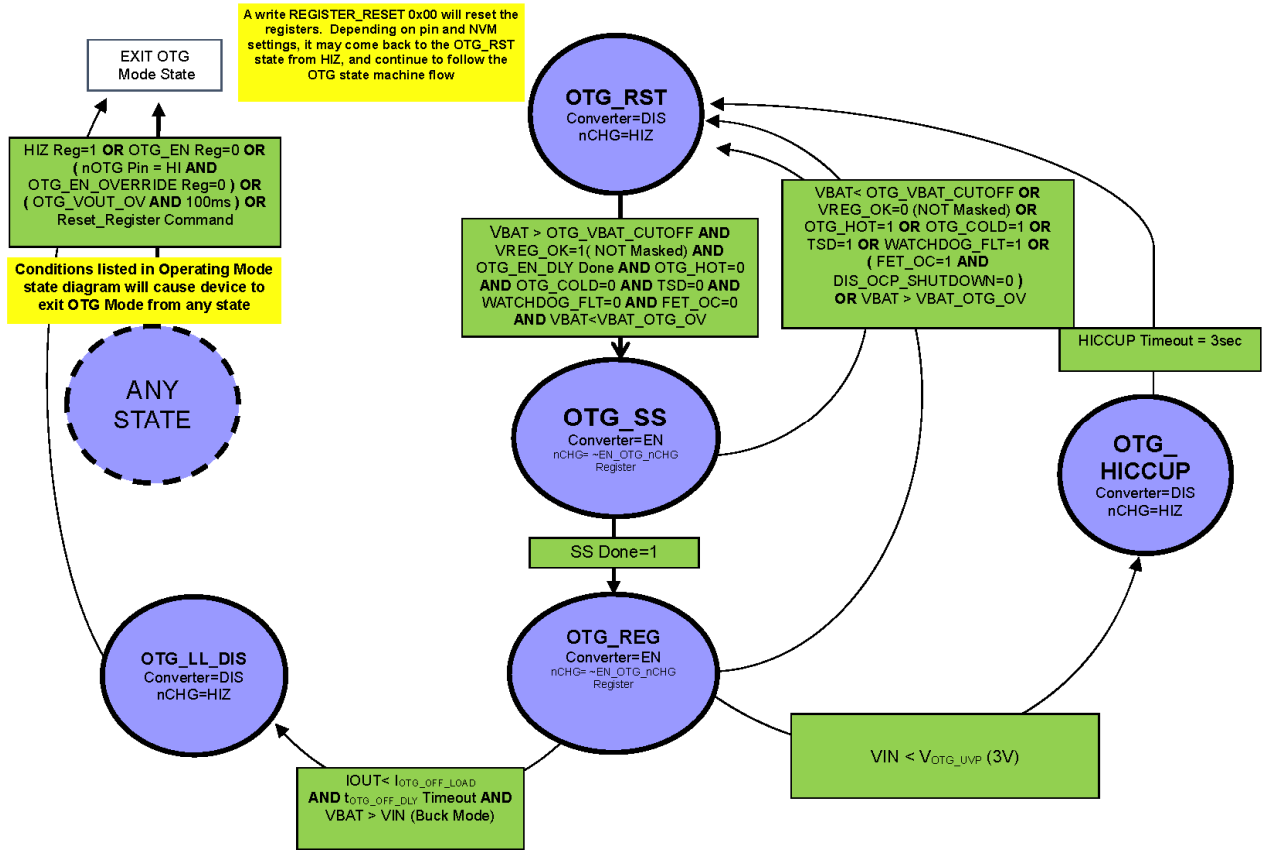

Figure 5: OTG State Machine Diagram

OTG Light Load Disable State (OTG_LL_DIS)

In the state, the converter is disabled to minimize load on the battery. It prevents the converter from switching with no load.

The state machine enters OTG_LL_DIS when it senses a light load for longer than the light load time out time. This time is set by I²C bit OTG_OFF_DLY[1:0] in register 0x0Eh. Note that the converter only enters OTG_LL_DIS when operating in buck mode. It does not enter OTG_LL_DIS when in boost or buck-boost mode.

The state machine can only exit OTG_LL_DIS when the IC exits the OTG Mode by the nOTG pin or HIZ register.

OTG Hiccup / Vout Fault State (OTG_HICCUP)

This state is a fault state that minimizes overall IC power dissipation in extreme output overload conditions.

The state machine enters this state when the OTG output cannot support the load. When the OTG output reaches the maximum programmed output current, it clamps the current and the voltage starts to drop. If the load increases, the output voltage drops even further. If

it drops below V_{OTG_UVP} (3.0V), the converter is disabled for 3s. After 3s, it automatically moves to OTG_RST and restarts. If there is a fault on the output, this cycle continues until the fault is removed.

PIN FUNCTIONS

VIN

VIN is the ACT2861 input power pin when in CHARGE mode. It is also the input voltage sense input. VIN is the ACT2861 output power pin when in OTG mode. The OTG output voltage is regulated at the VIN pin. Connect input bypass capacitors directly between VIN and PGND.

ISRP

ISRP is the positive sense pin for input current sensing when the ACT2861 is in Charge mode. It is the negative sense pin for output current sensing when the IC is in OTG mode. ISRP requires an input RC filter. Refer to the **Setting Charge Current** section for more details. ISRP must be Kelvin connected to the input current sense resistor. Connect the input current sense resistor between ISRP and ISRN.

ISRN

ISRN is the negative sense pin for input current sensing when the ACT2861 is in Charge mode. It is the positive sense pin for output current sensing when the IC is in OTG mode. ISRN requires an input RC filter. Refer to the **Setting Charge Current** section for more details. ISRN must be Kelvin connected to the input current sense resistor. Connect the input current sense resistor between ISRP and ISRN.

SW1, SW2

SW1 and SW2 are the switch nodes for the internal buck-boost converter. SW1 switches between VIN and PGND when the IC operates in buck and buck-boost modes. SW2 switches between VBAT and PGND when the IC operates in buck-boost and boost modes. Connect the inductor between the SW1 and SW2 pins.

HSB1, HSB2

HSB1 and HSB2 provide power to the internal high-side MOSFET gate driver circuitry. Connect a 47nF capacitor from HSB1 to SW1. Connect a 47nF capacitor from HSB2 to SW2.

VBAT

VBAT is the battery charger output power pin when in CHARGE mode. Is the input power pin in OTG mode. Connect input bypass capacitors directly between VBAT and PGND.

VBATS

VBATS is the battery voltage sense pin. The battery voltage is regulated at the VBATS pin. Kelvin connect input VBATS as close to the battery input terminals as possible.

OSRP

OSRP is the positive sense pin for battery charge current sensing when the ACT2861 is in Charge mode. It is the negative sense pin for the input battery current sensing when the IC is in OTG mode. OSRP requires an input RC filter. Refer to the **Setting Charge Current** section for more details. OSRP must be Kelvin connected to the battery charge current sense resistor. Connect the battery charge current sense resistor between OSRP and OSRN.

OSRN

OSRN is the negative sense pin for battery charge current sensing when the ACT2861 is in Charge mode. It is the positive sense pin for input battery current sensing when the IC is in OTG mode. OSRN requires an input RC filter. Refer to the **Setting Charge Current** section for more details. OSRN must be Kelvin connected to the battery charge current sense resistor. Connect the battery charge current sense resistor between OSRP and OSRN.

ILIM

ILIM sets the maximum input current in CHARGE mode. It sets the maximum output current in OTG mode. Connect a resistor between ILIM and AGND to set the current limits. The ILIM current limit can be scaled using I²C. In some operating conditions, ILIM requires additional RC compensation. Refer to the **Charging – Maximum Current Input** section for more details.

OLIM

OLIM sets the maximum battery charge current in CHARGE mode. It sets the maximum battery input current in OTG mode. Connect a resistor between OLIM and AGND to set the current limits. The OLIM current limit can be scaled using I²C. In some operating conditions, OLIM requires additional RC compensation. Refer to the **Setting Charge Current** section for more details.

INTBP

INTBP is the internal bias voltage output pin. INTBP is supplied by an internal linear regulator. Do not power external circuitry from the INTBP pin. Connect a 100nF ceramic capacitor between INTBP and AGND.

VREG

VREG is the internal LDO output pin. The internal LDO is programmable between 2V and 5.1V. Its maximum output current capability 100mA. Connect a 1uF ceramic capacitor between VREG and AGND

TH

TH is the battery temperature sense input. Connect a negative temperature coefficient thermistor from TH to AGND. This pin provides a constant current output and the voltage at this pin is used to calculate the battery temperature. If temperature sensing is not used, leave TH open and set register bit "DIS_TH" to a 1

nOTG

nOTG is the active low OTG enable input. Pulling nOTG low enables OTG mode when I²C bit EN_OTG is set. The nOTG polarity is configurable via NVM to make it active low or active high. Active low is the default. nOTG is 5V compliant.

EN_CHG

EN_CHG is the active high charge enable input. Pulling EN_CHG high enables the charger. EN_CHG is 5V compliant.

nCHG

nCHG is an open drain charge status pin. It indicates the charger status. It goes low to indicate that charging is in progress. It goes HIZ to indicate charging is complete or disabled. When fault condition occurs, nCHG blinks at 1HZ. See Charge Status Pin (nCHG) section for list of faults and further description.

ICOMP/GPIO

ICOMP/GPIO is a dual function pin. It is the OTG mode compensation pin. Connect the compensation components between ICOMP/GPIO and AGND. If OTG mode is not used, this pin can be programmed to be a GPIO via I²C.

A2D

This is the A2D input. Connect this pin directly to the voltage to be measured. Note that the ADC full scale input voltage is 2.5V.

nIRQ

ACT2861 has an interrupt pin to inform the host of any fault conditions. In general, any IC function with a status bit asserts nIRQ pin low if the status changes. The status changes can be masked by setting their corresponding register bits. If nIRQ is asserted low, the fault must be read before the IC deasserts nIRQ. If the fault remains after reading the status bits, nIRQ remains asserted. Refer to the **nIRQ Interrupt Pin (nIRQ)** section for more details.

nIRQ is an open-drain output and should be pulled up to an appropriate supply voltage with a 10kΩ or greater pull-up resistor. nIRQ is 5V compliant

SHIPM

SHIPM is the SHIP mode pin. If the IC is in SHIP mode, pulling it low for 32ms moves the state machine to the HIZ state which enables IC to startup into either CHARGE mode or OTG mode. If not used, connect SHIPM to AGND.

SCL, SDA

SCL and SDA are the I²C clock and data pins to the IC. They have standard I²C functionality. They are open-drain outputs and each require a pull-up resistor. The pull-up resistor is typically tied to the system's uP IO pins. The pullup voltage can range from 1.8V to 5.0V. SCL and SDA are open drain and are 5V compliant.

PGND

The PGND pin is the buck-boost converters' power ground. The internal FETs connect directly to the PGND pins. The power supply input and output capacitors must connect to the PGND pins.

AGND

The AGND pin is the IC's analog ground pin. It is a "quiet" ground pin that is separate and isolated from the high power, high current carrying PGND ground plane. Connect the non-power components to AGND. AGND must be Kelvin connected to the PGND pin in a single location.

Exposed PAD

The Exposed pad is connected directly to the PGND pins and must be soldered to the top side ground plane. Place thermal vias under the Exposed PAD to improve the IC's thermal performance.

BUCK-BOOST OPERATION

The ACT2861 is a monolithic buck-boost charger with On-The-Go (OTG). As a result, it can operate in both charge mode and OTG mode. In charge mode, the IC converts power from VIN to VBAT to charge a 2S to 5S battery. In OTG mode, it converts power from the battery to VIN to provide a regulated output voltage. Four internal, low resistance, NMOS switches minimize the application circuit size and reduce power losses to maximize efficiency. Internal high side gate drivers, which require only two small external capacitors, further simplify the design process. An advanced switch control algorithm allows the buck-boost converter to maintain charge or OTG output voltage regulation with input voltages that are above, equal to, or below the regulated output voltage. The ACT2861 automatically transitions between these three operating modes, depending on the input to output voltage ratios.

Power Stage

Figure 6 shows the 4-switch, buck-boost power stage. The converter operates with current mode control. The internal control algorithm reconfigures the IC between a buck, a boost, and a buck-boost topology as needed. This reduces power dissipation and maximizes efficiency because only two FETs switch when in it operates in buck or boost mode. Table 2 shows the switch configuration in each topology. Note that this table is valid for Charge mode. In OTG mode, power flows in the opposite direction, so the switching modes are reversed. The voltage transition between buck to buck-boost and from buck-boost to boost modes is set by I²C bits XOVER_ADJ_BUCK and XOVER_ADJ_BOOST. With a fixed input voltage and an increasing battery voltage, the IC switches from buck mode to buck-boost mode when $V_{IN} - V_{BAT} < XOVER_ADJ_BUCK$, which is typically 1V. It switches from buck-boost to boost mode when $V_{BAT} - V_{IN} > XOVER_ADJ_BOOST$, which is typically 2V. These values are set at the factory to optimize efficiency and performance for each CMI.

The power stage is bi-directional and provides power in both directions. When charging, power flows from VIN to VBAT. In OTG mode, power flows from VBAT to VIN. Q1-Q4 are all internal, N-ch MOSFETs to minimize size and maximize efficiency.

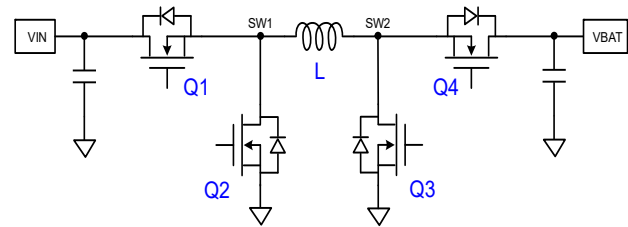

Figure 6: 4-Switch Buck-Boost Power Stage

Table 2: Buck-Boost Switch Configuration

	CHARGE MODE		
	BUCK	BUCK-BOOST	BOOST
Q1	SWITCHING	SWITCHING	ON
Q2	SWITCHING	SWITCHING	OFF
Q3	OFF	SWITCHING	SWITCHING
Q4	ON	SWITCHING	SWITCHING

Figure 7 shows the power stage operating modes. A typical example of how the converter switches between modes can be explained with an example using a 15V input source to charge a 4S Li-Ion battery. When fully discharged, the battery voltage is 12V. With $V_{IN}=15V$ and $V_{BAT}=12V$, the control loop operates in Buck mode at point A. As the battery charges, the operating mode maintains buck mode until it crosses the threshold between buck mode and buck-boost mode. When the batteries are charged at 15V, the control loop operates at point B in Buck-Boost mode. The 4S battery reaches charge termination voltage at 17.4V. In this case, the control loop operates at point C, which is still Buck-Boost mode. If the input voltage dropped from 15V to 12V, the control loop will move to point D and operate in Boost mode.

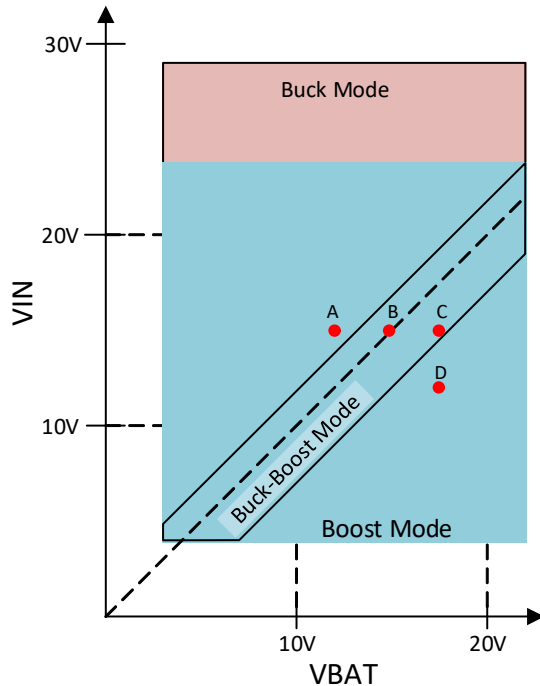

Figure 7: ACT2861 Operating Modes

PFM/PWM Operation

At light loads, the ACT2861 operates in the PFM (pulse skipping) mode to reduce switching losses in Charge mode and OTG mode. PFM mode can be disabled by the I²C bit OTG_DIS_PFM/CHG_DIS_PFM in register 0x10h. Setting this bit to 0 enables PFM mode. Setting this bit to 1 forces PWM mode. This bit controls both Charge mode and OTG mode.

Out-of-Audio Mode

When the IC operates in PFM mode, it reduces the switching frequency. At very light loads, the IC can switch in the audio range. The ACT2861 features an Out-of-Audio mode that prevents switching below 31.25kHz. Set the I²C bit AudioFreqLimit = 1 to enable this feature.

GENERAL DESCRIPTION

Startup

When power is first applied, the ACT2861 always starts up in SHIP mode. If only a battery is present, the IC remains in SHIP mode until the SHIPM pin is pulled to ground. The IC then enters HIZ mode where its internal LDO, VREG, is enabled. In HIZ mode, the IC can communicate via I²C.

If power is applied to VIN, the ACT2861 powers up into SHIP mode and then transitions to HIZ mode when the voltage goes above 3.9V. At this time, the internal POK, power ok, signal is released and all registers are reset to their default values.

Depending on the EN_CHG and nOTG inputs, the IC then either stays in HIZ mode or moves to the OTG or CHARGE modes.

VREG LDO

The ACT2861 contains a 100mA internal linear regulator that can be used to power other circuitry in the system. VREG is enabled when the IC enters HIZ mode and the following two conditions are valid:

VIN is above UVLO (3.9V) or VBAT is above VBATUVLO (3.9V)

I²C bit VREG_DIS in register 0x01h = 0. This register bit can be programmed Hi or Low from the factory to match system level requirements.

The VREG output voltage is programmable between 2.0V and 5.1V in 100mV steps via I²C bits VREG[4:0] in register 0x11h.

$$V_{VREG} = 2.0V + 0.1V * VREG[4:0].$$

Where VREG[4:0] is the decimal equivalent of the value in this register. For example, if VREG[4:0] = 01101b (13 decimal), the output voltage = 2.0V + 0.1V * 13 = 3.3V.

The VREG input can come from either the VIN pin or the VBAT pin. The ACT2861 contains a Smart Diode Selector input that minimizes power dissipation by selecting the lower of these two input sources. When the IC operates in OTG Mode or Charger Mode, the IC powers VREG from the lower of the VIN or VBAT pins. However, if the lower voltage pin cannot provide the headroom needed to regulate VREG, it selects the higher voltage pin. When the converter is in HIZ mode, VREG is powered from VIN when possible. If VIN is not present or is not high enough to support the programmed output voltage, VREG is powered from VBAT.

The Smart Diode Selector can be overridden and manual control can be selected using the I²C bits VREG_OVERRIDE and VREG_SELECT in register

0x0Bh. When VREG_OVERRIDE = 0, the Smart Diode Selector is active. When VREG_OVERRIDE = 1, the VREG input is determined by VREG_SELECT. When VREG_SELECT = 0, the input is VIN. When VREG_SELECT = 1, the input is VBAT.

If VREG LDO is overloaded or not within spec, the buck-boost converter shuts down, and I²C fault bit VREG_OC_UVLO in register 0x05h is set to 1.

Additionally, if VREG is held in current limit for more than 90us, it shuts down for 100ms to prevent damage. It tries to restart after 100ms. It continues this cycle until the current limit condition is removed. VREG also contains UVLO detection, which is set to 88% of the programmed output voltage.

If the VREG output is in current limit for 90usec, or the VREG voltage is below the UVLO threshold while the IC is in Charge mode, the charger state machine moves to the FAULT state and stops charging. If in OTG mode, the OTG state machine moves to the OTG_RST state. In both cases, the buck-boost converter stops switching. VREG can be programmed to ignore an overvoltage or undervoltage fault with I²C bits DIS_CHG_VREG_FLT in register 0x0Dh and DIS_OTG_VREG_FLT in register 0x10h. If these bits are set to 1, Charge or OTG mode continue to operate through the fault condition.

VREG requires a high quality, low-ESR, ceramic output capacitor. A 1uF is typically suitable, but this value can be increased without limit. The output capacitor should be a X5R, X7R, or similar dielectric. The effective output capacitance must be greater than 0.7uF to ensure LDO stability.

VREG contains a fixed 250us soft-start to reduce inrush current.

Interrupt Output Pin (nIRQ)

The nIRQ output pin can be used to signal a fault or other system effects. The conditions below can assert the nIRQ pin. All fault conditions can be individually masked using the I²C nIRQ Control Registers 0x1Eh, 0x1Fh, and 0x20h. To clear the interrupt and de-assert the nIRQ pin, write a 1 into I²C bit nIRQ_CLEAR in register 0x05h. nIRQ_CLEAR is a self-clearing register bit. nIRQ_CLEAR always returns a 0 when read, even after it is set to 1.

General nIRQ Fault Conditions

1. **Watchdog Expired** - If the watchdog timer expires at any time, it asserts nIRQ. This is a level sensitive function. The watchdog timer must be reset or disabled and a 1 must be written into nIRQ_CLEAR to de-asserted nIRQ.

2. **VREG LDO Overcurrent or Under-voltage Lockout** - Any time the VREG LDO is in overcurrent or under-voltage lockout, nIRQ is asserted. This is a level sensitive function. VREG must be in regulation AND a 1 must be written into nIRQ_CLEAR to deassert nIRQ. If the VREG LDO is in the 100ms shutdown wait period, it will not clear the nIRQ output. This fault is detected in HIZ mode, Charge Mode, and OTG Mode.
3. **Battery voltage is lower than V_{BAT_GOOD}** - Any time the VBAT pin voltage falls below the V_{BAT_GOOD} threshold, nIRQ is asserted. This is an edge triggered function after a 16ms deglitch. Write 1 to into nIRQ_CLEAR to deassert nIRQ. V_{BAT_GOOD} is not checked in HIZ mode, so nIRQ is not triggered in HIZ mode. If VBAT is lower than V_{BAT_GOOD} in HIZ mode, nIRQ is not triggered, but it is immediately triggered when the IC moves into the Charge or OTG modes.
4. **Over Temperature Shut Down** - Any time the die temperature exceeds the T_{SHUT} (160°C) threshold, nIRQ is asserted. This is a level sensitive function. The die temperature must be below the T_{SHUT_HYST} AND a 1 must be written into nIRQ_CLEAR to deassert nIRQ. Die TSD is active in all modes.
5. **FET Overcurrent Fault** - If the IC is disabled from switching because of a FET overcurrent fault, nIRQ is asserted. This is a level sensitive function. This fault is latched, so the latch must be cleared by manually going into HIZ Mode AND a 1 must be written into nIRQ_CLEAR to deassert nIRQ. This fault can only be triggered in CHG or OTG mode.
6. **ADC Data Ready** - If the ADC is enabled, and a conversion is completed, nIRQ is asserted. This is an edge triggered event. A 1 must be written into nIRQ_CLEAR to deassert nIRQ. This is active in all modes when the ADC is enabled.
7. **HIZ Enter** - The ACT2861 asserts nIRQ when it enters HIZ mode. This is an edge triggered event. 1 must be written into nIRQ_CLEAR to deassert nIRQ. The IC asserts nIRQ when entering HIZ mode to signal a fault or other condition that might have caused the IC to jump out of charge mode or OTG mode un-expectedly.
8. **I²C Fault** - If an I²C command takes more than 100ms between the start bit and the stop bit, nIRQ is asserted. This is an edge triggered

event. The I²C state machine clears out any partial data, resets, and waits for another start bit for another I²C command. The state machine clears and restarts the 100ms timer when it receives the next start bit.

9. **Input VIN OV (30V)** – If VIN is above V_{IN_OVP} (30V), nIRQ is asserted. This is a level triggered event. This fault is detected in HIZ mode, Charge Mode, and OTG Mode.
10. **VBAT Above V_{OTG_VBAT_OV} (23.5V)** - If VBAT is above V_{OTG_VBAT_OV} (23.5V), nIRQ is asserted. This is a level triggered event. 1 must be written into nIRQ_CLEAR to deassert nIRQ. This fault is detected in HIZ mode, Charge Mode, and OTG Mode.

Charge Mode nIRQ Conditions

1. **Input Undervoltage** - Any time VIN is below V_{IN_UVLO} (3.9V) threshold, nIRQ is asserted. This is a level triggered event. VIN must be in the valid range and high AND 1 must be written into nIRQ_CLEAR to deassert nIRQ.
2. **Fast Charge Safety Timer Expired** – If the Low Battery Safety Timer expires or the Fast Charge Safety Timer expires during charge mode, nIRQ is asserted. This is level triggered event. The safety timers must be cleared AND 1 must be written into nIRQ_CLEAR to deassert nIRQ. The fault timers can be cleared via I²C or by exiting and re-entering Charge mode.
3. **Charge Completed** – When the IC's Charge state machine moves from the FASTCHG state to the CHGFULL or CHGTERM states, nIRQ is asserted. This is an edge triggered event. 1 must be written into nIRQ_CLEAR to deassert nIRQ. Note that the state machine can stay in the CHGFULL or CHGTERM states without re-asserting nIRQ.
4. **Battery Overvoltage** - If the VBAT pin voltage exceeds the VBAT Overvoltage threshold V_{BA_TOVP} during Charge mode, nIRQ is asserted. This is a level triggered function. The battery voltage must be below VBAT OVP AND a 1 must be written into nIRQ_CLEAR to deassert nIRQ.
5. **Battery Temp Suspend** – If the battery temperature measured by the TH pin exceeds the JEITA or Battery Temp registers settings for Hot or Cold and causes the Charging state machine to move to a suspend mode, nIRQ is asserted. This is an edge triggered event. A 1

must be written into nIRQ_CLEAR to deassert nIRQ.

OTG Mode nIRQ Conditions

1. **OTG Mode Battery Cutoff** – If the VBAT pin voltage is below the V_{OTG_VBAT_CUTOFF} threshold, nIRQ is asserted. This is a level triggered event. VBAT must be in the valid range AND 1 must be written into nIRQ_CLEAR to deassert nIRQ.
2. **OTG Light Load Disable State** - Any time the IC enters the OTG_LL_DIS state, nIRQ is asserted. This is an edge triggered event. A 1 must be written into nIRQ_CLEAR to deassert nIRQ. The IC does not need to exit the OTG_LL_DIS state to de-assert nIRQ.
3. **OTG Hiccup Mode / Vout Fault State** - Any time the IC enters the OTG_HICCUP state, nIRQ is asserted. This is an edge triggered event. A 1 must be written into nIRQ_CLEAR to deassert nIRQ.
4. **Battery Temperature** – If the battery temperature measured by the TH pin exceeds the JEITA or Battery Temp registers settings for Hot or Cold and causes the OTG state machine to move to the OTG_RST state, nIRQ is asserted. This is an edge triggered event. A 1 must be written into nIRQ_CLEAR to deassert nIRQ.

Die Thermal Regulation

The ACT286x monitors the internal junction temperature, T_J, to avoid overheating. When T_J exceeds the maximum thermal regulation limit set by I²C bits TREG[1:0], the IC reduces the output current to lower the die temperature. This function works in both Charge mode and OTG mode. In Charge mode, the IC reduces the charging current. This has no effect other than to lengthen the charging time. In OTG mode, it reduces the output current limit value. If the load current is not reduced, the OTG output voltage will drop and generate an OTG undervoltage fault. The maximum operating junction temperature is programmable to 80°C, 100°C, or 120°C to allow the user to optimize their system thermal performance. This function can be disabled by setting TREG[1:0] = 00.

When Thermal Regulation is active in Charge mode, the Low Battery Safety and Fast Charge Safety Timers both run at ½ speed to increase the overall safety timeout window.

SHIP MODE

The ACT2861 contain a SHIP MODE feature that reduces battery current consumption to 1uA. This is especially useful when a battery powered application is shipped to the store and sits on the shelf for long periods of time. In SHIP MODE the IC turns off all functions except the SHIPM pin and the VIN voltage detection circuitry. The IC state machine always starts in SHIP MODE state. There are two ways to exit SHIP MODE.

Apply a valid input voltage to the VIN pin for more than 32ms.

Pull the SHIPM pin to ground for greater than 32ms.

IC always transitions to the HIZ MODE before moving to the CHARGE or OTG modes.

After the IC has exited SHIP MODE, there are three ways it can be put back into SHIP MODE.

1. The IC automatically enters Ship mode when the VIN and VBAT voltages drop below 1V.
2. Write a 1 into I²C bit SHIPM_ENTER in register 0x00h. After the write command is complete, the IC stays enabled for 1s to allow the system to properly power down. After 1s, the IC enters SHIP MODE and the SHIPM_ENTER bit is reset to 0. During the 1s timer count down, the SHIPM_ENTER bit stays high. Writing a 0 into SHIPM_ENTER before the 1s timer expires resets the timer and cancels the command.
3. Pull the SHIPM pin above 4.5V for 32ms. This function is immediately edge triggered after 32ms, and there no 1s delay.

While in SHIP MODE, the SHIPM pin is pulled up to approximately 3V with a 1MΩ pullup resistor. Once IC has exited SHIP MODE, the SHIPM pin is pulled to GND with a 1Meg resistor to reduce quiescent current.

If SHIP MODE is not required, connect the SHIPM pin to GND. With this configuration, when power is applied to VIN or VBAT, the IC powers up into SHIP MODE for 32ms and then moves into HIZ mode. Note that the SHIPM pin has a 1.5V logic threshold (1.5V) so it can be diode OR'ed with a diode to external circuitry like a Push Button or digital output from an external GPIO.

HIZ Mode

The ACT2861 HIZ mode is a low power state where the buck-boost converter is disabled. The LDO can be enabled or disabled by I²C bit VREG_EN in register 0x01h. The IC always starts up in SHIP MODE and then transitions to HIZ mode before going to either OTG or Charge mode. If OTG or Charge modes are not enabled,

the IC stays in HIZ state indefinitely. Refer to the Charging and OTG sections for the details to transition from HIZ mode to those modes.

To enter HIZ mode from SHIP mode, pull VIN pin high or pull the SHIPM pin low for > 32ms. The IC enters HIZ mode from OTG or Charge modes when OTG or charging are disabled or if a 1 is written into I²C bit HIZ in register 0x00h.

Thermal Shutdown

The ACT2861 has thermal shutdown protection that disables the buck-boost converter when IC junction temperature exceeds T_{SHUT} (160°C). The fault register TSD is set to 1 and latched when a TSD fault is detected. In Charge Mode and OTG Mode, the converter restarts automatically after the junction temperature falls below T_{SHUT} - T_{SHUT_HYST}, or approximately 160°C - 30°C = 130°C. After the system restarts, the TSD bit is latched until it is read by I²C.

FET Over Current Protection

The ACT286x closely monitors the HSFETs and LSFETs currents for safe operation. If any FET exceeds the maximum cycle-by-cycle current limit threshold set by I²C bit FET_ILIMIT in register 0x01h, the FET is immediately turned off for that switching cycle. Two thresholds of 8.5A and 10A are available. If a FET detects the current limit for eight continuous cycles, the buck-boost converter is latched off. This protection is valid in both Charger Mode and OTG Mode.

After FET Overcurrent protection is triggered, there are two ways to clear the fault to let the converter resume normal operation. First is to set I²C bit DIS_OCP_SHUTDOWN = 1 in register 0x01h. It can also be cleared by putting the IC into HIZ mode. In OTG mode, toggle the nOTG pin to put the IC into HIZ mode and then restart OTG mode. In Charge mode, toggle the EN_CHG pin.

Overcurrent protection can be disabled by setting the I²C bit DIS_OCP_SHUTDOWN = 1.

Watchdog Timer

The ACT2861 contains a watchdog timer to detect system level communication failures. The watchdog timer requires the host to periodically write a 1 into I²C bit WATCHDOG_RESET in register 0x00h. If the host latches up or is unable to perform the write command before the watchdog timer times out, the IC enters FAULT mode and disables the switching converter. The timer resets after each write to WATCHDOG_RESET. WATCHDOG_RESET is an auto-clearing register. It automatically resets back to 0 after it is set to 1.

The timeout value is controlled by I²C bit WATCHDOG[1:0] in register 0x01h. It can be set between 80s and 320s. If the IC is used in stand-alone operation, the watchdog timer can be disabled by setting WATCHDOG[1:0] = 00.

WATCHDOG is always disabled in HIZ Mode and cannot be enabled in HIZ. In addition, the timer is reset to 0 when entering HIZ mode and automatically starts counting when exiting HIZ mode into OTG or Charge Mode.

Battery Charge Management

The ACT2861 charges 2 ~ 5 cell Li-Ion battery with up to 5A charge current for high capacity batteries. The default charging profile is configured for Li-Ion batteries, but the ACT2861 I²C configurability allows the IC to charge any battery chemistry.

Autonomous (stand-alone) Charging Cycle

With battery charging enabled at POR, the ACT2861 autonomously charges a 2 ~ 5 cell Li-Ion battery. The IC automatically detects the battery's state of charge and starts charging in the proper charge state. It completes full or partial charging cycles without host intervention. Note that when performing stand-alone charging, the IC's default CMI must match the battery requirements. This includes the number of cells being charged, their termination voltage, fastcharge current, precharge current, and shorted battery current. The CMI Options section shows the default settings for each available CMI option. Contact sales@active-semi.com for additional information about other configurations. Note that the WATCHDOG bits must be set to 00 to disable the watchdog timer in stand-alone charging mode.

Charger Enable / Disable

The ACT2861 can only enter Charge mode from HIZ mode. Note that if the IC is commanded to enter both OTG mode and Charge mode at the same time, OTG mode takes precedence. When in HIZ mode, the charger can be enabled with the EN_CHG pin or by I²C. To enable the charger with the EN_CHG pin, pull the pin above 0.8V. To disable the charger, pull it below 0.8V. EN_CHG connects to a comparator with a 0.8V threshold. The EN_CHG pin is 5V compliant, so it can be pulled up to 5V even when power is not applied to the IC. Connect a resistor divider to EN_CHG to set up a UVLO threshold to start charging. This is useful when the system should not start charging until the input voltage goes above a specific value.

The charger can also be enabled with the I²C bit OVERRIDE_EN_CHG bit in register 0x00h. Setting this bit = 1 overrides the EN_CHG pin and forces the IC into Charge mode. When this bit = 0, the EN_CHG pin is used to enter Charge mode. Figure 8 shows both the

hardware and I²C conditions required to enter Charge mode.

Note that in all cases, the I²C bit HIZ in register 0x00h must be = 0 to enter Charge mode. When the HIZ bit = 1, the IC is forced into HIZ mode and both OTG mode and Charge mode are disabled.

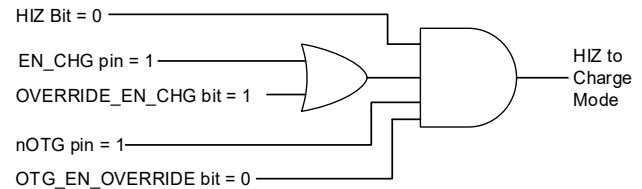

Figure 8: Conditions to Enter Charge Mode from HIZ Mode

After the IC is in Charge mode, the conditions to exit charge mode change. While in Charge mode, the nOTG pin and I²C bits cannot be used to exit Charge mode. When the charger is disabled, the IC state machine must go to HIZ mode or to SHIP mode. To disable the charger and go to HIZ mode, pull the EN_CHG pin low and set bit OVERRIDE_EN_CHG = 0. Setting bit HIZ = 1 overrides all other settings and disables the charger and puts the IC into HIZ mode. The IC must go to HIZ mode before going to OTG mode. The charger can also be disabled by putting the IC into SHIP mode.

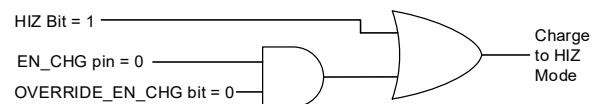

Figure 9: Conditions to Enter HIZ Mode from Charge Mode

Battery Charging Profile

The IC follows the standard Li-Ion battery charge profile with four charging phases: dead battery, preconditioning, constant current, and constant voltage. The battery charge current is a function the battery voltage and the IC's hardware and register settings. Table 3 shows these settings.

Table 3: Charging Current Setting

V _{BAT}	Charging Current	Current set by
< V _{BATDEAD}	I _{DBATTERY}	Fixed at 10mA
V _{BATDEAD} ~ V _{BATSHORT}	I _{SHORT}	I ² C Configurable: 1%, 2%, 4%, 8% of I _{OLIM} current
V _{BATSHORT} ~ V _{BAT_LOW}	I _{PRECHG}	I ² C Configurable: 5% to 20% of I _{OLIM} current
> V _{BAT_LOW}	I _{CHG}	I ² C and Hardware Configurable
> V _{TERM}	0A	None

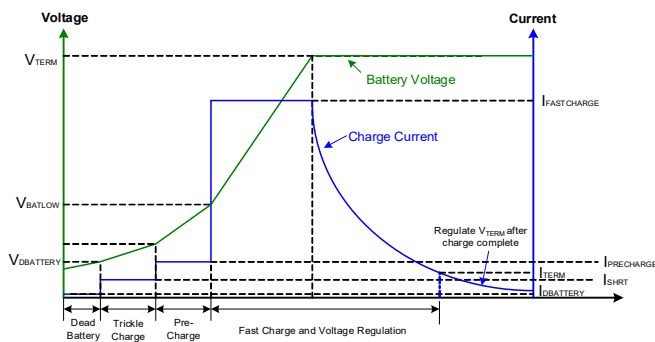

Figure 10: Battery Charging Profile

Setting Charge Current

The battery charging current, I_{CHG}, is set by a combination of a current sense resistor, an OLIM resistor, and a scaling factor defined by I²C bits IFCHG[6:0] in register 0x18h. The maximum allowable charge current is 5A. Figure 11 shows the hardware circuitry that sets I_{OLIM}. I_{OLIM} is the maximum charge current set by hardware. The actual battery charge current, I_{CHG}, can be scaled from 1% to 100% of I_{OLIM} in 1% steps. The following equation defines the final charge current.

$$I_{CHG} = I_{OLIM} * IFCHG[6:0]$$

Where I_{OLIM} is the hardware programmed charging current and IFCHG[6:0] is the scaling factor. IFCHG[6:0] is the decimal equivalent value in this register. For example, if I_{OLIM} is programmed to 4A and IFCHG[6:0] =

1001011b (75% decimal), the final charge current = 4A * 0.75 = 3A.

Note that IFCHG[6:0] is a 7 bit register and can be programmed between 0x00h and 0x7Fh (0% and 127%). If a value of 0x00h is written to the register, the register retains 0x00h, but the IC sets the charge current to 1%. If a value above 0x64h (100%) is written to the register, the IC retains the written value, but sets the charge current to 100%.

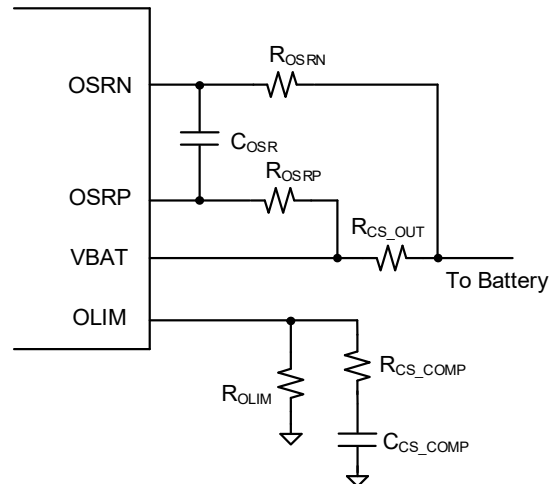

Figure 11: Charge Current Circuitry

The current sense resistor and OLIM resistor set the I_{OLIM} current.

$$I_{OLIM} = \frac{1000 \frac{V^2}{A}}{R_{OLIM} * R_{CS_OUT}}$$

Where R_{OLIM} is the resistor from the OLIM pin to AGND in ohms and R_{CS_OUT} is the current sense resistor value in ohms. The term 1000V²/A is a constant with the units volts²/Ampere.

The current sense resistor, R_{CS_OUT}, value should be chosen to give a maximum current sense voltage between 20mV and 50mV. 50mV is the absolute maximum allowable voltage. Using lower voltages reduces the resistor's power dissipation, but decreases accuracy. At lower charging currents, additional RC compensation must be placed in parallel with R_{OLIM}. Table 4 gives recommended resistor values for different values of I_{OLIM} current. Contact sales@active-semi.com for compensation information if other configurations are required.

Table 4: Charge Current Component Selection

Switching Frequency = 125kHz				
I _{OLIM} (A)	R _{CS} (mΩ)	R _{OLIM} (kΩ)	R _{CS_COMP} (kΩ)	C _{CS_COMP} (nF)
5	10	20	NA	NA
4	10	25	NA	NA
3	10	33	10	330
2	10	50	10	330
1.5	20	33	10	330
1	20	50	10	330
Switching Frequency = 250kHz, 500kHz, 1MHz				
I _{OLIM} (A)	R _{CS} (mΩ)	R _{OLIM} (kΩ)	R _{CS_COMP} (kΩ)	C _{CS_COMP} (nF)
5	10	20	NA	NA
4	10	25	NA	NA
3	10	33	NA	NA
2	10	50	15	56
1.5	20	33	10	100
1	20	50	10	100

To eliminate noise in the current measurement circuit, the current sense voltage must be filtered. The recommended values are R_{OSRP} = R_{OSRN} = 30.1ohm and C_{OSR} = 100nF. These values can be scaled up or down, but R_{OSRP} must be between 20ohm and 50ohm, and the resulting filter cutoff frequency must be between 20kHz and 30kHz.

The actual charge current can be measured with the OLIM pin. The OLIM voltage is directly proportional to the charging current. The following equation calculates the charging current.

$$I_{CHG} = I_{OLIM} \frac{V_{OLIM}}{2V}$$

Where I_{OLIM} is the hardware programmed 100% charging current in amps and V_{OLIM} is the voltage measured at the OLIM pin.

Note that the output current in charge mode becomes the input current in OTG mode.

Charging – Dead Battery, Short Circuit, and Precharge Currents

The charger operates at reduced currents when the battery voltage is low. This protects the battery chemistry and prepares it for fast charging. When in the SCOND_DB mode, the charger supplies a fixed 10mA of charge current.

When in the SCOND mode, the charger supplies the “short battery” current, I_{SHRT}. I_{SHRT} is a fixed percentage of I_{CHG} which is set by the I²C bits VBAT_SHORT_CURRENT in register 0x0Bh.

When in the PCOND mode (precharge), the charger supplies the “precharge” current, I_{PRECHG}. I_{PRECHG} is a fixed percentage of I_{CHG} which is set by the I²C bits IPRECHG in register 0x19h. IPRECHG can set the pre-charge current from 5% to 20% of the I_{CHG}.

Charging - Maximum Input Current Limit

In Charge mode, the IC features an input current limit circuit to meet maximum input current limitations for USB sources and to avoid over loading weak input voltage sources. Figure 12 shows that the input current limiting circuitry is identical to the charge current setting circuitry. When the input current reaches current limit, the ACT2861 control circuitry starts regulating the maximum input current. When in charge mode, this effectively lowers the charge current to maintain the maximum programmed input current. The maximum allowable input current is 5A. The actual input current limit, I_{IN_LIM} can be scaled from 1% to 100% of I_{LIM} in 1% steps. The following equation defines the final input current limit.

$$I_{IN_LIM} = I_{LIM} * INLIM[6:0]$$

Where I_{LIM} is the hardware programmed current limit and INLIM[6:0] is the scaling factor. INLIM[6:0] is the decimal equivalent value in this register. For example, if I_{LIM} is programmed to 5A and INLIM[6:0] = 0111100b (60% decimal), the final charge current = 5A * 0.60 = 3A.

Note that INLIM[6:0] is a 7 bit register and can be programmed between 0x00h and 0x7Fh (0% and 127%). If a value of 0x00h is written to the register, the register retains 0x00h, but the IC sets the input current to 1%. If a value above 0x64h (100%) is written to the register, the IC retains the written value, but sets the input current to 100%.

Input current limit can be set by the ILIM pin and IINLIM[6:0] registers.

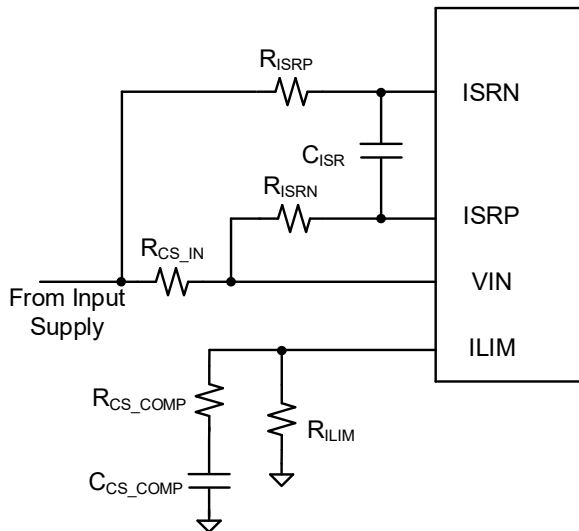

Figure 12: Input Current Circuitry

The current sense resistor and ILIM resistor set the I_{ILIM} current.

$$I_{ILIM} = \frac{1000 \frac{V^2}{A}}{R_{ILIM} * R_{CS_IN}}$$

Where R_{ILIM} is the resistor from the ILIM pin to AGND and R_{CS_IN} is the current sense resistor value in ohms. The term $1000V^2/A$ is a constant with the units volts²/Ampere.

The current sense resistor, R_{CS_IN} , has the same limitations as R_{CS_OUT} . At lower charging currents, additional RC compensation must be placed in parallel with R_{OLIM} . Table 4 is also valid for the input current limit circuitry.

The input current limit circuitry, $R_{ISRP} = R_{ISRN} = 30.1\text{ohm}$ and C_{ISR} also have the same input filter requirements as the charge circuitry.

If the system operates in input current limit mode, the INPUT_IINLIM_STATUS bit in register 0x03h goes high.

While the input current limit is active, both the Low Battery Safety Timer and Fast Charge Safety Timer run at a half speed to increase the overall safety timer timeout.

The actual input current can also be externally measured with the ILIM pin. The ILIM voltage is directly proportional to the charging current. The following equation calculates the actual input current.

$$I_{IN} = I_{ILIM} \frac{V_{ILIM}}{2V}$$

Where I_{ILIM} is the hardware programmed input current limit in amps and V_{ILIM} is the voltage measured at the ILIM pin.

Note that the input current in charge mode becomes the output current in OTG mode.

Charging – Minimum Input Voltage Limit

The input voltage limit feature is used to prevent the charger from overloading USB or weak input power sources. If the input voltage drops due to an overloaded input source, the ACT2861 starts regulating the minimum programmed input voltage to prevent the voltage from dropping farther. When in charge mode, this effectively lowers the charge current to maintain a minimum input voltage.

The minimum input voltage threshold is programmable between 4V and 16.7V in 100mV steps via I²C bits VINLIM[6:0] in register 0x16h. The following equation sets the minimum input voltage threshold.

$$VIN_{MIN} = 4.0V + 0.1V * VINLIM[6:0]$$

Where VINLIM[6:0] is the decimal equivalent of the value in this register. For example, to prevent a 12V input source from dropping below 9V, VINLIM[6:0] = 0110010b (50 decimal), the minimum input voltage = 4.0V + 0.1V * 50 = 9.0V.

If system is in input voltage limit, the INPUT_VINLIM_STATUS bit in register 0x03h goes high.

While the input voltage limit is active, both the Low Battery Safety Timer and Fast Charge Safety Timer run at a half speed to increase the overall safety timer timeout.

Battery Thermal Control

The ACT2861 TH pin can be used to monitor the battery temperature. An NTC resistor connected between TH and AGND provides temperature information. Battery temperature monitoring is valid in both Charge mode and OTG mode. If the battery temperature is outside the programmed upper and lower thresholds, the charger reports a fault and stops charging.

The ACT2861 provides two temperature monitoring algorithms. The first is the comprehensive industry standard JEITA compliance. The second is a simple I²C register based high and low temperature threshold. To enable either method, I²C bit DIS_TH in register 0x01h MUST be set to 0. If this bit is set to 1, the TH input is ignored. If thermal monitoring is not required, either connect a 10kΩ resistor between the TH pin and AGND or write a 1 into DIS_TH.

Figure 13 shows the TH pin internal circuitry. When thermal monitoring is enabled, the constant current source flows through the external NTC resistor, which gives a voltage vs temperature curve. The internal comparators give the ACT2861 information about the battery's operating temperature.

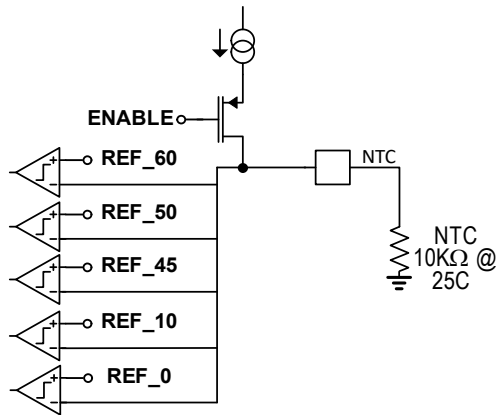

Figure 13: TH Pin Resistor Network

JEITA Battery Temperature Control

To improve the safety of charging Li-ion batteries, the JEITA guideline was released on April 20, 2007. The guideline emphasizes the importance of avoiding a high charge current and high charge voltage at both extreme low and high temperature ranges. To comply with JEITA battery charging requirements, and to improve battery reliability and safety, the ACT2861 reduces the termination voltage and/or the charging current when the battery is at temperature extremes. When the battery temperature is outside the normal charging range, IC either reduces the safety timer speeds or stops the timers until the temperature goes back into the normal charging range. When stopped, the timers are not reset. They hold their value and resume normal counting when charging restarts. Refer to the Safety Timer Speed Settings table for specific details.

The ACT2861 contains default JEITA voltage, current, and temperature limits. These voltage and current settings are configurable via I²C. The temperature limits

are fixed. To use the JEITA limits, enable thermal monitoring with bit DIS_TH = 0 and set I²C bit DIS_JEITA in register 0x1Ch = 0.

Mode T0 - T_{battery} < 0degC: All battery charging is suspended until the temperature goes back above 0deg C. Both the Fast Charge Safety Timer and the Low Battery Safety Timers are suspended. The T0 temperature is fixed at 0deg C and cannot be changed.

Mode T1-T2 – 0degC < T_{battery} < 10degC: Battery charging in this region is a function of the I²C bits JEITA_ISETC in register 0x1Ch. Depending on these register bits, fast charging in this region can range from fully suspended to not changed. Termination voltage is not changed. I_{SHORT} and I_{PRECHARGE} currents are not affected. Table 5 shows the resulting charge functionality and safety timer settings.

Mode T3-T5 – 45degC < T_{battery} < 60degC: Battery charging in this region is a function of the I²C bits JEITA_VSETH and JEITA_ISETH in register 0x1Ch. When JEITA_VSETH is a non-zero value, the IC reduces the termination voltage by 200mV to 750mV below the normal termination voltage. When JEITA_VSETH = 000 and JEITA_ISETH = 0, fast charge current is set to 50% of default. When JEITA_ISETH = 1, charging current and termination voltage are not changed. I_{SHORT} and I_{PRECHARGE} currents are not affected.

Mode T6 – T_{battery} > 60degC: All battery charging is suspended until the temperature goes back below 60deg C. Both the Fast Charge Safety Timer and the Low Battery Safety Timers are suspended. The T6 temperature is fixed at 60deg C and cannot be changed.

Table 5 shows the resulting charge functionality and safety timer settings. Figure 13 shows this in graphical form.

Table 5: JEITA Mode Charging Safety Timer Configuration

Mode	Temp	JEITA_ISETC [1:0]	JEITA_ISETH	JEITA_VSETH	Fast Charge Current	Fast Charge Safety Timer	PreCharge / Short Current	Low Battery Safety Timer
T0	<0C	XX	X	XXX	Suspended	Stopped	Suspended	Stopped
T1 to T2	0C to 10C	00	X	XXX	Suspended	Stopped	Suspended	Stopped
		01	X	XXX	25% of ICHG	½ Speed	I _{SHRT} / I _{PRECHG}	Full Speed
		10	X	XXX	50% of ICHG	½ Speed	I _{SHRT} / I _{PRECHG}	Full Speed
		11	X	XXX	100% of ICHG	Full Speed	I _{SHRT} / I _{PRECHG}	Full Speed
T3 to T5	45C to 60C	XX	X	NOT 000	Reduced Voltage	½ Speed	I _{SHRT} / I _{PRECHG}	Full Speed
		XX	1	000	Normal	Full Speed	I _{SHRT} / I _{PRECHG}	Full Speed
T3 to T5	45C to 60C	XX	0	000	50% of ICHG	½ Speed	I _{SHRT} / I _{PRECHG}	Full Speed
		XX	X	XXX	Suspended	Stopped	Suspend	Stopped

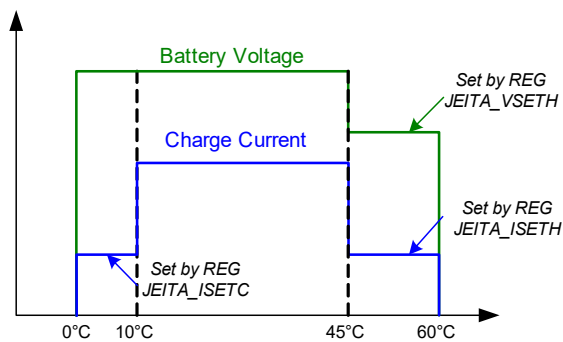
Figure 13: JEITA Charging Profile

Non-JEITA Battery Temperature Control

The ACT2861 also includes non-JEITA battery temperature control. Enable this mode by setting I²C bit DIS_JEITA in register 0x1Ch = 1. In this mode, the IC compares the battery voltage as measured on the TH pin to two internal I²C registers: OTG_HOT[1:0] and OTG_COLD, both in register 0x1D. If the temperature is higher than OTG_HOT[1:0], all charging is suspended and the safety timers are stopped. If the temperature is lower than OTG_COLD, all charging is suspended and the safety timers are stopped.

OTG_HOT[1:0] selects 55degC, 60degC, or 65degC. Set this register = 11 to disable shutdown at hot temperatures. The OTG_COLD register selects between 0degC and -10degC. It is not possible to automatically disable charging at low temperatures. However, a host processor can read the battery temperature via the ADC converter and manually disable charging.

Battery Path Impedance Compensation

The ACT2861 includes a Battery Path Impedance Compensation feature that speeds the charging cycle. This feature compensates for system level voltage drops due to PCB, connector, wiring resistances, and battery pack current sense resistances.

These voltage drops effectively reduce the voltage at the battery. This results in the charger reaching the constant voltage portion of the charge cycle too soon. Staying in constant current mode longer reduces the charging time.

The ACT286x allows the user to compensate for the system level resistances by increasing the voltage regulation set point according to a formula that is proportional to charging current and system resistance. This feature is implemented with two I²C registers: BAT_COMP_VCLAMP[2:0] and BAT_PATH_COMP[2:0] in register 0x0Ch. The BAT_COMP_VCLAMP[2:0] register sets the maximum increase in charging voltage. This can be programmed between 0mV and 420mV. The BAT_PATH_COMP[2:0] register sets the system resistance between 0mΩ and 140mΩ.

For safe operation, if one register is set to a non-zero value, the other register should also be set to a non-zero value. The maximum battery termination voltage is set by the lower of the following two equations.

$$V_{BAT_TERM} = V_{VTERM_I2C} + I_{CHG} * R_{BAT_PATH_COMP}$$

$$V_{BAT_TERM} = V_{VTERM_I2C} + V_{BAT_COMP_VCLAMP}$$

Where V_{BAT_TERM} is the new, compensated termination voltage in volts, V_{VTERM_I2C} is the I²C battery termination voltage programmed in registers 0x12h and 0x11h, I_{CHG}

is the actual charging current. $R_{BAT_PATH_COMP}$ is the programmed system impedance in ohms, and $V_{BAT_COMP_VCLAMP}$ is the maximum allowable increase in battery termination voltage.

Battery Full / Charging Termination

The ACT286x terminates a charge cycle when the battery reaches the termination voltage and the charge current drops below the termination current. If the Input current limit, Input Voltage limit, or Thermal Regulation loop is active, the charger will not enter the Charge Full or Charge Termination states.

Once the termination current and other requirements are met, the charger transitions from the fast charge state (FASTCHG) into either the charge full state (CHGFULL) or charge termination state (CHGTERM).

When $EN_TERM=0$, the charger enters the CHGFULL state. The Charge Full state functionality is the same as the FASTCHG state. The charger can stay in the CHGFULL state indefinitely. It keeps a fully charged battery regulated to the V_{BAT_REG} voltage. If something pulls current from the battery, the charger supplies current to maintain the battery voltage at V_{BAT_REG} . The maximum charge current is still limited by the external OLIM resistor and the IFCHG[6:0] register.

When $EN_TERM=1$, the charger enters the CHGTERM state. In this state, the charger is disabled and does not supply any current to the battery. It monitors the battery voltage to check for the condition when the battery voltage drops below $V_{TERM-VRECHARGE}$. The VRECHARGE voltage is typically 100mV or 150mV per cell. Once the battery voltage drops below the threshold, the IC enters the Fast Charge state and recharges the battery.

See the state machine for more details charging and charge termination.

Charging Safety Timers

The ACT2861 provides two internal charging safety timers: Low Battery Safety Timer and Fast Charge Safety Timer

When the Battery Voltage is below V_{BAT_LOW} and in the charger is in the SCOND or PCOND states, a fixed 120 minute Low Battery Safety Timer is implemented. During this time, the Fast Charge Safety Timer is held in

reset and not active. If the Low Battery Safety timer times out, the IC goes to the Charging Fault state until it is reset – See below on how to clear the Low Battery Safety Timer.

The Low Battery Safety Timer stops if the battery temperature causes the converter to stop switching and enter the SCSUSPEND or PCSUSPEND states. The Low Battery Safety Timer runs at ½ speed if the Input Voltage, Input Current, or Die Temperature regulations loops become active. This increases the overall time of 120 minute timer.

When the Battery Voltage is above V_{BAT_LOW} the Fast Charge Safety Timer is enabled and the Low Battery Safety timer is held in reset. The Fast Charge Safety Timer is controlled with the I²C bits FC_SAFETY_TIMER[4:0] in register 0x1Bh. It is configurable between 30 minutes and 16 hours. If the Fast Charge safety timer expires, the IC goes into the Charging Fault state and charging is disabled until the Fast Charge Safety Timer is reset.

Both the Low Battery Safety and Fast Charge Safety Timers can be fully disabled and reset via the I²C bit DIS_SAFETY_TIMER in register 0x1Bh or manually suspended using the I²C bit SUSPEND_SAFETY_TIMER in register 0x1Bh.

Both safety timers are automatically stopped any time the charging is enabled but charging has suspended. This occurs when the battery temperature exceeds the allowable temperature limits.

Both safety timers also run at ½ speed when VIN Input Regulation, IIN Current Regulation, or Die Thermal Regulation are active to increase the overall safety timer windows.

Additionally, the Fast Charge Safety Timer runs at ½ speed in some JEITA charging modes. See the JEITA Battery Temperature Control paragraph for more details.

Both safety timers are reset when any of the following occur:

1. Charging State Machine enters RESET state
2. DIS_SAFETY_TIMER register is set High
3. Charging has completed. This includes entering either the CHGFULL or CHG TERM states.
4. IC exits the Charge Mode via the EN_CHG pin, OVERRIDE_EN_CHG, HIZ Registers, etc.

Table 6: Fast Charge Safety Timer Response

Condition	Charge Response	Fast Charge Safety Timer Speed
Normal Fast Charge	NONE	Full Speed
VIN Input Regulation	Reduced Charge Current	½ Speed
IIN Input Current Regulation	Reduced Charge Current	½ Speed
Thermal Die Regulation	Reduced Charge Current	½ Speed
Battery Temp Exceed Limits	Suspend Charge	Suspend
Battery Temp Hot or Cold	Reduced Charge Current or VTERM	½ Speed

Table 7: Low Battery Safety Timer Response

Condition	Charge Response	Low Battery Safety Timer Speed
Normal SCOND or PCOND Charge	NONE	Full Speed
VIN Input Regulation	Reduced Charge Current	½ Speed
IIN Input Current Regulation	Reduced Charge Current	½ Speed
Thermal Die Regulation	Reduced Charge Current	½ Speed
Battery Temp Exceeds JEITA T0 or T6 Limits	Suspend Charge	Suspend
Battery Temp Exceeds JEITA T1-T2 or T3-T5 Limits	NONE	Full Speed

Safety Timer Configuration Change

When the safety timer value needs to be changed, it is recommended that the timer is first disabled. Then change the FC_SAFETY_TIMER[4:0] register. Disable the safety timer by writing a 1 into I²C bit DIS_SAFETY_TIMER in register 0x1Bh. This procedure ensures the safety timer properly restarts after new value is configured.

Charger – Input Capacitor Selection

Note that the Charger CIN capacitors are also the OTG output capacitors. They are connected to VIN. The input capacitance should be a combination of ceramic and bulk capacitance.

If the design only uses Charge mode and does not use OTG mode, 22uF to 47uF capacitors are typically acceptable, but the final value is application dependent. Choose the input capacitor value to keep the input voltage ripple less than ~50mV. The input capacitance can be increased without limit.

$$C_{CHG_IN} = I_{CHG} * \frac{\frac{V_{BAT}}{V_{IN}} * \left(1 - \frac{V_{BAT}}{V_{IN}}\right)}{F_{SW} * V_{ripple}}$$

Where C_{CHG_IN} is the charging input capacitance (OTG output capacitance) in uF, I_{CHG} is the charging current in Amperes, V_{BAT} is the battery voltage in volts, V_{IN} is the input voltage in volts, F_{SW} is the switching frequency in Hz, and V_{ripple} is the maximum input voltage ripple in volts.

An additional 100uF bulk electrolytic capacitor is recommended.

If the design uses OTG Mode, refer to the OTG Output Capacitor Selection. The OTG Mode capacitor requirements take precedence over Charging input capacitance.

Be sure to consider the input capacitor's DC bias effects. A capacitor's actual capacitance is strongly affected by its DC bias characteristics. The input capacitor is typically an X5R, X7R, or similar dielectric. Use of Y5U, Z5U, or similar dielectrics is not recommended.

Input capacitor placement is critical for proper operation. The input ceramic capacitor must be placed as close to the IC as possible. The traces from VIN to the capacitor and from the capacitor to PGND should as short and wide as possible. Refer to the Layout Guidelines selection and to the EVK layout for details.

The bulk capacitor should be placed on the left side of the current sense resistor.

Charger – Output Capacitor Selection

Note that the Charger C_{OUT} capacitor is also the OTG input capacitor. It is connected directly to V_{BAT} pin. The capacitor should be dedicated high quality, low-ESR, ceramic capacitor that is optimally placed to minimize the power routing. 22uF to 47uF capacitors are typically acceptable, but the final value is application dependent. Choose the output capacitor value to keep the charger output voltage ripple less than ~50-100mV. The output capacitor can be increased without limit.

$$C_{\text{CHG_OUT}} = I_{\text{CHG}} * \frac{V_{\text{BAT}} * \left(1 - \frac{V_{\text{BAT}}}{V_{\text{IN}}}\right)}{F_{\text{SW}} * V_{\text{ripple}}}$$

Where C_{CHG_OUT} is the charging output capacitance in uF, I_{CHG} is the charging current in Amperes, V_{BAT} is the battery voltage in volts, V_{IN} is the input voltage in volts, F_{SW} is the switching frequency in Hz, and V_{ripple} is the maximum output voltage ripple in volts.

The ceramic capacitor PCB placement is critical. Refer to the Layout Guidelines selection and to the EVK layout for details.

Be sure to consider the input capacitor's DC bias effects. A capacitor's actual capacitance is strongly affected by its DC bias characteristics. The output capacitor is typically an X5R, X7R, or similar dielectric. Use of Y5U, Z5U, or similar dielectrics is not recommended. Output capacitor placement is critical for proper operation. The output capacitor must be placed as close to the IC as possible. The traces from V_{BAT} to the capacitor and from the capacitor to PGND should as short and wide as possible.

The bulk capacitor should be placed on the right side of the current sense resistor.

OTG MODE

The ACT2861 supports on-the-go, OTG, mode buck-boost converter operation. In this mode, the IC delivers power from the battery to power other portable devices.

OTG Enable / Disable

The ACT2861 can only enter OTG mode from HIZ mode. Note that if the IC is commanded to enter both OTG mode and Charge mode at the same time, OTG mode takes precedence. When in HIZ mode, OTG mode can be enabled by the nOTG pin or I²C. In either case, the I²C bit EN_OTG in register 0x0Eh must be = 1 to enable OTG mode. Then pull the nOTG pin low to enter OTG mode.

OTG Mode can also be enabled with the I²C bits OTG_EN and OTG_EN_OVERRIDE in register 0x0Eh. Setting OTG_EN = 1 enables OTG mode. Then set OTG_EN_OVERRIDE = 1 to enter OTG mode. Note that the OTG_EN_OVERRIDE bit overrides the nOTG pin. Figure 14 shows both the hardware and I²C conditions required to enter OTG mode.

Note that in all cases, the I²C bit HIZ in register 0x00h must be = 0 to enter OTG mode. When HIZ = 1, the IC is forced into HIZ mode and both OTG mode and Charge mode are disabled.

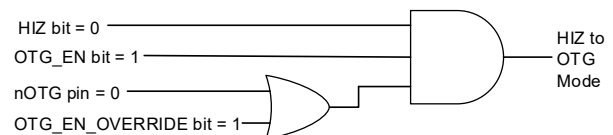

Figure 14: Conditions to Enter OTG Mode from HIZ Mode

After the IC is in OTG mode, the conditions to exit OTG mode change. When OTG mode is disabled, the IC state machine must go to HIZ mode or to SHIP mode. There are several ways to disable OTG mode and go to HIZ mode.

1. Set the I²C HIZ bit = 1
2. Set the I²C OTG_EN bit = 0
3. Pull the nOTG pin high and set the I²C OTG_EN_OVERRIDE bit = 0.
4. The IC also exits OTG mode if there is an OTG overvoltage condition for longer than 100ms.

OTG mode can also be disabled by putting the IC into SHIP mode.

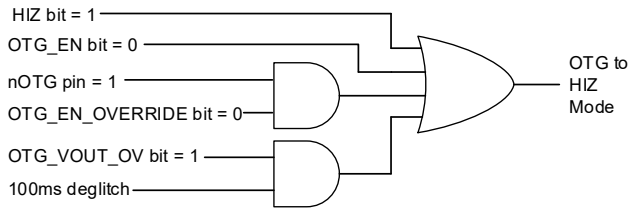

Figure 15: Conditions to Enter HIZ Mode from OTG Mode

OTG Output Voltage Setting

The OTG output voltage is programmable between 2.96V and 23.42V in 20mV steps via by I²C bits OTG_VOUT[9:0] in registers 0x13h and 0x14h.

$$V_{OTG} = 2.96V + 20mV * OTG_VOUT[9:0]$$

Where VOTG_VOUT[9:0] is the decimal equivalent of the value in this register. For example, if OTG_VOUT[9:0] = 0111000100b (452 decimal), the output voltage = 2.96V + 0.02V * 452 = 12.00V.

When changing from one OTG output voltage to another, the slew rate is programmable between 1V/ms and 0.1V/ms by I²C bits OTG_OUTPUT_SLEW[1:0] in register 0x10h. This allows the output to conform to QC2.0/QC3.0/USB PD functions for higher output voltages.

The battery voltage must always stay above the minimum allowable battery voltage set by I²C bits VBAT_LOW[6:0] in register 0x1Ah and OTG_VBAT_CUTOFF[2:0] in register 0x0Fh. The actual voltage is the VBAT_LOW voltage minus the OTG_VBAT_CUTOFF voltage. If the battery voltage drops below this value, the IC turns off the OTG output and goes to the OTG_RST state.

OTG Active Discharge

When changing the OTG output voltage to a higher level, the switcher ramps the output voltage by the programmed slew rate. When the output voltage is programmed from a higher to a lower voltage, the voltage drops at a rate determined by the output capacitance and the load current. To minimize the fall time in no-load conditions, the ACT2861 can provide a 70mA sink when the output is transitioning to a lower output voltage. Enable this feature by writing 1 into I²C bit OTG_PULLDOWN_RAMP. The 70mA load turns on until the output voltage goes into regulation.

OTG Enable Delay

Once the OTG has the valid conditions for startup, the OTG Enable Delay timer is enabled. The timer options

allow a 0ms to 1s delay. The OTG startup delay is controlled by the I²C bits OTG_EN_DLY[1:0]

OTG Mode Soft Start

After the OTG Enable Delay has completed, the IC starts the output using a soft start function programmable by the I²C bits OTG_SS in register 0x0Eh. The softstart time is independent of the output voltage setting.

OTG Mode Constant Output Current Regulation

After OTG mode soft start has completed, the IC monitors the current on VIN input side sense resistor (ISRP and ISRN) to provide constant current protection and regulation in OTG mode. When the OTG output current exceeds programmed value set by the ILIM pin and the OTG_CC register, the switching converter changes to output constant current mode and regulates a fixed output current. In this case, the output voltage may drop if the load resistance continues to decrease.

The maximum OTG output current is set by the same resistor as the charger input current, R_{CS_IN}. R_{CS_IN} must be set for the larger of the charge current or OTG current. The maximum allowable OTG output current is 5A. The actual output current limit, I_{OTG_OUT_LIM} can be scaled between 1% to 100% of I_{LIM} in 1% steps. The following equation defines the final OTG output current limit.

$$I_{OTG_OUT_LIM} = I_{LIM} * OTG_CC[6:0]$$

Where I_{LIM} is the hardware programmed current limit (see the **Charging – Maximum Input Current** section for details) and OTG_CC[6:0] is the scaling factor. OTG_CC[6:0] is the decimal equivalent value in this register. For example, if I_{LIM} is programmed to 5A and OTG_CC[6:0] = 0111100b (60% decimal), the final charge current = 5A * 0.60 = 3A.

Note that OTG_CC[6:0] is a 7 bit register and can be programmed between 0x00h and 0x7Fh (0% and 127%). If a value of 0x00h is written to the register, the register retains 0x00h, but the IC sets the OTG scaling factor to 1%. If a value above 0x64h (100%) is written to the register, the IC retains the value, but sets the scaling factor to 100%

The OTG regulation mode can be monitored in real time by I²C bit OTG_Output_CC in register 0x20h. When this bit = 0, the IC is regulating in output constant voltage mode. When this bit = 1, the IC is regulating in constant current mode. If the output drops below 3V, the IC assumes an output fault has occurred and disables the output for 3s. This is the OTG_HICCUP state. After 3s, the state machine goes to OTG_RST and restarts. If a

short or high current fault is present after the restart, the IC cycles back to OTG_HICCUP and OTG_RST. This cycle continues indefinitely until OTG is disabled or the fault is removed.

OTG Mode Constant Input Current Regulation

At all times during OTG mode, the IC monitors the current on VBAT output side sense resistor (OSRP and OSRN) to provide battery current protection.

The maximum OTG input current is set by the same resistor as the charger output current, R_{CS_OUT} . Unlike the R_{CS_IN} resistor, R_{CS_OUT} does not have to be set to the larger of the charge current or OTG input current. The maximum allowable OTG input current is 5A. The maximum OTG input current limit, $I_{OTG_IN_LIM}$, is a scaled version of the programmed charge current, I_{CHG} . $I_{OTG_IN_LIM}$ is scaled to 150% or 200% of I_{CHG} . This allows a larger battery discharge current than charge current. The I²C bits OTG_BAT_ILIM[1:0] in register 0x10h scale the current. See the **Setting Charge Current** section for details on programming I_{CHG} .

Table 8: OTG I²C Input Current Limit Setting

OTG_BAT_ILIM[1:0] Register Setting	OTG Input Current
00	OTG Disabled
01	150% of I_{CHG}
10	200% of I_{CHG}
11	300% of I_{CHG}

When the OTG output current exceeds the maximum programmed value, the switching converter changes to input constant current mode and regulates a fixed input current. The OTG regulation mode can be monitored in real time by I²C bit OTG_BATTERY_CC in register 0x20h. When this bit = 0, the IC is not in OTG constant current mode. When this bit = 1, the IC is regulating in input constant current mode. If the output drops below 3V, the IC assumes an output fault has occurred and disables the output for 3s. It follows the same flow as an output current fault.

OTG Mode VIN Over-Voltage Protection

When in OTG mode, the IC provides power out of the IC's input. An input voltage should not be applied during OTG Mode. To detect a possible plug in of a higher supply on VIN during OTG mode, the IC detects an over-voltage condition on VIN (OTG output) and immediately stops switching. The OTG overvoltage threshold is fixed at 108% of the programmed OTG voltage. If the OV

condition lasts for more than 100ms, the IC exits OTG Mode and enters HIZ Mode.

OTG – Cord Compensation

ACT286x provides cord compensation at the OTG output. This feature compensates for system level voltage drops due to PCB, connector, and wiring resistances. These resistances reduce the output voltage at the load.

The ACT286x features Cord Compensation which allows the user to compensate for these system level resistances by increasing the OTG voltage regulation set point proportional to the OTG output current. The output voltage increases linearly with increasing load current. The I²C OTG_CORD_COMP[1:0] bits in register 0x0F set the Cord Comp value.

The Cord Compensation value is normalized to $R_{CS_IN} = 10m\Omega$ and a 2.4A OTG load current. It scales linearly with changes in current sense resistance or load current. Note that the R_{CS_IN} resistor is both the charging input current limit resistor and the OTG output current limit resistor.

$$V_{Cord_Comp} = V_{OTG_CORD_COMP} * \frac{I_{OTG}}{2.4A} * \frac{R_{CS_IN}}{0.01\Omega}$$

Where $V_{OTG_CORD_COMP}$ is the I²C Cord Compensation value of 100mV, 200mV, or 300mV per Table 9, I_{OTG} is the actual OTG output current in Amperes, and R_{CS_IN} is the current sense value in Ohms.

Table 9: OTG Cord Comp Setting

OTG_CORD_COMP[1:0] Setting	Cord Comp Value	Equivalent System Resistance
00	0 (Disabled)	0m Ω
01	100mV	41.7m Ω
10	200mV	83.3m Ω
11	300mV	125.0m Ω

Light Load Disable

The ACT2861 includes a Light Load Disable function in OTG mode. This function disables OTG mode and puts the IC into HIZ mode when the load drops very low. This condition typically happens when the ACT2861 OTG output is charging a portable device. When the portable device is fully charged, the output current drops to 0A. Light Load Disable minimizes battery current consumption and extends battery life when the OTG output is not needed.

Light Load Disable is available when the IC is operating in OTG mode, the switcher is operating in buck mode, VBAT is higher than VIN by a minimum of 0.5V, and the OTG Output Voltage is less than 6V. Enable Light Load Disable by setting I²C bit OTG_OFF_LOAD_EN in register 0x0Eh = 1. Setting this bit = 0 disables the feature. The minimum current is set to 5mA typical. The current must be low for longer than the time set in I²C bit OTG_OFF_DLY[1:0]. This time can be programmed to 10s, 20s, or 30s.

Once the OTG state machine has detected a light load condition, it enters the OTG_LL_DIS state. The IC must exit OTG mode and re-enter OTG mode to restart the converter. This is typically accomplished by toggling the nOTG pin, but can also be accomplished via I²C.

OTG – Output Voltage DVS

The ACT2861 is ideally suited for many industry standard charging protocols such as USB PD3.0, QC2.0, QC3.0, etc. This includes USB PD3.0 + PPD. To achieve this compatibility, the output voltage can be dynamically changed in OTG mode. VOUT in OTG mode can be dynamically changed by writing to the OTG_VOUT[10:0] register, if internal feedback is used and OTG_VOUT_I2C is set to 0. The OTG_OUTPUT_SLEW[1:0] register is used to control the slew rate between settings when the OTG_VOUT[10:0] is changed. When the voltage is increased, the internal ramp and regulator can compensate and increase the voltage. However, when the voltage is decreased, and there is no external load on the output, the output voltage may not decrease fast enough to meet the requirements. To speed up the transition time from higher to lower output voltages, set OTG_PULLDOWN_RAMP=1. This turns on an internal 70mA load when the output voltage is stepped to a lower voltage using the OTG_VOUT[10:0] register. The 70mA load turns off when the voltage goes into regulation.

The ACT2861 also has a pulldown current that goes active during any output overvoltage condition. Enable this feature by setting the I²C bit OTG_PULLDOWN_OV = 1.

OTG Mode – State Machine Status

The I²C bits OTG_STATUS[2:0] in register 0x20h provide the user with real time status of the OTG state machine. These bits are always 000 when the IC is not in OTG mode.

Table 10: OTG Cord Comp Setting

OTG_STATUS[2:0]	State Machine State
000	OTG_RST
001	OTG_SS
010	OTG_REG
011	OTG_HICCUP
100	OTG_LL_DIS
101-111	Not Valid

OTG – Battery Temperature Protection

The ACT2861 provides battery temperature in OTG mode. If the battery temperature goes outside the programmed range, the IC goes to the OTG_RST state. It stays there until the temperature returns inside the programmed range or battery temperature monitoring is disabled. Note that the OTG thermal limits use the same registers as the non-JEITA charging registers.

Enable OTG battery temperature monitoring by setting I²C bit DIS_TH = 0. When this feature is enabled, the IC compares the battery voltage as measured on the TH pin to two internal I²C registers: OTG_HOT[1:0] and OTG_COLD, both in register 0x1Dh.

OTG - Frequency

The ACT2861 OTG switching frequency is the same as the charging switching frequency. The ACT2861 can operate at 125kHz, 250kHz, 500kHz, or 1MHz. The switching frequency is set by the factory and is not user programmable. The default frequency is 500kHz to give the best tradeoff between size and efficiency, but can be programmed to the other options with a custom CMI. Note that the external component value requirements change with different switching frequencies. Contact sales@active-semi.com for additional information about other configurations.

OTG – Input Capacitor Selection

Note that the OTG CIN capacitor is also the charging output capacitor. It is connected directly to VBAT pin. The capacitor should be dedicated high quality, low-ESR, ceramic capacitor that is optimally placed to minimize the power routing. 22uF to 47uF capacitors are typically acceptable, but the final value is application dependent. Choose the input capacitor value to keep the OTG input voltage ripple less than ~50mV. The COTG input capacitor can be increased without limit.

$$C_{OTG_IN} = I_{OTG} * \frac{V_{OTG} * \left(1 - \frac{V_{OTG}}{V_{IN}}\right)}{F_{SW} * V_{ripple}} \quad \text{Equation 6}$$

Where C_{OTG_IN} is the OTG input capacitance (Charging output capacitance) in uF, I_{OTG} is the OTG output current in Amperes, V_{OTG} is the OTG output voltage in volts, V_{IN} is the OTG input voltage in volts, F_{SW} is the switching frequency in Hz, and V_{ripple} is the maximum allowable OTG input voltage ripple in volts.

If the OTG input source is a battery, no additional capacitance is needed. If the OTG input source is a power supply rail, adding an additional 100uF bulk electrolytic capacitor is recommended.

The ceramic capacitor PCB placement is critical. Refer to the Layout Guidelines selection and to the EVK layout for details.

Be sure to consider the input capacitor's DC bias effects. A capacitor's actual capacitance is strongly affected by its DC bias characteristics. The input capacitor is typically an X5R, X7R, or similar dielectric. Use of Y5U, Z5U, or similar dielectrics is not recommended. Input capacitor placement is critical for proper operation. The input capacitor must be placed as close to the IC as possible. The traces from VBAT to the capacitor and from the capacitor to PGND should as short and wide as possible.

OTG – Output Capacitor Selection

Note that the OTG COUT capacitors are also the charging input capacitors. They are connected to VIN. The output capacitance must be a combination of ceramic and bulk capacitance.

Table 11 gives the required capacitor values for stability. Note that the table has two output capacitor options: Standard Capacitance and Minimum Capacitance. The Standard Capacitance design requires more overall capacitance, but places no restriction on the bulk capacitor ESR. The Minimum Capacitance design results in an overall smaller design, but places restrictions on the ESR. The capacitor values can be increased without limit.

Note that the Ceramic and Bulk capacitor values are recommended “Capacitor Values”. When choosing the ceramic capacitors, use X5R or X7R dielectrics and be sure to consider the capacitor's tolerance and DC bias effects. Use of Y5U, Z5U, or similar dielectrics is not recommended. The 22uF capacitor must have at least 9uF of effective capacitance for stability. The 47uF capacitor must have 19uF of capacitance. The bulk capacitors do not have DC bias effects.

Output ceramic capacitor placement is critical for proper operation. The output capacitor must be placed as close to the IC as possible. The traces from VIN to the capacitor and from the capacitor to PGND should as short and wide as possible. The bulk capacitor should be placed to the left of the current sense resistor. Refer to the Layout Guidelines selection and to the EVK layout for additional details.

OTG - Inductor Selection

The buck-boost regulator utilizes current-mode control and a proprietary compensation scheme to simultaneously compensate the buck, buck-boost, and boost modes of operation. The ACT2861 compensation requires a fixed inductor value that is matched to the switching frequency. Table 9 gives the required inductor value. Choose an inductor with a low DC-resistance, and avoid inductor saturation by choosing inductors with DC ratings that exceed the maximum output current by at least 30%. The inductor value must be within +30% to -30% across all operating conditions.

OTG - Compensation

The ACT2861 operates in three switching modes: buck, buck-boost, and boost mode depending on the input and output voltage ratios. The IC contains a proprietary compensation scheme to simultaneously compensate all three switching modes. The compensation values are directly tied to the switching frequency and required inductor value. Table 9 provides the required compensation values. Figure 16 shows the OTG compensation components.

Table 11: OTG Inductor and Compensation

Switching Frequency	Inductor Min / Typ / Max (uH)	C _{ICOMP1} (nF)	C _{ICOMP2} (nF)	R _{ICOMP} (kΩ)	Standard Capacitance Design			Minimum Capacitance Design		
					Ceramic Capacitor (uF)	Bulk Capacitor (uF)	Bulk Capacitor ESR (mΩ)	Ceramic Capacitor (uF)	Bulk Capacitor (uF)	Bulk Capacitor ESR (mΩ)
125Khz	29 / 42 / 55	82	8.2	20.0	47	1000	N/A	22	470	30 - 100
250Khz	15 / 22 / 29	39	3.9	20.0	47	470	N/A	22	220	50 - 200
500KHz	7 / 10 / 13	22	2.2	20.0	47	220	N/A	22	100	50 - 200
1MHZ	4 / 5.6 / 7.28	10	1.0	20.0	47	100	N/A	22	100	50 - 200

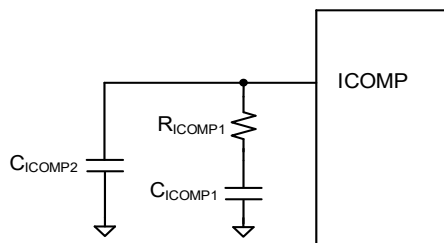
Figure 16: OTG Compensation
Table 13: nCHG Pin State in OTG Mode

OTG State	nCHG Output Pin
OTG Enabled and Output Valid	LOW
OTG Disabled	HIZ
OTG Enabled In Fault, Hiccup, or Light Load states	HIZ

CHARGE STATUS OUTPUT PIN (NCHG)

The ACT2861 indicates the Charging and OTG states on the open drain nCHG pin. The nCHG pin typically drives an LED, but can also be monitored by a micro-processor GPIO. In Charge mode, the nCHG pin function is enabled by setting I²C bit DIS_nCHG_CHG in register 0x00h = 0. Disable the function by setting it to 1. In OTG mode, the nCHG function is enabled by setting the I²C bit EN_OTG_nCHG in register 0x0Fh = 1. Disable the function by setting it to 0.

Tables 12 and 13 show the nCHG state in different Charge and OTG operating conditions.

Table 12: nCHG Pin State in Charge Mode

Charging State	nCHG Output Pin
Charging in progress	LOW
Charging complete	HIZ
Charge suspend or Fault	Blinking at 1Hz

ADC Monitoring

General Description

The ACT2861 contains a built-in analog to digital converter, ADC, which can be used to monitor seven system level parameters. These include input voltage, output voltage, input current, output current, TH pin, die temperature, and the external ADC input pin. It uses a single 12 bit delta-sigma ADC that uses an analog input multiplexer to select one of seven channels for the A/D conversion. The resulting digital results are stored in seven digital registers. A seven to one multiplexer connects one of the ADC output registers to the user accessible register map.

ADC Configuration

The ACT2861 ADC is configured through the I²C interface. It is enabled and disabled by the I²C bit EN_ADC in register 0x09h. The ADC has two conversion modes, manual single-shot conversion and automatic polling conversion.

Single-Shot Conversion

Configure the IC for single-shot conversion mode by setting the following I²C bits in register 0x09h

ADC_ONE_SHOT = 1.

ADC_CH_SCAN = 0

DIS_ADCBUF = 0

In single shot mode, the user defines the input channel to be converted and then manually initiates the ADC conversion. I²C bits ADC_CH_CONV [2:0] in register 0x0Ah select the input channel to be converted. ADC_CH_READ [2:0] selects the ADC channel to be read. These should be set to the same channel. The user initiates an ADC read by writing a 1 into EN_ADC in register 0x09h. When ADC conversion is complete, the ADC_DATA_READY bit in register 0x0Ah is set to 1, nIRQ is asserted low, and EN_ADC bit automatically changes back to 0. The uP can then read the status bits to find that the ADC conversion is complete. The ADC data are stored in ADC_OUT [13:6] in register 0x07h and ADC_OUT[5:2] in register 0x08h. nIRQ stays asserted low and the ADC_READY_BIT stays equal to 1 until the ADC data is read. Reading the ADC data automatically deasserts nIRQ. To initiate another ADC conversion for the same channel, set EN_ADC=1. To initiate an ADC conversion for another channel, change ADC_CH_CONV and ADC_CH_READ to the appropriate channel and then set EN_ADC=1.

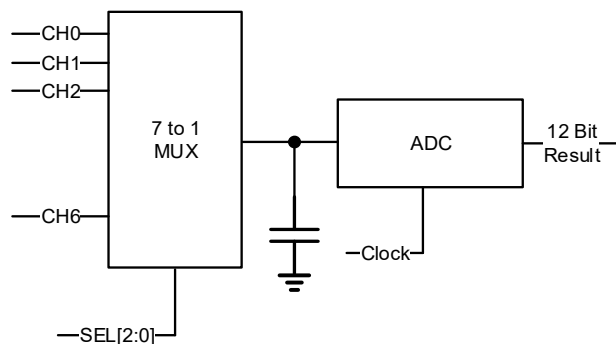

Figure 17: ADC Block Diagram

Automatic Polling Conversion

Configure the IC for automatic polling conversion mode by setting the following I²C bits in register 0x09h

ADC_ONE_SHOT = 0

ADC_CH_SCAN = 1

DIS_ADCBUF = 0

Start the automatic polling by changing EN_ADC to 1. When in automatic polling mode, the ADC continuously changes the MUX inputs to read all input channels. The ADC continually overwrites the data in the output register. After all channels have been converted, the ADC_DATA_READY bit is set to 1. Note that nIRQ is not asserted low in Automatic Polling mode. Ensure that ADC data is valid and ready by reading the ADC_DATA_READY before reading ADC data. After the ADC_DATA_READY bit is set to 1, the user defines the channel to be read with the ADC_CH_READ [2:0] bits in register 0x0Ah. Change ADC_CH_READ to read additional channels.

Table 14 shows the equations to convert the ADC data into the actual measured values. Note that the table refers to the voltages and currents with respect to Charge mode.

Note that the **klim** term in the Output Current measurement depends on IC's operating mode and the OTG_BAT_ILIM register setting (I²C register 0x10h). Table 15 shows how to determine the correct klim value.

Table 14: ADC Channels

Channel	Channel Description	ADC_CH_CONV[2:0]	ADC_CH_READ[2:0]	Value
CH0	Input Current (I_{IN})	000	000	$I_{IN} = 0.7633 * (ADC_OUT[13:2] - 2048) / R_{CS_IN} / R_{ILIM}$
CH1	Input Voltage (V_{IN})	001	001	$V_{IN} = 0.02035 * (ADC_OUT[13:2] - 2048)$
CH2	Output Voltage (V_{BAT})	010	010	$V_{BAT} = 0.01527 * (ADC_OUT[13:2] - 2048)$
CH3	Output Current (I_{BAT})	011	011	$I_{BAT} = klim * 0.7633 * (ADC_OUT[13:2] - 2048) / R_{CS_OUT} / R_{OLIM}$
CH4	TH	100	100	$V_{TH} = 0.003053 * (ADC_OUT[13:2] - 2048)$
CH5	Die Temperature	101	101	$T_J = 0.2707 * ADC_OUT[13:2] - 809.49$
CH6	ADC Input	110	110	$V_{ADC} = 0.01527 * (ADC_OUT[13:2] - 2048)$

Table 15: klim Values

IC Operating Mode	OTG_BAT_ILIM (register 0x10h)	klim
Charge	n/a	1
OTG	00	disabled
	01	1.5
	10	2.0
	11	1.5

Below are two example ADC reads.

1. Charge mode. Battery voltage = 7.4V

Read CH2 to measure the battery voltage. This reading results in the ADC_OUT[13:2] bits = 0x9E9h, which converts to 2537 decimal.

$$V_{BAT} = 0.01527 * (2537 - 2048) = 7.04V$$

2. OTG mode. OTG input current (from the battery) = 2.0A. Assume $R_{CS_OUT} = 0.01\text{ohm}$ and $R_{OLIM} = 33.1\text{kohm}$. Also assume the OTG_BAT_ILIM register = 10

Read CH3 to measure the battery current. This reading results in the ADC_OUT[13:2] = 0x9A4h, which converts to 2468 decimal.

$$I_{BAT} = \frac{klim * 0.7633 * (2468 - 2048)}{0.01 * 33100} = 1.937A$$

PC board layout guidance

Proper parts placement and PCB layout are critical to the operation of switching power supplies. Follow the following layout guidelines when designing the ACT2861 PCB. Refer to the Active-Semi ACT2861 Evaluation Kit for layout guidance.

1. Place the ceramic input and output capacitors as close as possible to the IC. Connect the input capacitors directly between VIN and PGND pins on the top layer. Connect the output capacitors directly between VBAT and PGND pins on the top layer. Use 1206 sized capacitors to allow for proper switch pin routing. Note that the input and output capacitor placement is critical. Active-Semi strongly recommends following the EVK input capacitor and output capacitor placement and routing. The bulk input and output capacitor placement is not as critical. Bulk capacitors should be placed on the opposite side of the sense resistors from the ceramic capacitors.
2. Minimize the switch node trace lengths between the SW1 and SW2 pins and the inductor. Optimal switch node routing is to run the traces between the input and output capacitors' pads. Using 1206 or larger sized capacitors is recommended. Avoid routing sensitive analog signals near these high frequency, high dV/dt traces. Active-Semi strongly recommends following the EVK inductor placement and PCB routing.
3. The VBATS pin should be Kelvin connected to the battery. Keep this trace away from the SW1 and SW2 traces to prevent noise injection. The IC regulates the battery voltage to this Kelvin connection.
4. The PGND and AGND ground pins must be electrically connected together. The AGND ground plane should be isolated from the rest of the PCB power ground. These two ground

pins should be connected together right at the IC.

5. Connect the exposed pad directly to the top layer PGND pins and ground plane. Connect the top layer ground plane to both internal ground planes and the PCB backside ground plane with thermal vias. Provide ground plane routing on multiple layers to allow the IC's heat to flow into the PCB and then spread radially from the IC. Avoid cutting the ground planes or adding vias that restrict the radial flow of heat.
6. Make Kelvin connections to the ILIM and OLIM current sense resistors. Route the current sense signals close to each other and keep them away from noisy switching signals.
7. The current sense filter capacitors and inductors should be placed directly by their respective ISRP, ISRN, OSRP, and OSRN pins.
8. Remember that all open drain outputs need pull-up resistors.
9. The following components should be connected to the AGND plane.
 - ILIM resistor
 - OLIM resistor
 - COMP resistor and capacitors
 - VREG bypass capacitor
 - INTBP bypass capacitor
10. The ACT2861 footprint must connect the VIN pins 23, 24, and 35 on the top layer. It must connect the SW1 pins 21, 22, and 34 on the top layer. It must connect the SW2 pins 18, 19, and 33 on the top layer.

Typical Operating Characteristics

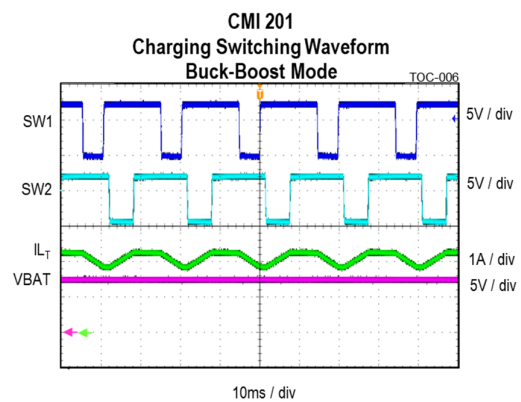
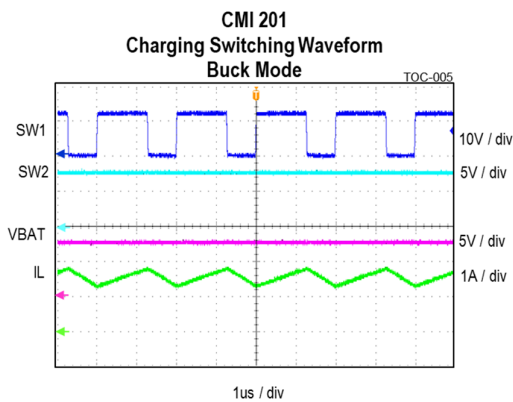
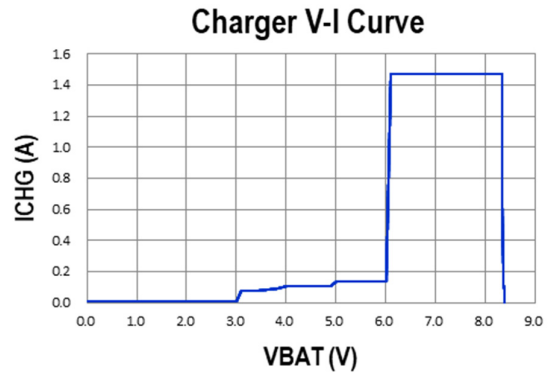
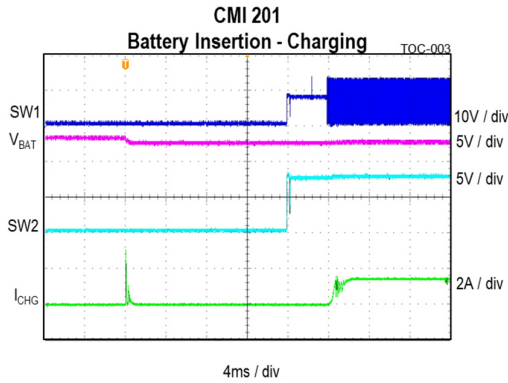
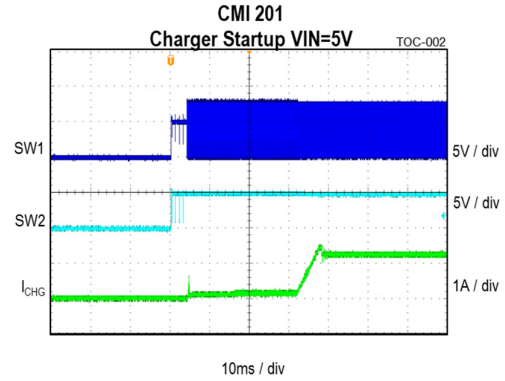
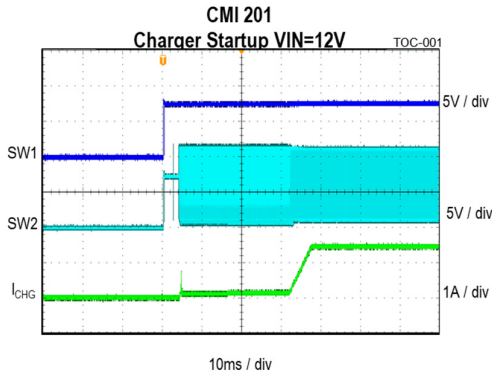

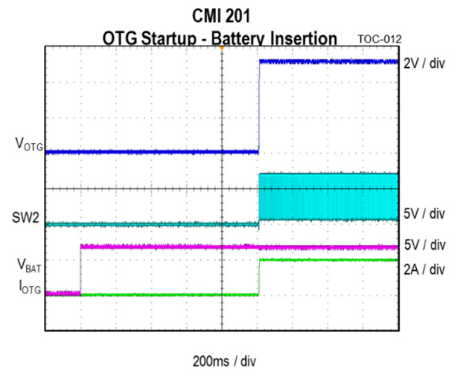
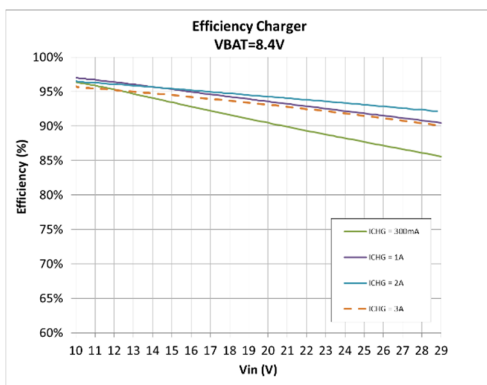
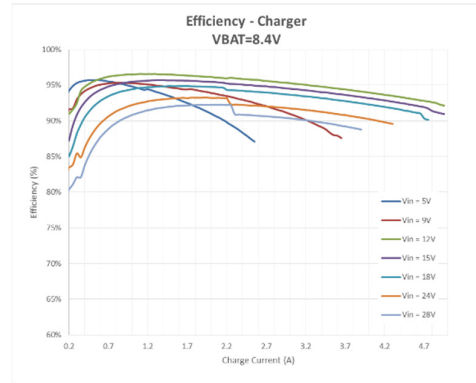
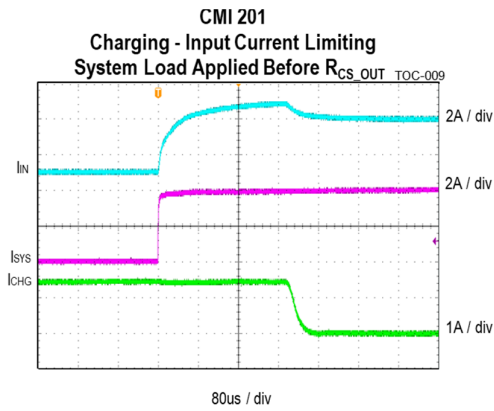
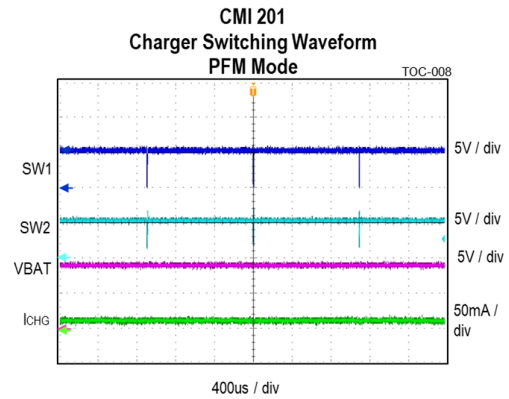
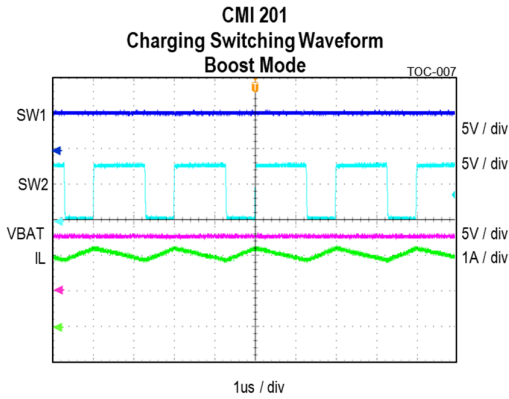

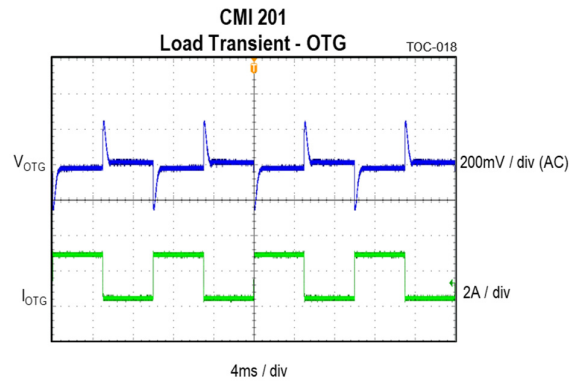
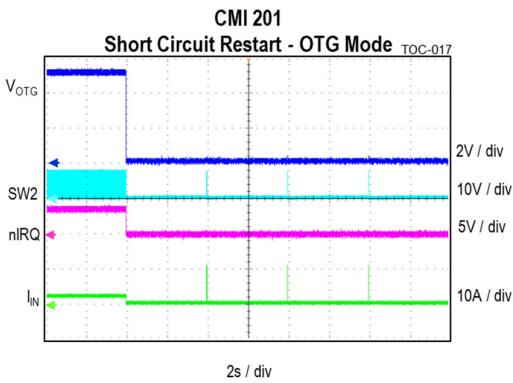
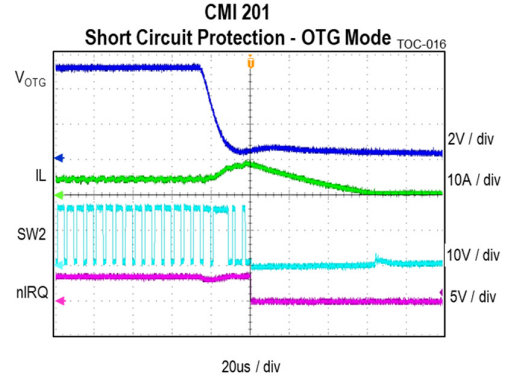
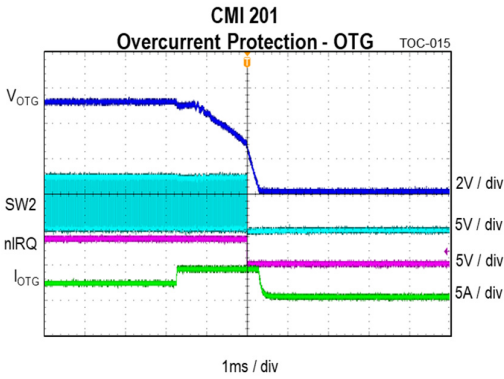
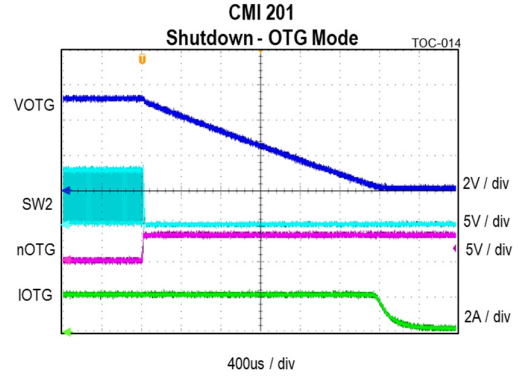
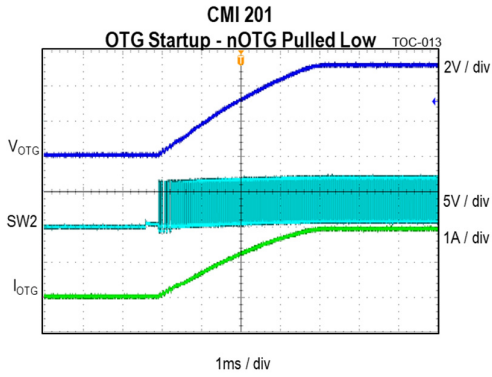

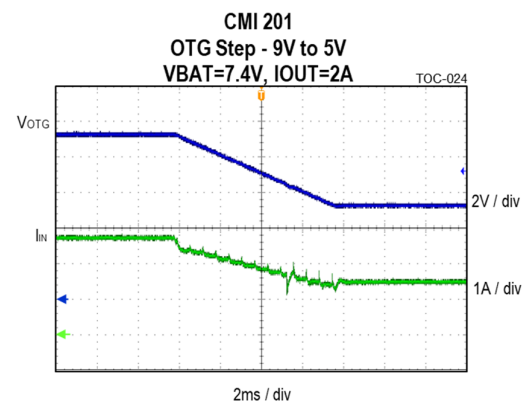
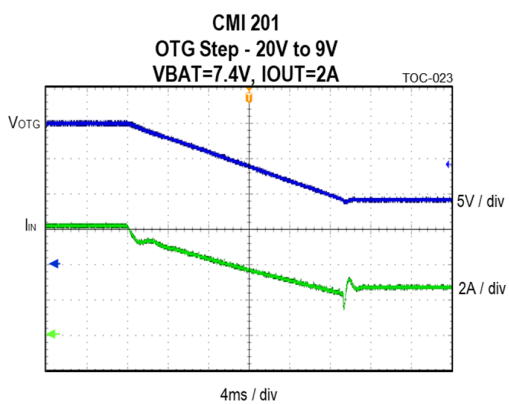
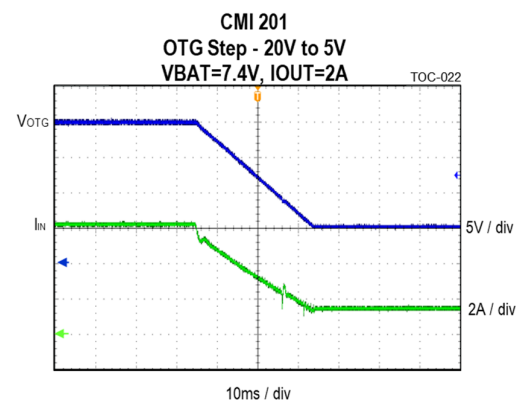
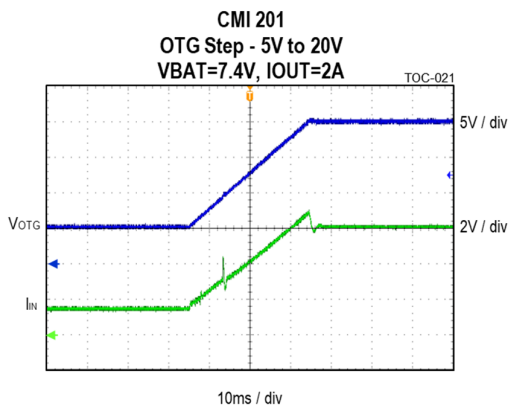
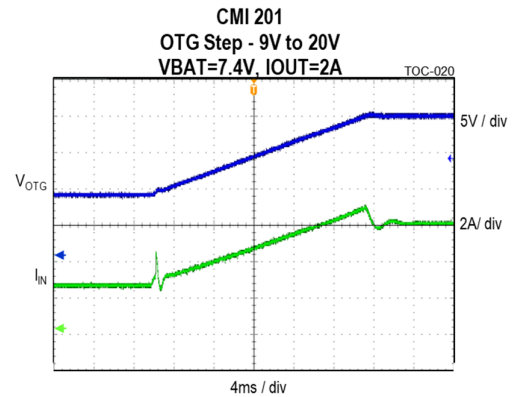
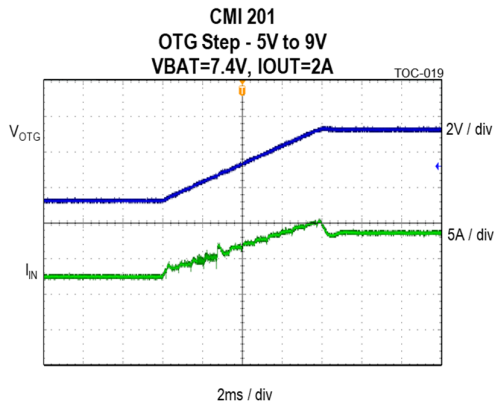

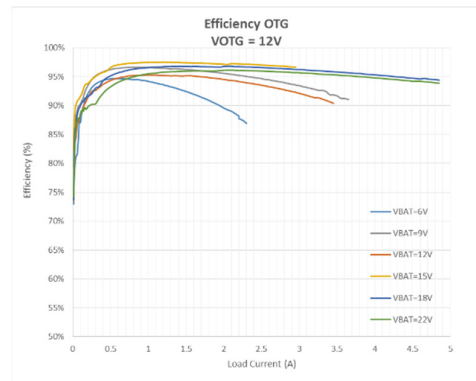
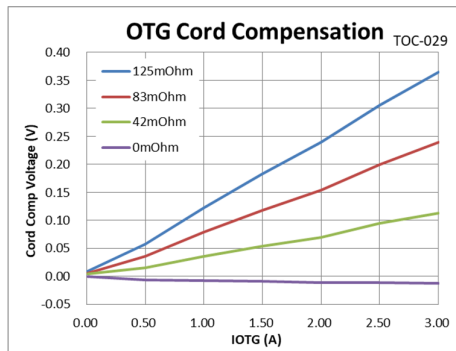
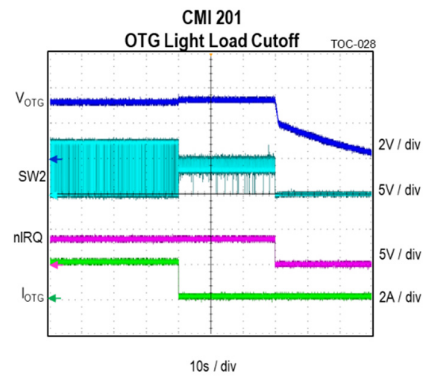
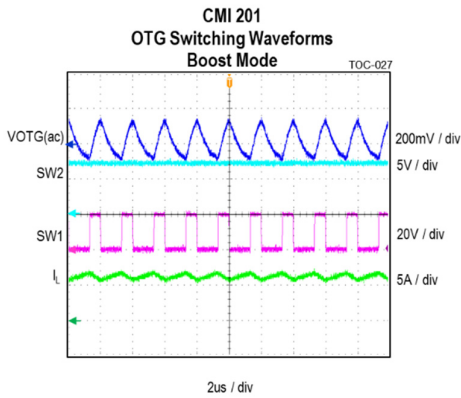
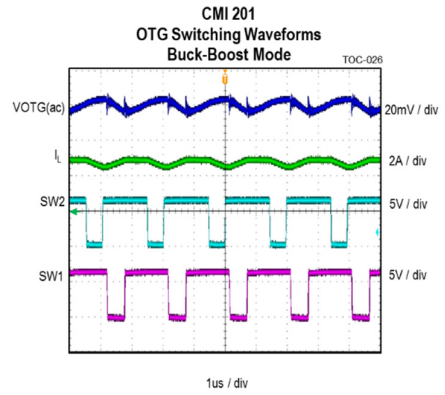
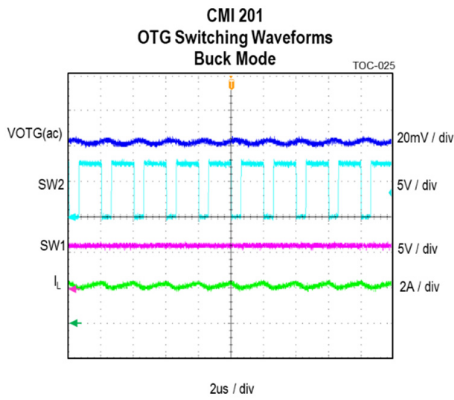

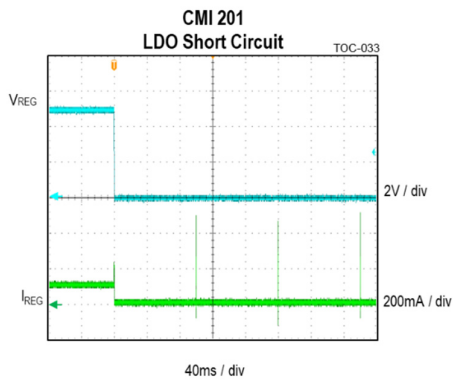
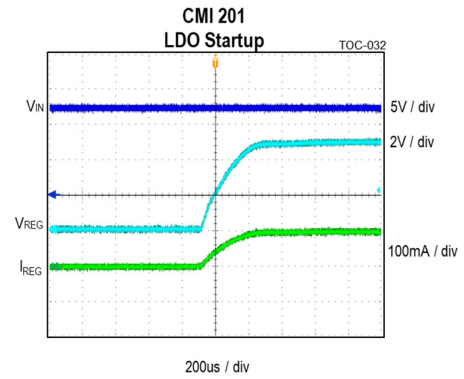
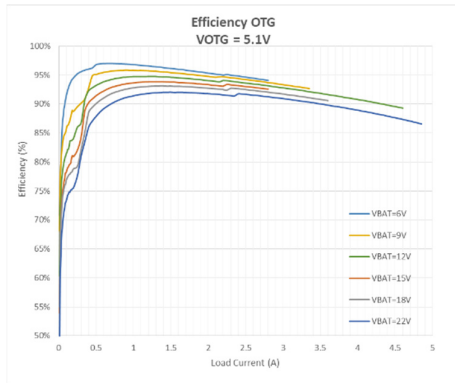

CMI OPTIONS

This section provides the basic default configuration settings for each available ACT2861 CMI option.

CMI 201: ACT2861QI201

CMI 201 is optimized for 2 cell Li-Ion battery applications and the default settings are appropriate for most typical applications. It operates with a switching frequency of 500kHz to provide an optimal tradeoff between overall size and efficiency. Table 13 shows the default register settings.

Table 13: CMI 201 Default Register Settings

Function	ACT2861QI201 Default Register Settings	Register
Battery & Charging		
Battery Termination Voltage	8.4V	VTERM
Battery Pre-Charge Voltage	6V	VBAT_LOW
Battery Short Voltage	5V	VBAT_SHORT
Battery Good Indicator Voltage (delta above Battery Pre-Charge Voltage)	0.6V	VBATGOOD
Battery Recharge Voltage (delta below VTERM)	400mV	VRECHARGE
Fast Charge Current Scaling Factor (relative to I_{OLIM})	50%	IFCHG
Battery Short Current Scaling Factor (relative to I_{OLIM})	4%	VBAT_SHORT_CURRENT
Battery Pre-Charge Current Scaling Factor (relative to I_{OLIM})	5%	IPRECHG
Battery Termination Current Scaling Factor (relative to I_{OLIM})	5%	ITERM
Battery Termination	Enabled	EN_TERM
Battery Charge Path Impedance Compensation	Disabled	BAT_PATH_COMP
Battery Path Impedance Compensation Voltage Clamp	Disabled	BAT_PATH_COMP_VCLAMP
Charging Input Current Limit Scaling Factor (relative to I_{ILIM})	67%	IINLIM
TH Pin	Enabled	DIS_TH
Non-JEITA Max Battery Temp	60 deg C	OTG_HOT
Non-JEITA Min Battery Temp	0 deg C	OTG_COLD
Minimum Input Voltage Limit (Start to reduce charger current)	4.5V	VINLIM
Start Delay (charging)	220ms	VIN_STRT_DLY
Battery OVP Latch off	Disabled	DIS_VBAT_OVP
Battery OV Deglitch Time	40ms	VBAT_OV_DEGLITCH_EN
Safety Timer	16 Hr	FC_SAFETY_TIMER
nCHG Pin Functionality in Charge Mode	Enabled	nOTG_PIN_POLARITY
JEITA		
JEITA Support	Enabled	DIS_JEITA
JEITA Warm (45°C-60°C) Termination Voltage Reduction (below VTERM)	400mV	JEITA_VSETH

JEITA Warm (45°C-60°C) Charge Current	50%	JEITA_ISETH
JEITA Cold (0°C-10°C) Charge Current	50%	JEITA_ISETC
OTG		
OTG Operation	Enabled	OTG_EN
OTG Output Voltage	5.1V	OTGVOUT_I2C
OTG Output Constant Current Limit Scaling Factor (relative to I _{LIM})	100%	OTG_CC
OTG Mode Battery Discharge Current Limit Scaling Factor (relative to I _{CHG})	200%	OTG_BAT_ILIM
OTG Softstart Time	5ms	OTG_SS
Switching Frequency	500kHz	FREQ_SEL
OTG nOTG Pin Polarity	Active Low	nOTG_PIN_POLARITY
nCHG Pin Functionality in OTG Mode	Enabled	EN_OTG_NCHG
OTG Start up Delay	1000ms	OTG_EN_DLY
OTG Cord Compensation	Disabled	OTG_CORD_COMP
OTG Battery Cut Off Voltage During Discharge (Delta below V _{BAT_LOW})	0.4V	OTG_VBAT_CUTOFF
OTG Output Slew Rate	0.5V/ms	OTG_OUTPUT_SLEW
PFM Mode in Charge and OTG modes	Enabled	OTG_DIS_PFM
OTG Light Load Turn Off	Enabled	OTG_OFF_LOAD_EN
OTG Light Load Turn Off Delay	30s	OTG_OFF_DLY
OCP Shutdown (8 FET OC cycles)	Enabled	DIS_OCP_SHUTDOWN
FET cycle by cycle current limit	10A	FET_ILIMIT & ILIM_LOW
Input OV restart time	40ms	VIN_OV_RESTART_DELAY
ADC		
ADC Enabled	Disabled	EN_ADC
VREG LDO		
VREG Enabled	Enabled	VREG_EN
VREG Output Voltage	5V	VREG
VREG Input Control	Auto	VREG_OVERRIDE
VREG Input Voltage	VIN	VREG_SELECT
Miscellaneous		
Watchdog Timer	Disabled	WATCHDOG
Die Regulation Temperature	120 deg C	TREG
7-bit I2C Slave Address	0x24h	I2CADD

CMI 301: ACT2861QI301

CMI 301 is optimized for 3 cell Li-Ion battery applications and the default settings are appropriate for most typical applications. It operates with a switching frequency of 500kHz to provide an optimal tradeoff between overall size and efficiency. Table 14 shows the default register settings.

Table 14: CMI 301 Default Register Settings

Function	ACT2861QI301 Default Register Settings	Register
Battery & Charging		
Battery Termination Voltage	12.6V	VTERM
Battery Pre-Charge Voltage	9V	VBAT_LOW
Battery Short Voltage	7.5V	VBAT_SHORT
Battery Good Indicator Voltage (delta above Battery Pre-Charge Voltage)	0.6V	VBATGOOD
Battery Recharge Voltage (delta below VTERM)	600mV	VRECHARGE
Fast Charge Current Scaling Factor (relative to I_{o_LIM})	50%	IFCHG
Battery Short Current Scaling Factor (relative to I_{o_LIM})	4%	VBAT_SHORT_CURRENT
Battery Pre-Charge Current Scaling Factor (relative to I_{oLIM})	5%	IPRECHG
Battery Termination Current Scaling Factor (relative to I_{oLIM})	5%	ITERM
Battery Termination	Enabled	EN_TERM
Battery Charge Path Impedance Compensation	+120mV	BAT_PATH_COMP
Battery Path Impedance Compensation Voltage Clamp	Disabled	BAT_PATH_COMP_VCLAMP
Charging Input Current Limit Scaling Factor (relative to I_{iLIM})	67%	IINLIM
TH Pin	Enabled	DIS_TH
Non-JEITA Max Battery Temp	65 deg C	OTG_HOT
Non-JEITA Min Battery Temp	-10 deg C	OTG_COLD
Minimum Input Voltage Limit (Start to reduce charger current)	4.5V	VINLIM
Start Delay (charging)	220ms	VIN_STRT_DLY
Battery OVP Latch off	Enabled	DIS_VBAT_OVP
Battery OV Deglitch Time	40ms	VBAT_OV_DEGLITCH_EN
Safety Timer	16 Hr	FC_SAFETY_TIMER
nCHG Pin Functionality in Charge Mode	Enabled	nOTG_PIN_POLARITY
JEITA		
JEITA Support	Enabled	DIS_JEITA
JEITA Warm (45°C-60°C) Termination Voltage Reduction Below VTERM	600mV	JEITA_VSETH
JEITA Warm (45°C-60°C) Charge Current	50%	JEITA_ISETH
JEITA Cold (0°C-10°C) Charge Current	50%	JEITA_ISETC

OTG		
OTG Operation	Enabled	OTG_EN
OTG Output Voltage	5.1V	OTGVOUT_I2C
OTG Output Constant Current Limit Scaling Factor (relative to I _{LIM})	100%	OTG_CC
OTG Mode Battery Discharge Current Limit Scaling Factor (relative to I _{CHG})	200%	OTG_BAT_ILIM
OTG Softstart Time	5ms	OTG_SS
Switching Frequency	500kHz	FREQ_SEL
OTG nOTG Pin Polarity	Active Low	nOTG_PIN_POLARITY
nCHG Pin Functionality in OTG Mode	Enabled	EN_OTG_NCHG
OTG Start up Delay	1000ms	OTG_EN_DLY
OTG Cord Compensation	Disabled	OTG_CORD_COMP
OTG Battery Cut Off Voltage During Discharge (Delta below VBAT_LOW)	0.4V	OTG_VBAT_CUTOFF
OTG Output Slew Rate	0.1V/ms	OTG_OUTPUT_SLEW
PFM Mode in Charge and OTG modes	Enabled	OTG_DIS_PFM
OTG Light Load Turn Off	Enabled	OTG_OFF_LOAD_EN
OTG Light Load Turn Off Delay	30s	OTG_OFF_DLY
OCP Shutdown (8 FET OC cycles)	Enabled	DIS_OCP_SHUTDOWN
FET cycle by cycle current limit	10A	FET_ILIMIT & ILIM_LOW
Input OV restart time	40ms	VIN_OV_RESTART_DELAY
ADC		
ADC Enabled	Disabled	EN_ADC
VREG LDO		
VREG Enabled	Enabled	VREG_EN
VREG Output Voltage	5V	VREG
VREG Input Control	Auto	VREG_OVERRIDE
VREG Input Voltage	VIN	VREG_SELECT
Miscellaneous		
Watchdog Timer	Disabled	WATCHDOG
Die Regulation Temperature	120 deg C	TREG
7-bit I2C Slave Address	0x24h	I2CADD

CMI 401: ACT2861QI401

CMI 401 is optimized for 4 cell Li-Ion battery applications and the default settings are appropriate for most typical applications. It operates with a switching frequency of 500kHz to provide an optimal tradeoff between overall size and efficiency. Table 15 shows the default register settings.

Table 15: CMI 401 Default Register Settings

Function	ACT2861QI401 Default Register Settings	Register
Battery & Charging		
Battery Termination Voltage	16.8V	VTERM
Battery Pre-Charge Voltage	12V	VBAT_LOW
Battery Short Voltage	10V	VBAT_SHORT
Battery Good Indicator Voltage (delta above Battery Pre-Charge Voltage)	0.8V	VBATGOOD
Battery Recharge Voltage (delta below VTERM)	800mV	VRECHARGE
Fast Charge Current Scaling Factor (relative to I_{o_LIM})	50%	IFCHG
Battery Short Current Scaling Factor (relative to I_{o_LIM})	4%	VBAT_SHORT_CURRENT
Battery Pre-Charge Current Scaling Factor (relative to I_{oLIM})	5%	IPRECHG
Battery Termination Current Scaling Factor (relative to I_{oLIM})	5%	ITERM
Battery Termination	Enabled	EN_TERM
Battery Charge Path Impedance Compensation	+120mV	BAT_PATH_COMP
Battery Path Impedance Compensation Voltage Clamp	Disabled	BAT_PATH_COMP_VCLAMP
Charging Input Current Limit Scaling Factor (relative to I_{iLIM})	67%	IINLIM
TH Pin	Enabled	DIS_TH
Non-JEITA Max Battery Temp	65 deg C	OTG_HOT
Non-JEITA Min Battery Temp	-10 deg C	OTG_COLD
Minimum Input Voltage Limit (Start to reduce charger current)	4.5V	VINLIM
Start Delay (charging)	220ms	VIN_STRT_DLY
Battery OVP Latch off	Enabled	DIS_VBAT_OVP
Battery OV Deglitch Time	40ms	VBAT_OV_DEGLITCH_EN
Safety Timer	16 Hr	FC_SAFETY_TIMER
nCHG Pin Functionality in Charge Mode	Enabled	nOTG_PIN_POLARITY
JEITA		
JEITA Support	Enabled	DIS_JEITA
JEITA Warm (45°C-60°C) Termination Voltage Reduction Below VTERM	600mV	JEITA_VSETH
JEITA Warm (45°C-60°C) Charge Current	50%	JEITA_ISETH
JEITA Cold (0°C-10°C) Charge Current	50%	JEITA_ISETC

OTG		
OTG Operation	Enabled	OTG_EN
OTG Output Voltage	5.1V	OTGVOUT_I2C
OTG Output Constant Current Limit Scaling Factor (relative to I _{LIM})	100%	OTG_CC
OTG Mode Battery Discharge Current Limit Scaling Factor (relative to I _{CHG})	200%	OTG_BAT_ILIM
OTG Softstart Time	5ms	OTG_SS
Switching Frequency	500kHz	FREQ_SEL
OTG nOTG Pin Polarity	Active Low	nOTG_PIN_POLARITY
nCHG Pin Functionality in OTG Mode	Enabled	EN_OTG_NCHG
OTG Start up Delay	1000ms	OTG_EN_DLY
OTG Cord Compensation	Disabled	OTG_CORD_COMP
OTG Battery Cut Off Voltage During Discharge (Delta below V _{BAT_LOW})	0.4V	OTG_VBAT_CUTOFF
OTG Output Slew Rate	0.1V/ms	OTG_OUTPUT_SLEW
PFM Mode in Charge and OTG modes	Enabled	OTG_DIS_PFM
OTG Light Load Turn Off	Enabled	OTG_OFF_LOAD_EN
OTG Light Load Turn Off Delay	30s	OTG_OFF_DLY
OCP Shutdown (8 FET OC cycles)	Enabled	DIS_OCP_SHUTDOWN
FET cycle by cycle current limit	10A	FET_ILIMIT & ILIM_LOW
Input OV restart time	40ms	VIN_OV_RESTART_DELAY
ADC		
ADC Enabled	Disabled	EN_ADC
VREG LDO		
VREG Enabled	Enabled	VREG_EN
VREG Output Voltage	5V	VREG
VREG Input Control	Auto	VREG_OVERRIDE
VREG Input Voltage	VIN	VREG_SELECT
Miscellaneous		
Watchdog Timer	Disabled	WATCHDOG
Die Regulation Temperature	120 deg C	TREG
7-bit I2C Slave Address	0x24h	I2CADD

I2C REGISTERS

The register map section provides a basic understanding of the ACT2861 registers. Note that the default values reference the CMI 201 settings.

Register	Register Name	Type	R/W	Description	Default
0x00	Master Control 1	VM	R/W	Configure various device options	0x00h
0x01	Master Control 2	NVM	R/W		0x34h
0x02	General Status	VM	R	Device status	0x00h
0x03	Charger Status	VM	R	Charger status	0x00h
0x04	Temperature Status	VM	R	Charger temperature status	0x00h
0x05	Fault 1	VM	R	Device Faults	0x00h
0x06	Fault 2	VM	R		0x00h
0x07	ADC Output 1	VM	R	ADC Output	0x00h
0x08	ADC Output 2	VM	R		0x00h
0x09	ADC Configuration 1	VM	R/W	ADC configuration bits	0x00h
0x0A	ADC Configuration 2	VM	R/W		0x00h
0x0B	Charge Control VBAT Short	NVM	R/W	Configure various charger options	0x98h
0x0C	Charge Control 2	NVM	R/W	Configure various charger options	0x40h
0x0D	Charge Control 3	NVM	R/W	Configure various charger options	0x49h
0x0E	OTG Mode Control 1	NVM	R/W	Configure OTG mode options	0xADh
0x0F	OTG Mode Control 2	NVM	R/W	Configure OTG mode options	0x43h
0x10	OTG Control 3	NVM	R/W	Configure Converter options	0x78h
0x11	Battery Regulation Voltage 1	NVM	R/W	11-bit, 5V ~ 22.5V, LSB = 10mV, Default = 4.2V	0xF1h
0x12	Battery Regulation Voltage 2	NVM	R/W		0x54h
0x13	OTG Output Voltage 1	NVM	R/W	10-bit, 3.0 ~ 23.42V, LSB = 20mV, Default = 5.1V	0xA0h
0x14	OTG Output Voltage 2	NVM	R/W		0xD6h
0x15	Input Current Limit	NVM	R/W	7-bit, 0 ~ 100%, LSB = 1%, Default = 100%	0x43h
0x16	Input Voltage Limit	NVM	R/W	8-bit, 4 ~ 16.7V, LSB = 100mV, default = 4.4V	0x05h

0x17	OTG Output Current Limit	NVM	R/W	7-bit, 0 ~ 100%, LSB = 1%, Default = 100%	0x64h
0x18	Fast Charge Current	NVM	R/W	7-bit, 0 ~ 100%, LSB = 1%, Default = 100%	0x32h
0x19	Pre-Charge & Termination Current	NVM	R/W	4-bit, 0 ~ 20%, LSB = 1%, Default = 10%	0x00h
0x1A	Battery Low Voltage	NVM	R/W	8-bit, 2.5 ~ 15.2V, LSB = 100mV, default = 3V	0x0Ah
0x1B	Safety Timer	NVM	R/W	5-bit, 0.5 ~ 16V, LSB = 0.5Hr, default = 10Hr	0x1Fh
0x1C	JEITA	NVM	R/W	JEITA Charge Voltage/Current Setting	0x1Ah
0x1D	Temperature Setting	NVM	R/W	High/Low Temperature Thresholds	0x8Bh
0x1E	IRQ Control 1	VM	R/W	IRQ Mask Control	0x00h
0x1F	IRQ Control 2	VM	R/W		0x00h
0x20	OTG Status	VM	R	OTG Status	0x00h

REG 0x00: Main Control 1 (R/W) (VM)

Bit	Name	Default Value	Description	Comment
7	<i>HIZ</i>	0	0: Not in HIZ mode 1: In HIZ mode	Bit to control if IC is in HIZ mode. If set to 1, EN_CHG will NOT enable switching for charger or and nOTG pin will not enable OTG mode. In addition, the OVERRIDE_EN_CHG or the OVERRIDE_nOTG Registers will not enable the converter.
6	<i>OVERRIDE_EN_CHG</i>	0	0: No Effect 1: Override EN_CHG Input	0: No effect 1: This will override the EN_CHG pin and allow the charging to start, even if the EN pin is low. With this set HI, enable pin will have no effect on charging. HIZ will still need to be set to 0 to allow Charging.
5	<i>SHIPM_ENTER</i>	0	0: No Change 1: Device enters ship mode	Write to 1 clears register after 1 sec 0: Normal Mode 1: Disables everything and device enters Ship Mode after a 1 second delay. During the 1 second countdown this bit will stay high. If user wants to cancel the enter ship mode during the 1 sec delay, write this back to 0, and ship mode will not be entered. Warning: Entering ship mode disables everything and must be re-enabled with SHIPM pin or VIN supply.
4	<i>GPIO_OUT</i>	0	0: Output in HIZ 1: Output pulled low	GPIO output register Only available in ACT2862 (No OTG Mode)
3	<i>DIS_nCHG_CHG</i>	0	0: Enable 1: Disable	If set to 1, nCHG Charge pin is always HIZ in Charger mode.
2	<i>WATCHDOG_RESET</i>	0	0: Normal 1: Reset	I2C Watchdog Timer Reset This must be written to 1 before Watchdog timer expires, if Watchdog timer is enabled. This is auto clearing when writing to a 1.
1	<i>Audio Frequency Limit</i>	0	0: No limit 1: Minimum 31.25kHz	0: No limit of switching frequency 1: Set minimum switching frequency to 31.25kHz to avoid audio noise For both OTG and Charge mode.
0	<i>REGISTER_RESET</i>	0	1: Reset Registers to Default	Register is self-clearing. Write to 1 resets registers and set reset register back to 0.

REG 0x01: Main Control 2 (R/W) (NVM)

Bit	Name	Default Value	Description	Comment
7	<i>DIS_TH</i>	0	0: Enable 1: Disable	Set 1 to disable TH output and the JEITA Control. During this mode, charger and OTG mode will always operate at full current and voltage settings. Note: This must be set to 1 to achieve the lowest possible input current.
6	<i>DIS_OCP_SHUTDO WN</i>	0	0: Enable 1: Disable	If set to 0, the device will be disabled if FET cycle by cycle current limit is detected for 8 (or 16) continuous cycles. For both Charge and OTG modes. Uses the <i>FET_LIMIT</i> register setting for the FET current limit.
5	<i>DIS_VBAT_OVP</i>	1	0: Enable 1: Disable	When set to 1, a BAT_OVP fault does not latch off the charger in a fault mode. Charger will restart automatically when the OVP condition is removed.
4	<i>FET_ILIMIT</i>	1	0: 8.5A 1: 10A	This is the cycle by cycle current limit setting for ALL FETS in any operating mode:
3	<i>VIN_OV_RESTART_DELAY</i>	0	0: 40ms 1: 100usec	Delay time to restart in charger mode after Input OV fault has been removed
2	<i>VREG_EN</i>	1	0: Turn OFF VREG 1: Turn ON VREG	Control VREG on/off Default is on.
1	<i>WATCHDOG[1]</i>	0	00: Disable timer 01: 80s	I2C Watchdog Timer Setting Watchdog timer is always disabled and reset to 0 in HIZ Mode. When Disabled, Watchdog timer is also reset to 0.
0	<i>WATCHDOG[0]</i>	0	10: 160s 11: 320s	

REG 0x02: General Status (Read Only) (VM)

Bit	Name	Default Value	Description	Comment
7	<i>nVBAT_GOOD</i>	0	0: Battery voltage is good 1: Battery voltage is lower than V _{BAT_GOOD}	Set bit when battery voltage is lower than VBAT_GOOD threshold in Charge Mode or OTG Mode This is not checked in HIZ Mode, so will be set to 0 in HIZ Mode. This read only register has a 16msec deglitch for rising and falling edge.
6	<i>nIRQ_PIN_Status</i>	0	0: Our device output drive HIZ 1: Our device output asserted Low	Device status of IRQ output Not actual status of the IRQ pin – Open drain output so other devices could be driving the pin low in a wired OR configuration
5	<i>nOTG_PIN_STATUS</i>	0	0: nOTG Pin Low 1: nOTG Pin High	Real time status of the nOTG input pin
4	<i>INPUT_UVLO_CHG</i>	0	0: Input above UVLO 1: Input below UVLO	Charge Mode Only Real time status – For latched fault, see the Fault Registers
3	<i>INPUT_OV_CHG</i>	0	0: Input below OV 1: Input above OV	Charge Mode Only Real time status – For latched fault, see the Fault Registers
2	<i>GPIO_IN</i>	0	0: GPIO Input Low 1: GPIO Input HI	Real Time status of GPIO Pin. Only available in ACT2862, otherwise this register is always low
1	<i>OPERATION_MODE[1]</i>	0	00: HIZ Mode 01: Charger Mode	Current state machine status for overall system
0	<i>OPERATION_MODE[0]</i>	0	10: OTG Mode 11: not valid	

REG 0x03: Charger Status (Read only) (VM)

Bit	Name	Default Value	Description	Comment
7	<i>EN_CHG_PIN_STAT</i> <i>US</i>	0	0: EN < 0.8V 1: EN > 0.8V	Real time status of the EN_CHG Input PIN Threshold shown does not include hysteresis
6	<i>THERMAL_ACTIVE</i>	0	0: Not in thermal regulation 1: Thermal regulation Active	Thermal Regulation Active in Charge AND OTG Mode
5	<i>INPUT_IINLIM_STAT</i> <i>US</i>	0	0: Not in IINLIM 1: In IINLIM	Charger Mode Only
4	<i>INPUT_VINLIM_STAT</i> <i>US</i>	0	0: Not in VINLIM 1: In VINLIM	Charger Mode Only
3	<i>CHG_STATUS[3]</i>	0	0000: RESET	State machine for charger status See Section 1.2.2. for further information Notes: When not in Charge State, status is always RESET (0000) Check Register 0x06 Bit 0 to determine if Battery is below Dead Battery level. 1100 – 1111: Not Valid
2	<i>CHG_STATUS[2]</i>	0	SCOND or SCOND_DB 0010: SCSUSPEND	
1	<i>CHG_STATUS[1]</i>	0	0011: PCOND 0100: PCSUSPEND	
0	<i>CHG_STATUS[0]</i>	0	0101: FASTCHG 0110: FCSUSPEND 0111: CHGFULL	
			1000: CFSUSPEND 1001: CHGTERM 1010: CTSUSPEND 1011: FAULT	

REG 0x04: Temperature Status (Read Only) (VM)

Bit	Name	Default Value	Description	Comment
7	<i>POK_VOUT</i>	0	0: Output below 90% 1: Output above 92%	Indicator for Power OK in OTG or CHG mode. Uses OTG_VOUT setting and measures VIN Pin during OTG. Uses VTERM setting and VBATS Pin during Charge Mode.
6	<i>TH_BAT_DETECT</i>	0	0: No Battery detected 1: Battery detected	Uses the voltage on TH pin. Can be used to detect battery or battery at very cold temperature. If DIS_TH=1, then register is always 0 – No battery detected.
5	<i>OTG_COLD_DIS / CHRG DIS_JEITA=1</i>	0	OTG Mode OR (Charge Mode AND DIS_JEITA=1) 0: OK 1: Below 0°C / -10°C input	If this bit is 1, then OTG or Charger mode is disabled caused by Battery Below 0C or -10C depending on OTG_COLD Register
4	<i>OTG_HOT_DIS / CHRG DIS_JEITA=1</i>	0	OTG Mode OR (Charge Mode AND DIS_JEITA=1) 0: OK 1: Above 55°C / 60°C / 65°C Threshold	If this bit is 1, then OTG or Charger mode is disabled caused by Battery Above 55C/60C/65C depending on OTG_HOT[1:0] Register
3	<i>CHRG_COLD</i>	0	0: Normal Charge Mode OR DIS_JEITA=1 1: Charging has stopped with DIS_JEITA=0	In charge mode, if DIS_JEITA=0, then this bit goes high when the battery temperature is less than 0°C and the device is always disabled.
2	<i>CHRG_COOL</i>	0	0: Normal Charge Mode OR DIS_JEITA=1 1: Reduced current or charge suspended	In charge mode, if DIS_JEITA=0, then this bit goes high when battery temperature is between 10°C and 0°C. In this mode, the device may be disabled, or reduced current. This is controlled by Register 0x1C Bit [1:0].
1	<i>CHRG_WARM</i>	0	0: Normal Charge Mode OR DIS_JEITA=1 1: Reduced charge voltage and/or current	In charge mode, if DIS_JEITA=0, then this bit goes high when battery temperature is between 45°C and 60°C. In this mode, the device may be have reduced current or reduced VTERM. This is controlled by Register 0x1C Bit [5:2].
0	<i>CHRG_HOT</i>	0	0: Normal Charge Mode OR DIS_JEITA=1 1: Charging has stopped	In charge mode, if DIS_JEITA=0, then this bit goes high when the battery temperature is greater than 60°C and the device is always disabled.

REG 0x05: Faults 1 (Read only) (VM)

Bit	Name	Default Value	Description	Comment
7	<i>nIRQ_Clear</i>	0	0: Normal Status 1: Clear IRQ output	Write this bit to 1 to clear the IRQ output. The bit will self-clear to a 0 once the write occurs. If a fault still occurs, then nIRQ pin may stay asserted low. Register 0x02 Bit 6 provides a real time status of the nIRQ output.
6	<i>CHG_TIMER_EXPIRE D</i>	0	0: No Fault 1: Timer Expired	The VBAT LOW or Fast Charge Safety timer has expired – Charge Only Mode. Read to clear this latching fault bit. Note: Reading this bit will not reset the fault timers. If the fault timers are high, this bit will get set again immediately after the read. See the Safety Timer section on how to reset the Safety Timers.
5	<i>CHG_VBAT_OV</i>	0	0: No Fault 1: V _{BAT} OV	V _{BAT} Overvoltage protection Charge Mode. Read to clear this latching fault bit.
4	<i>VREG_OC_UVLO</i>	0	0: No Fault 1: VREG OC or UVLO	VREG_LDO Overcurrent or UVLO Charge Mode or OTG Mode. Read to clear this latching fault bit. The fault mask bits <i>DIS_CHG_VREG_FLT</i> and <i>DIS_OTG_VREG_FLT</i> registers do not affect this fault bit. It will always get indicated here to notify the user. Note: There is a 100msec restart delay for OC faults on the VREG LDO, so the delay must expire before this bit can be reset with a read to clear.
3	<i>TSD</i>	0	0: No Fault 1: Over Temperature	Die Thermal Shutdown in Charge mode or OTG Mode. This bit is latching. Read this bit to clear the value back to 0. This bit is not cleared if the fault is still present.
2	<i>FET_OC</i>	0	0: No Fault 1: Input OC	FET Overcurrent Shutdown in Charge mode or OTG Mode. This bit is latching. Read this bit to clear the value back to 0. This bit is not cleared if the fault is still present
1	<i>CHG_MODE_INPUT_OV</i>	0	0: No Fault 1: Input Over Voltage	VIN OV in Charge Mode Read to Clear latching Bit. In Charge Mode, the OV fault time will be set by the delay time in the <i>VIN_OV_RESTART_DELAY</i> Register. This 40ms or 100usec delay must expire before a read to clear will reset this register bit.
0	<i>CHG_MODE_INPUT_UV</i>	0	0: No Fault 1: Charge VIN Under Voltage	VIN UV in Charge Mode Read to Clear latching Bit.

REG 0x06: Faults 2 (Read only) (VM)

Bit	Name	Default Value	Description	Comment
7	<i>WATCHDOG_FAULT</i>	0	0: No Fault 1: Watchdog Fault	<p>Watchdog Timeout Fault</p> <p>This bit is latching. If Watchdog is enabled and watchdog timer times out, then this bit is set high.</p> <p>This bit is not cleared when read. The watchdog timer is cleared with a watchdog read or by disabling the watchdog timer.</p>
6	<i>OTG_VOUT_FAULT</i>	0	0: No Fault 1: OTG VOUT Fault	<p>OTG Hiccup Mode Fault</p> <p>This bit is latching. Read this bit to clear the value back to 0. If the VOUT enters hiccup state because current exceeds the Constant Current Mode, then this bit gets set.</p> <p>This register will always be set during hiccup mode when VOUT is off during the 3sec restart time and converter is in the HICCUP state. After it exits this state, a read clears this bit.</p>
5	<i>OTG_VBAT_CUTOFF_FLT</i>	0	0: No Fault 1: OTG VBAT CUTOFF Fault	<p>OTG VBAT Cutoff Fault</p> <p>This bit is latching. If VBAT falls below the $V_{OTG_VBAT_CUTOFF}$ Voltage specified in the OTG_VBAT_CUTOFF Register (Reg 0x0F, Bits 7:5), this bit is set to 1.</p> <p>When the battery voltage is above the OTG_VBAT_CUTOFF voltage, a read will clear this fault bit.</p>
4	<i>OTG_VOUT_OV</i>	0	0: No Fault 1: VOUT OV Fault	<p>OTG Vout Overvoltage Fault</p> <p>Read to Clear latching bit</p> <p>This bit will be set any time the Vout exceeds the OV threshold for external or internal feedback. The VOUT must be below the OV voltage and then a read will clear this fault bit.</p>
3	<i>OTG_LIGHT_LOAD</i>	0	0: No Fault 1: OTG Off	<p>Output Light Load State Latch</p> <p>This bit is latching. This bit is set when the converter has been disabled because of light load condition on output and it entered the LL_DIS state. After the IC exits the LL_DIS state, a read clears this bit.</p>
2	<i>OTG_VBAT_OV</i>	0	0: No Fault 1: OTG VBAT OV	<p>OTG VBAT Overvoltage fault</p> <p>This bit is latching. This bit is set any time VBAT exceeds the OV threshold in OTG mode. VBAT must be below the OV voltage and then a read clears this bit.</p>
1	<i>I2C_FAULT</i>	0	0: No Fault 1: I2C Fault	<p>If set to 1, I2C command did not finish correctly or errors on I2C data</p>
0	<i>DEADBATTERY</i>	0	0: Battery above 3V 1: Battery below 3V	<p>If charging and battery is below 3V, this bit gets set to 1. This is a real-time indicator.</p>

REG 0x07: ADC Output 1 (Read only) (VM)

Bit	Name	Default Value	Description	Comment
7	<i>ADC_OUT[13]</i>	0		Selected data output from <i>ADC_READ</i> Register ADC output Upper 8 Bits of ADC output.
6	<i>ADC_OUT[12]</i>	0		
5	<i>ADC_OUT[11]</i>	0		
4	<i>ADC_OUT[10]</i>	0		
3	<i>ADC_OUT[9]</i>	0		
2	<i>ADC_OUT[8]</i>	0		
1	<i>ADC_OUT[7]</i>	0		
0	<i>ADC_OUT[6]</i>	0		

REG 0x08: ADC Output 2 (Read only) (VM)

Bit	Name	Default Value	Description	Comment
7	<i>RFU</i>	0		Reserved for future use. Do not change this register value.
6	<i>RFU</i>	0		
5	<i>ADC_OUT[5]</i>	0		Selected data output from <i>ADC_READ</i> Register Lower 6 LSB Bits of ADC Output
4	<i>ADC_OUT[4]</i>	0		
3	<i>ADC_OUT[3]</i>	0		
2	<i>ADC_OUT[2]</i>	0		
1	<i>ADC_OUT[1]</i>	0		
0	<i>ADC_OUT[0]</i>	0		

REG 0x09: ADC Configuration 1 (R/W) (VM)

Bit	Name	Default Value	Description	Comment
7	<i>EN_ADC</i>	0	0: ADC disabled 1: ADC enabled	
6	<i>ADC_ONE_SHOT</i>	0	0: ADC continually converts data when EN_ADC=1 1: ADC performs a one-time conversion when EN_ADC=1	[ADC ONE SHOT][ADC_CH_SCAN] = XX operation is described as below. 00 = Scan channel specified by ADC CHANNEL CONVERSION [2:0] register bits repeatedly in a loop. 01 = Scan and convert channels 0 – 7 repeatedly in a loop. 10 = Convert channel specified by ADC CHANNEL CONVERSION [2:0] once (one shot) 11 = Scan and convert channels 0 – 7 once and stop – one loop
5	<i>ADC_CH_SCAN</i>	0	0: Scan single channel specified by ADC_CH_CONV 1: Scan all channels	
4	<i>DIS_ADC_BUFFER</i>	0	0: ADC Buffer is enabled 1: ADC Buffer is disabled	This should always be set to 0.
3	<i>ADC_SWAP</i>	0	0: ADC Buffer is normal inputs 1: ADC Buffer swaps inputs	If very accurate measurements are required, the ADC input pair can be swapped to negate input offset errors in the Buffer AMP. This requires one read with <i>ADC_SWAP</i> =0 and one read with <i>ADC_SWAP</i> =1, then average the results.
2	<i>HW_DIE_REV[2]</i>	0		HW Die Revision For use by Active Semi
1	<i>HW_DIE_REV[1]</i>	0		
0	<i>HW_DIE_REV[0]</i>	0		

REG 0x0A: ADC Configuration 2 (R/W) (VM)

Bit	Name	Default Value	Description	Comment
7	<i>ADC_DATA_READY</i>	0	0: Data not ready 1: Data is ready	Read Only - Conversion occurred and data is ready to read
6	<i>RFU</i>	0		Reserved for future use. Do not change this register value.
5	<i>ADC_CH_I2C_READ[2]</i>	0	000 = ILIM Pin 001 = VIN	This controls the current A2D register to output on the I2C register. The A2D can provide an I2C read on a different register while processing / converting another channel.
4	<i>ADC_CH_I2C_READ[1]</i>	0	010 = VBAT 011 = OLIM	
3	<i>ADC_CH_I2C_READ[0]</i>	0	100 = TH 101 = Die temperature 110 = External Input 111 = AGND	
2	<i>ADC_CH_CONV [2]</i>	0	000 = ILIM Pin 001 = VIN	
1	<i>ADC_CH_CONV [1]</i>	0	010 = VBAT 011 = OLIM	This controls the current A2D conversion processing channel. The A2D can provide an I2C read on a different register while processing /converting another channel.
0	<i>ADC_CH_CONV [0]</i>	0	100 = TH 101 = Die temperature 110 = External Input 111 = AGND	

REG 0x0B: Charger Control 1 (R/W) (NVM)

Bit	Name	Default Value	Description	Comment
7	<i>VBAT_OV_DEGLITCH_EN</i>	1	0: No Deglitch on OV Fault 1: Deglitch of 40msec	In charge mode, deglitch for VBAT_OV to stop charging and enter Fault Mode.
6	<i>VBAT_SHORT[2]</i>	0	000: 4V (2X2V) 001: 5V (2X2.5V) 010: 6V (3X2V) 011: 7.5V (3X2.5V) 100: 8V (4X2V) 101: 10V (4X2.5V) 110: 10V (5X2V) 111: 12.5V (5X2.5V)	Battery Short voltage threshold Cross over from I _{SHRT} to I _{PRECHRG} Current
5	<i>VBAT_SHORT[1]</i>	0		
4	<i>VBAT_SHORT[0]</i>	1		
3	<i>VBAT_SHORT_CURRENT[1]</i>	1	00: 1% 01: 2%	Battery charge current when VBAT less than VBAT Short Voltage
2	<i>VBAT_SHORT_CURRENT[0]</i>	0	10: 4% 11: 8%	
1	<i>VREG_OVERRIDE</i>	0	0: Automatic Control 1: Manual Control	0: The IC automatically selects the correct VREG input supply 1: Forces the IC to use the VREG input supply defined by the <i>VREG_SELECT</i> register.
0	<i>VREG_SELECT</i>	0	0: VIN Supply 1: VBAT Supply	Defines the VREG input power source.

REG 0x0C: Charger Control 2 (R/W) (NVM)

Bit	Name	Default Value	Description	Comment
7	<i>ILIM_LOW</i>	0	0: 8.5A or 10A 1: 5.7A	Lower ILIM setting for lower power applications. If set to 0, then uses FET_ILimit (Register 0x01 Bit 4) setting. If set to 1, then FET_ILimit should be set to 1 for 5.7A setting.
6	<i>EN_TERM</i>	1	0 Converter continues to operate: 1: Converter is disabled when termination is reached	The bit determines what to do when charge current drops below ITERM: 0: Converter stays on and continues to regulate VBAT output to VTERM Voltage
5	<i>BAT_PATH_COMP_VCLAMP[2]</i>	0	000: Disable 001: V _{BAT} + 60mV 010: V _{BAT} + 120mV 011: V _{BAT} + 180mV 100: V _{BAT} + 240mV 101: V _{BAT} + 300mV 110: V _{BAT} + 360mV 111: V _{BAT} + 420mV	Battery path impedance compensation voltage clamp:
4	<i>BAT_PATH_COMP_VCLAMP[1]</i>	0		
3	<i>BAT_PATH_COMP_VCLAMP[0]</i>	0		
2	<i>BAT_PATH_COMP [2]</i>	0	000: Disable 001: 20mΩ 010: 40mΩ 011: 60mΩ 100: 80mΩ 101: 100mΩ 110: 120mΩ 111: 140mΩ	Battery Charging path impedance compensation
1	<i>BAT_PATH_COMP[1]</i>	0		
0	<i>BAT_PATH_COMP[0]</i>	0		

REG 0x0D: Charger Control 3 (R/W) (NVM)

Bit	Name	Default Value	Description	Comment
7	VRECHARGE[2]	0	000: 200mV 001: 300mV 010: 400mV 011: 450mV 100: 500mV	A battery voltage below VTERM restarts charging when in the CHG Termination State. Allows for 2-5 Cell with 100mV or 150mV setting or 200mV up to 4 cells.
6	VRECHARGE[1]	1	101: 600mV 110: 750mV	
5	VRECHARGE[0]	0	111: 800mV	
4	VIN_STRT_DLY[1]	0	00: No delay 01: 220ms	Delay time to start the charger when after the charger is enabled
3	VIN_STRT_DLY[0]	1	10: 500ms 11: 1.3s	
2	DIS_CHG_VREG_FLT	0	0: Enable 1: Disable	If set to 0, an overcurrent or UVLO fault on the VREG will stop charging mode (goes to FAULT Mode). If set to 1, charging mode will continue with fault on VREG.
1	VBATGOOD[1]	0	00: VBAT_LOW + 0.4V 01: VBAT_LOW + 0.6V	Battery good threshold reference to VBAT_LOW Register setting for Charge Mode
0	VBATGOOD[0]	1	10: VBAT_LOW + 0.8V 11: VBAT_LOW + 1.0V	

REG 0x0E: OTG Mode Control 1 (R/W) (NVM)

Bit	Name	Default Value	Description	Comment
7	<i>OTG_EN</i>	1	0: Disable 1: Enable	If this bit is low, OTG mode is always disabled. If this pin is High, then either the nOTG pin or the EN_OTG_OVERRIDE bit will enable the OTG Mode. In addition, the HIZ mode bit (Reg 0x00, bit 7) must be low.
6	<i>OTG_EN_OVERRIDE</i>	0	0: Disable 1: Enable	If this bit is high, nOTG pin is over written and OTG mode is enabled by the EN_OTG bit. This allows user to enable OTG from I2C without using the nOTG pin.
5	<i>OTG_SS</i>	1	0: 1.5ms 1: 5ms	Soft start time for OTG output voltage:
4	<i>RFU</i>	0		Reserved for future use
3	<i>OTG_OFF_DLY[1]</i>	1	00: Disable 01: 10s	When light load is detected for the setting time, the OTG is disabled and latched off. The OTG must be disabled and re-enabled to turn OTG back on. This can be done with the nOTG Pin, or through the OTG_EN Register
2	<i>OTG_OFF_DLY[0]</i>	1	10: 20s 11: 30s	
1	<i>nOTG_PIN_POLARITY</i>	0	0: Active Low 1: Active High	Controls the polarity of the nOTG input pin.
0	<i>OTG_OFF_LOAD_EN</i>	1	0: Disable 1: Enable	When light load is detected for longer than the OFF_DLY time, the converter is disabled and latched off. The converter must be disabled and re-enabled to turn back on. This can be done with the EN pin or the EN register bit.

REG 0x0F: OTG Mode Control 2 (R/W) (NVM)

Bit	Name	Default Value	Description	Comment
7	<i>OTG_VBAT_CUTOFF[2]</i>	0	000: V _{BAT_LOW}	Battery Cut Off threshold for OTG mode to operate. Referenced from V _{BAT_LOW} level.
6	<i>OTG_VBAT_CUTOFF[1]</i>	1	001: V _{BAT_LOW} -0.2V 010: V _{BAT_LOW} -0.4V 011: V _{BAT_LOW} -0.6V	
5	<i>OTG_VBAT_CUTOFF[0]</i>	0	100: V _{BAT_LOW} -0.8V 101: V _{BAT_LOW} -1.0V 110: V _{BAT_LOW} -1.2V 111: V _{BAT_LOW} -1.4V	
4	<i>EN_OTG_nCHG</i>	0	0: Disable 1: Enable	
3	<i>OTG_CORD_COMP[1]</i>	0	00: Disable	OTG Cord Compensation at 2.4A Load with 10mΩ resistor
2	<i>OTG_CORD_COMP[0]</i>	0	01: 100mV 10: 200mV 11: 300mV	
1	<i>OTG_EN_DLY[1]</i>	1	00: 0ms 01: 200ms	The delay before enabling the OTG output from the nOTG pin or OTG register bit.
0	<i>OTG_EN_DLY[0]</i>	1	10: 500ms 11: 1s	

REG 0x10: OTG Mode Control 3 (R/W) (NVM)

Bit	Name	Default Value	Description	Comment
7	<i>OTG_OUTPUT_SLEW[1]</i>	0	00: 1V/ms 01: 0.5V/ms	If OTG Mode is set to internal Feedback and output voltage is changed using the OTG_VOUT register for QC2.0/3.0 or USB PD voltage ramp, this register controls the rate at which the output voltage changes.
6	<i>OTG_OUTPUT_SLEW[0]</i>	1	10: 0.33V/ms 11: 0.1V/ms	
5	<i>OTG_PULLDOWN_RAMP</i>	1	0: Disable 1: Enable	If OTG_PULLDOWN_RAMP is set to 1 and OTG_I2C is set to 0 for internal Feedback, an internal current source pulls down on the OTG output during a ramp down of the output voltage. This allows the OTG output to meet the QC 2.0/3.0 and USB PD ramp timing requirements.
4	<i>OTG_PULLDOWN_OV</i>	1	0: Disable 1: Enable	If OTG_PULLDOWN_OV is set to 1, the pulldown current source pulls down on the OTG output during any OV condition on the output.
3	<i>OTG_BAT_ILIM[1]</i>	1	00: Disable 01: 150% of IFCHG	The OTG input current limit scaling factor relative to the hardware programmed OLIM current setting.
2	<i>OTG_BAT_ILIM[0]</i>	0	10: 200% of IFCHG 11: 150% of IFCHG	
1	<i>DIS_OTG_VREG_FLT</i>	0	0: Enable 1: Disable	If set to 0, an Overcurrent or UVLO fault on the VREG will stop OTG mode. If set to 1, OTG mode will continue with fault on VREG.
0	<i>OTG_DIS_PFM</i>	0	0: Enable 1: Disable	Disable PFM mode in OTG or Charge mode to set a fixed switching frequency.

REG 0x11: Battery Regulation Voltage 1 (R/W) (NVM)

Bit	Name	Default Value	Description	Comment
7	VREG[4]	1	1600mV	VREG LDO Output Voltage Offset: 2V Range: 2V (00000) - 5.1V (11111)
6	VREG[3]	1	800mV	
5	VREG[2]	1	400mV	
4	VREG[1]	1	200mV	
3	VREG[0]	0	100mV	
2	VTERM[10]	0	10240 mV	Charge Voltage: See Register 0x11 for details
1	VTERM[9]	0	5120 mV	
0	VTERM[8]	1	2560 mV	

REG 0x12: Battery Regulation Voltage 2 (R/W) (NVM)

Bit	Name	Default Value	Description	Comment
7	VTERM[7]	0	1280 mV	Charge Voltage Offset: 5V Range: 5V to 22.5V 5V: 000_0000_0000 22.5V: 110_1101_0110 Voltage over 22.5V will be set at 22.5V Range: (110_1101_0111 to (111_1111_1111) = 22.5V
6	VTERM[6]	1	640 mV	
5	VTERM[5]	0	320 mV	
4	VTERM[4]	1	160 mV	
3	VTERM[3]	0	80 mV	
2	VTERM[2]	1	40 mV	
1	VTERM[1]	0	20 mV	
0	VTERM[0]	0	10 mV	

REG 0x13: OTG Output Voltage 1 (R/W) (NVM)

Bit	Name	Default Value	Description	Comment
7	<i>RFU</i>	1		Reserved for future use. Do not change this register value.
6	<i>RFU</i>	0		
5	<i>RFU</i>	1		
4	<i>RFU</i>	0		
3	<i>OTGVOUT_I2C</i>	0	0: I2C Register 1: External Resister Divider using IFB	When set to 0, the OTG output voltage is controlled by the OTG_VOUT registers. When set to 1, the output voltage is controlled by an external resistor divider connected to the IFB pin.
2	<i>OTG_VOUT[9]</i>	0	10240 mV	Internal divider network Offset: 2.96V
1	<i>OTG_VOUT[8]</i>	0	5120 mV	Range: 2.96V (000_0000_0000) to 23.42V (111_1111_1111)
0	<i>OTG_VOUT[7]</i>	0	2560 mV	

REG 0x14: OTG Output Voltage 2 (R/W) (NVM)

Bit	Name	Default Value	Description	Comment
7	OTG_VOUT[6]	1	1280 mV	Internal divider network Offset: 2.96V Range: 2.96V (000_0000_0000) to 23.42V (111_1111_1111)
6	OTG_VOUT[5]	1	640 mV	
5	OTG_VOUT[4]	0	320 mV	
4	OTG_VOUT[3]	1	160 mV	
3	OTG_VOUT[2]	0	80 mV	
2	OTG_VOUT[1]	1	40 mV	
1	OTG_VOUT[0]	1	20 mV	
0	NA	0	No Function	

REG 0x15: Input Current Limit (R/W) (NVM)

Bit	Name	Default Value	Description	Comment
7	DIS_IIN_Limit	0	0: Enable 1: Disable	Disable input current limit
6	IINLIM[6]	1	64%	The input current limit scaling factor relative to the hardware programmed ILIM current setting. Range: 1% (000_0001) to 100% (110_0100) Setting 110_0100 to 111_1111 = 100% Setting 000_0000 to 000_0001 = 1%
5	IINLIM[5]	0	32%	
4	IINLIM[4]	0	16%	
3	IINLIM[3]	0	8%	
2	IINLIM[2]	0	4%	
1	IINLIM[1]	1	2%	
0	IINLIM[0]	1	1%	

REG 0x16: Input Voltage Limit (R/W) (NVM)

Bit	Name	Default Value	Description	Comment
7	<i>DIS_VIN_Limit</i>	0	0: Enable 1: Disable	Disable input voltage limit
6	<i>VINLIM[6]</i>	0	6400 mV	Input voltage limit threshold. Charge current will be reduced to regulate input voltage at setpoint when in Charge Mode. Offset: 4.0V Range: 4.0V (000_0000) to 16.7V (111_1111)
5	<i>VINLIM[5]</i>	0	3200 mV	
4	<i>VINLIM[4]</i>	0	1600 mV	
3	<i>VINLIM[3]</i>	0	800 mV	
2	<i>VINLIM[2]</i>	1	400 mV	
1	<i>VINLIM[1]</i>	0	200 mV	
0	<i>VINLIM[0]</i>	1	100 mV	

REG 0x17: OTG Mode Output Current Limit (R/W) (NVM)

Bit	Name	Default Value	Description	Comment
7	<i>OTG_DIS_CC</i>	0	0: Enable 1: Disable	Set 1 to disable the output constant current limit function in OTG Mode
6	<i>OTG_CC[6]</i>	1	64%	The OTG output current limit scaling factor relative to the hardware programmed ILIM current setting. (VIN side measured at ISRN and ISRP) Range: 1% (000_0001) to 100% (110_0100) Setting 110_0100 to 111_1111 = 100% Setting 000_0000 to 000_0001 = 1%
5	<i>OTG_CC[5]</i>	1	32%	
4	<i>OTG_CC[4]</i>	0	16%	
3	<i>OTG_CC[3]</i>	0	8%	
2	<i>OTG_CC[2]</i>	1	4%	
1	<i>OTG_CC[1]</i>	0	2%	
0	<i>OTG_CC[0]</i>	0	1%	

REG 0x18: Fast Charge Current (R/W) (NVM)

Bit	Name	Default Value	Description	Comment
7	RFU	0		Reserved for future use
6	IFCHG[6]	0	64%	The fast charge current scaling factor relative to the hardware programmed I _{OLIM} current setting. Range: 1% (000_0001) to 100% (110_0100) Setting 110_0100 to 111_1111 = 100% Setting 000_0000 to 000_0001 = 1%
5	IFCHG[5]	1	32%	
4	IFCHG[4]	1	16%	
3	IFCHG[3]	0	8%	
2	IFCHG[2]	0	4%	
1	IFCHG[1]	1	2%	
0	IFCHG[0]	0	1%	

REG 0x19: Pre-Charge & Termination Current (R/W) (NVM)

Bit	Name	Default Value	Description	Comment
7	IPRECHG[3]	0	8%	The pre-charge current scaling factor relative to the hardware programmed I _{OLIM} current setting. Range: 5% (0000) ~ 20% (1111) Default: 10% (0101) Offset: 5%
6	IPRECHG[2]	0	4%	
5	IPRECHG[1]	0	2%	
4	IPRECHG[0]	0	1%	
3	ITERM[3]	0	8%	The termination current scaling factor relative to the hardware programmed I _{OLIM} current setting. Range: 5% (0000) ~ 20% (1111) Default: 10% (0101) Offset: 5%
2	ITERM[2]	0	4%	
1	ITERM[1]	0	2%	
0	ITERM[0]	0	1%	

REG 0x1A: Battery Low Voltage (R/W) (NVM)

Bit	Name	Default Value	Description	Comment
7	RFU	0		Reserved for future use. Do not change this register value.
6	VBAT_LOW[6]	0	6400 mV	Battery low voltage setting where pre-charge transitions to fast charge when charging. Offset: 5V Range: 5V (0000000) ~ 15.2V (1111111)
5	VBAT_LOW[5]	0	3200 mV	
4	VBAT_LOW[4]	0	1600 mV	
3	VBAT_LOW[3]	1	800 mV	
2	VBAT_LOW[2]	0	400 mV	
1	VBAT_LOW[1]	1	200 mV	
0	VBAT_LOW[0]	0	100 mV	

REG 0x1B: Safety Timer (R/W) (NVM)

Bit	Name	Default Value	Description	Comment
7	<i>RFU</i>	0		Reserved for future use. Do not change this register value.
6	<i>DIS_SAFETY_TIMER</i>	0	0: Enable 1: Disable	Disables both the Fast Charge and VBAT Low safety timers. This also resets both safety timers. When this bit is set to 1, the timers are held in reset (at 0). When this bit is written back to 0, the timers start counting.
5	<i>SUSPEND_SAFETY_TIMER</i>	0	0: Counting 1: Suspend	If this is set to 1, both the Fast Charge and VBAT Low Safety Timers stop counting and retain their current timer value. When this bit is written back to 0, the counter resumes counting from where it was suspended. If the counter is disabled during a suspend condition using the <i>DIS_SAFETY_TIMER</i> bit, the counter is reset to 0, even if suspended. It is then held at 0 until <i>SUSPEND_SAFETY_TIMER</i> is set to 0. <i>DIS_SAFETY_TIMER</i> reset has priority over <i>SUSPEND_SAFETY_TIMER</i> .
4	<i>FC_SAFETY_TIMER[4]</i>	1	8 hours	Timer setting for the Fast Charge State only. When this timer expires, Fast charging stops and sets the Timer Expired bit. Range: 0.5 (00000) ~ 16 hours (11111) Default: 10 hours (10011) Offset: 0.5 hour
3	<i>FC_SAFETY_TIMER[3]</i>	1	4 hours	
2	<i>FC_SAFETY_TIMER[2]</i>	1	2 hours	
1	<i>FC_SAFETY_TIMER[1]</i>	1	1 hours	
0	<i>FC_SAFETY_TIMER[0]</i>	1	30 mins	

REG 0x1C: JEITA (R/W) (NVM)

Bit	Name	Default Value	Description	Comment
7	DIS_LDO_TSHUT	0	0: Enabled 1: Disabled	Disables the Thermal Shutdown for the LDO regulator. This should be set to 0
6	DIS_JEITA	0	0: Use JEITA profile settings below 1: Use OTG_COLD and OTG_HOT settings to disable charge modes	
5	JEITA_VSETH [2]	0	000: VTERM 001: VTERM-200mV	JEITA Warm (45°C-60°C) Temperature Voltage Setting DIS_JEITA = 0
4	JEITA_VSETH[1]	1	010: VTERM-300mV 011: VTERM-400mV	
3	JEITA_VSETH[0]	1	100: VTERM-450mV 101: VTERM-500mV 110: VTERM-600mV 111: VTERM-750mV	
2	JEITA_ISETH	0	0: 50% of ICHG 1: 100% of ICHG	Fast Charge Current Only JEITA Warm (45°C-60°C) Temperature Current Setting Percentage with respect to ICHG register DIS_JEITA = 0 Notes: <ol style="list-style-type: none"> 1. Result for 50% is rounded down Example: 15% IFCHG at 50% reduction results in 7% output 2. Result minimum is always 1% Example: 1% IFCHG setting at 50% reduction is still 1%
1	JEITA_ISETC[1]	1		Fast Charge Current JEITA Low (0°C-10°C) Temperature Current Setting Percentage with respect to ICHG register DIS_JEITA = 0 Notes: <ol style="list-style-type: none"> 1. Result for 50% and 25% is rounded down Example: 15% IFCHG setting at 50% results in 7% output 2. Result minimum is always 1% Example: 2% IFCHG setting at 25% reduction is still 1%
0	JEITA_ISETC[0]	0	00: Charge Suspend 01: 25% of ICHG 10: 50% of ICHG 11: 100% of ICHG	

REG 0x1D: Temperature Setting (R/W) (NVM)

Bit	Name	Default Value	Description	Comment
7	<i>FREQ_SEL[1]</i>	1	Frequency Selection Settings for SMPS 00: 125kHz	Operation Frequency Settings Note: These can NOT be changed “on the fly” and each setting requires a different inductor value and capacitors and compensation components. CARE SHOULD BE TAKEN WHEN WRITING TO THIS REGISTER TO AVOID CHANGING THE FREQUENCY WHILE OPERATING
6	<i>FREQ_SEL[0]</i>	0	01: 250kHz 10: 500kHz 11: 1MHz	
5	<i>DIS_SHIP_REENTER</i>	0	0: Enable re-enter ship mode 1: Disable ship mode re-enter	If set to 0, writing to SHIPM_ENTER (Reg 0x00h Bit 5) allows the IC to re-enter ship mode. If set to 1, the IC ignores the SHIPM_ENTER command.
4	<i>OTG_HOT[1]</i>	0	00: V _{TH55C} at 55°C 01: V _{TH60C} at 60°C	OTG mode or Disable JEITA Mode Hot Temperature Monitor TH / NTC Thresholds
3	<i>OTG_HOT[0]</i>	1	10: V _{TH65C} at 65°C 11: Disable shutdown	
2	<i>OTG_COLD</i>	0	0: V _{TH0C} at 0°C 1: V _{TH-10C} at -10°C	OTG mode or Disable JEITA Mode Cold Temperature Monitor TH / NTC Thresholds
1	<i>TREG[1]</i>	1	00: Disable 01: 80°C	Die temperature regulation threshold
0	<i>TREG[0]</i>	1	10: 100°C 11: 120°C	

REG 0x1E: IRQ Control 1 R/W (VM)

Bit	Name	Default Value	Description	Comment
7	<i>nIRQ_CHGDONE</i>	0	0: Either CHG Done state triggers nIRQ pin 1: Masks nIRQ	If set to 0, any time the device enters the CHGTERM or CHGFULL state, it activates the nIRQ Pin Setting to 1, masks CHG done states to nIRQ
6	<i>nIRQ_VBAT_GOOD</i>	0	0: VBAT_GOOD falling edge triggers nIRQ 1: Masks nIRQ	If set to 0, VBAT_GOOD falling below threshold activates the nIRQ Pin Setting to 1, masks VBAT_GOOD to nIRQ
5	<i>nIRQ_CHG_OVUV</i>	0	0: Charge Mode OVUV nIRQ 1: Masks nIRQ	If set to 0, a Overvoltage or Undervoltage on VIN during charge mode activates the nIRQ Pin Setting to 1, masks the Overvoltage or Undervoltage to nIRQ
4	<i>nIRQ_OTG_VBAT</i>	0	0: OTG Mode VBAT Cutoff or Over Voltage on nIRQ 1: Masks nIRQ	If set to 0, a VBAT below VBAT Cutoff or VBAT Overvoltage during OTG mode activates the nIRQ Pin Setting to 1, masks the fault to nIRQ
3	<i>nIRQ_SafetyTimer</i>	0	0: Charge Mode safety timer expired on nIRQ 1: Masks nIRQ	If set to 0, a VBAT Low safety timer expired or a Fast Charge safety timer expired during charge mode activates the nIRQ Pin Setting to 1, masks the fault to nIRQ
2	<i>nIRQ_CHG_VBAT_OV</i>	0	0: Charge Mode VBAT Overvoltage on nIRQ 1: Masks nIRQ	If set to 0, a VBAT Overvoltage during charge mode activates the nIRQ Pin Setting to 1, masks the fault to nIRQ
1	<i>nIRQ_VREG_FLT</i>	0	0: VREG LDO Overcurrent or Undervoltage indicated on nIRQ 1: Masks nIRQ	If set to 0, a VREG LDO Overcurrent or Undervoltage activates the nIRQ pin Setting to 1, masks the fault to nIRQ
0	<i>nIRQ_TSD</i>	0	0: Device Thermal Shutdown indicated on nIRQ 1: Masks nIRQ	If set to 0, a device Thermal Shutdown activates the nIRQ pin Setting to 1, masks the fault to nIRQ

REG 0x1F: IRQ Control 2 R/W (VM)

Bit	Name	Default Value	Description	Comment
7	<i>nIRQ_FET_OC</i>	0	0: FET Overcurrent triggers nIRQ pin 1: Masks nIRQ	If set to 0, a FET Overcurrent condition activates the nIRQ pin Setting to 1, masks CHG done states to nIRQ
6	<i>nIRQ_Watchdog</i>	0	0: Watchdog timer expired triggers nIRQ 1: Masks nIRQ	If set to 0, a watchdog timeout activates the nIRQ pin Setting to 1, masks the fault nIRQ
5	<i>nIRQ_OTG_HICCUP</i>	0	0: OTG Mode enter Hiccup state nIRQ 1: Masks nIRQ	If set to 0, OTG Mode entering Hiccup state activates the nIRQ pin Setting to 1, masks hiccup mode to nIRQ
4	<i>nIRQ_OTG_LL</i>	0	0: OTG Mode enter Light Load state on nIRQ 1: Masks nIRQ	If set to 0, OTG Mode entering Light Load Disable state activates the nIRQ pin Setting to 1, masks light load disable state to nIRQ
3	<i>nIRQ_A2D_DATA</i>	0	0: A2D Data Ready 1: Masks A2D Data Ready nIRQ	If set to 0, a rising edge on A2D Data Ready activates the nIRQ pin Setting to 1, masks the A2D Data Ready to nIRQ
2	<i>nIRQ_HIZ</i>	0	0: Enter HIZ Mode 1: Masks Enter HIZ Mode nIRQ	If set to 0, a rising edge when entering HIZ State activates the nIRQ pin Setting to 1, masks the HIZ Enter to nIRQ
1	<i>nIRQ_CHG_SUSPEND</i>	0	0: Enter charge suspend mode 1: Masks Enter charge suspend mode nIRQ	If set to 0, a rising edge when entering a suspend state in charge mode activates the nIRQ pin Setting to 1, masks the charge suspend enter to nIRQ
0	<i>nIRQ_OTG_BATTEMP</i>	0	0: OTG BAT Temp Fault 1: Masks OTG BAT Temp Fault nIRQ	If set to 0, a rising edge caused by Battery Temp HOT or COLD in OTG Mode activates the nIRQ pin Setting to 1, masks the nIRQ

REG 0x20: IRQ / OTG Status (R/W) (VM)

Bit	Name	Default Value	Description	Comment
7	<i>nIRQ_I2C_ERROR</i>	0	0: I2C Fault 1: Masks I2C Fault nIRQ	If set to 0, a fault on the I2C command / I2C bus activates the nIRQ Pin Setting to 1, masks the nIRQ
6	<i>OTG_BATTERY_CC</i>	0	0: OTG Input from battery no in current limit 1: OTG input from battery is regulating in Constant Current Mode	OTG Mode Only Real Time status This is the current measured on the VBAT side using OSRP and OSRN during OTG Mode controlled by the <i>OTG_BAT_ILIM</i> Register
5	<i>OTG_OUTPUT_CC</i>	0	0: OTG Output regulating using voltage loop 1: OTG output is regulating in Constant Current Mode	OTG Mode Only Real Time status This is the current measured on the VIN side using ISRP and ISRN during OTG Mode controlled by the <i>OTG_CC</i> Register
4	<i>VBAT_CUTOFF_OTG</i>	0	0: VBAT above <i>VBAT_CUTOFF_OTG</i> 1: VBAT below <i>VBAT_CUTOFF_OTG</i>	OTG Mode only Real time status – For latched fault, see the Fault Registers
3	<i>VBAT_OV_OTG</i>	0	0: VBAT below OV 1: VBAT above OV	OTG Mode only Real time status – For latched fault, see the Fault Registers
2	<i>OTG_STATUS[2]</i>	0	000: OTG_RST 001: OTG_SS 010: OTG_REG 011: OTG_HICCUP 100: OTG_LL_DIS	State machine for OTG status Note: When not in OTG State, status is always RESET (000) 101 – 111: Not Valid
1	<i>OTG_STATUS[1]</i>	0		
0	<i>OTG_STATUS[0]</i>	0		

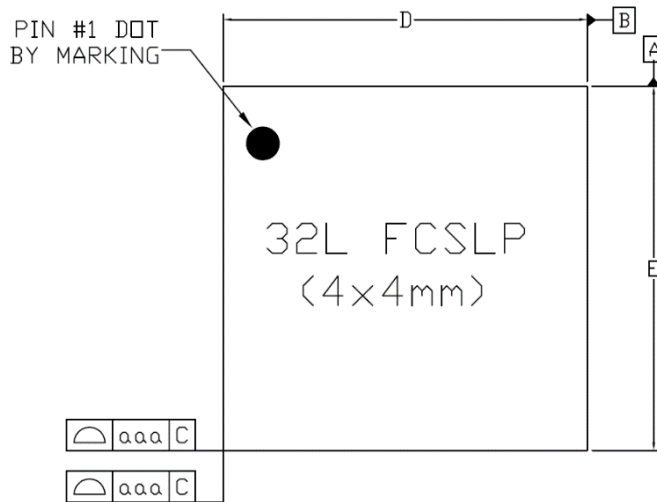
PACKAGE OUTLINE AND DIMENSIONS QFN4X4-32

TOP VIEW

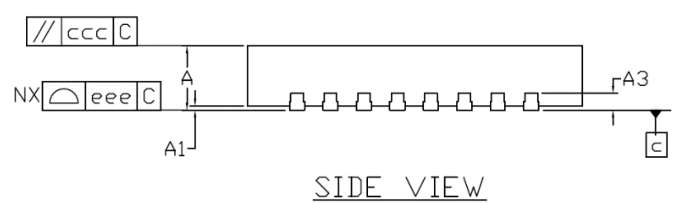

Dimensional Ref.			
REF.	Min.	Nom.	Max.
A	0.800	0.850	0.900
A1	---	---	0.050
A3	0.203 Ref.		
D	3.950	4.000	4.050
E	3.950	4.000	4.050
D2	1.550	1.600	1.650
E2	0.950	1.000	1.050
	--		
b	0.150	0.200	0.250
e	0.400 BSC		
L1	0.350	0.400	0.450
L2	0.750	0.800	0.850
Tol. of Form&Position			
aaa	0.10		
bbb	0.10		
ccc	0.10		
ddd	0.05		
eee	0.08		
fff	0.10		

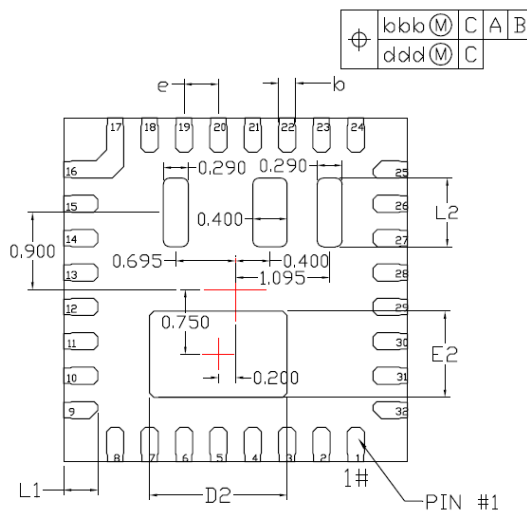

All dimensions are in millimeters

Dimensioning and tolerancing per JEDED MO-232

See Active Semi Application note AN-104, QFN PCB Layout Guidelines for more information on generating the ACT2861 land pattern.