

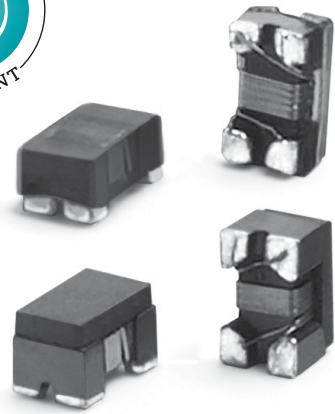





SMD CHIP CHOKES

Wire-Wound Series



-  Wire wound Ferrite 1210 (3225) core
-  Common Mode Noise suppression without attenuating the signal
-  Magnetically shielded for low Rdc and High Current
-  Perfect for USB2.0/3.0, IEEE1349 Fire wire and other LVDS lines
-  Ideal for DC voltage supply lines for Power over Ethernet -PoE/PoE+

PART NUMBER LEGEND

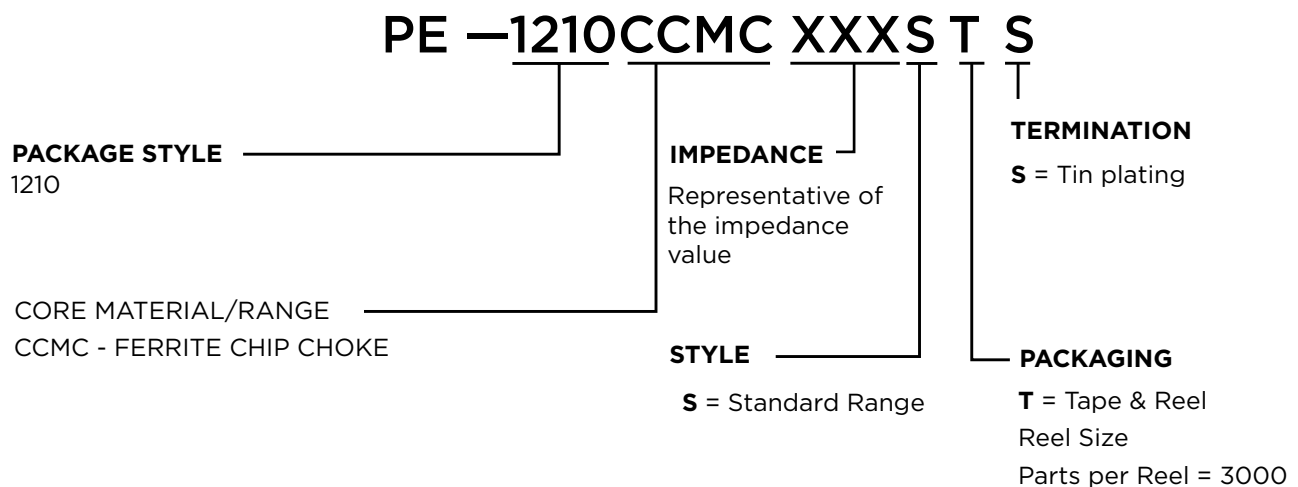

SPECIFICATION

Electrical Specifications @ 25°C

Part Number (25%)	Common Mode Impedance @ 100MHz (Ω)	DC Resistance (Ω MAX)	Rated Voltage (Vdc)	Rated Current (mA MAX)	Withstanding Voltage (Vdc)	Insulation Resistance (MΩ MIN)
PE-1210CCMC161STS	160	0.15	50	680	125	10
PE-1210CCMC271STS	270	0.25	50	640	125	10
PE-1210CCMC601STS	600	0.12	50	1000	125	10
PE-1210CCMC102STS	1000	0.35	50	480	125	10

Mechanical

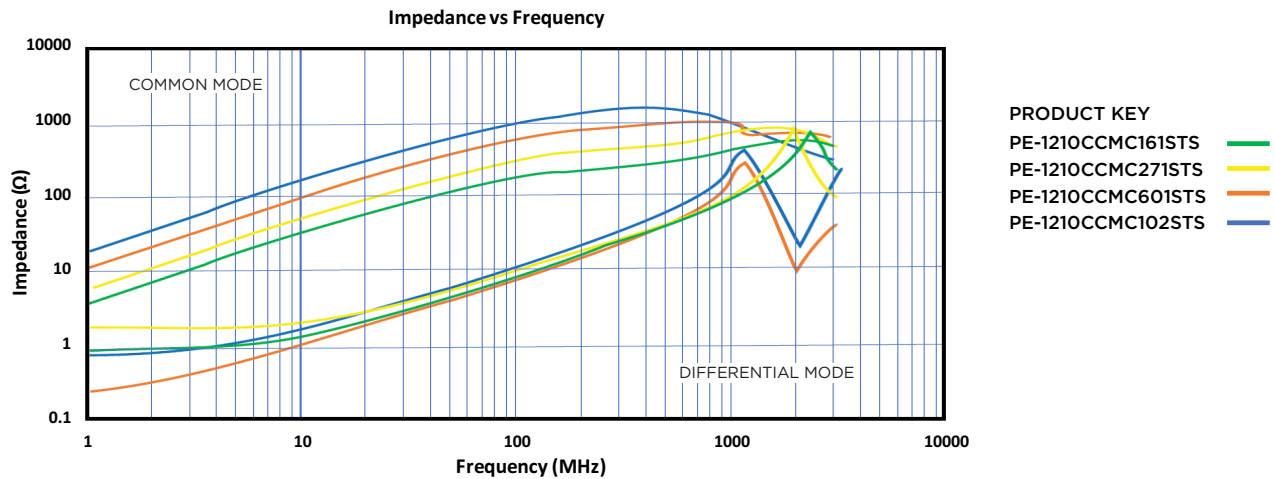
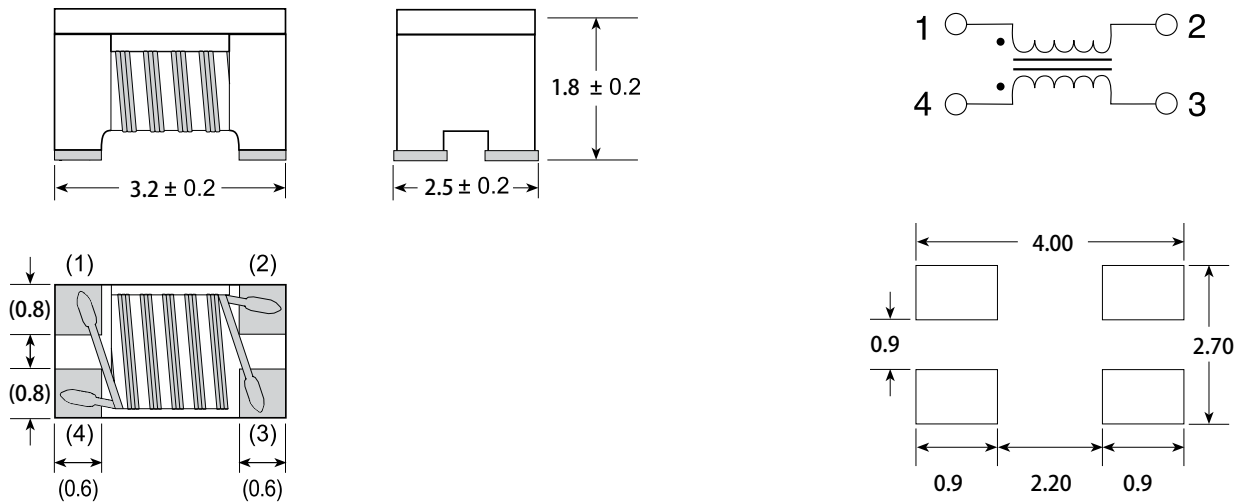

PERFORMANCE TESTING

Electrical Testing		
<p>Storage and Operating Temperature Range:</p> <p>-40° to +85°C</p>	<p>Inductors are subjected to the extremes for 48 hours.</p> <p>Then tested at 25°C</p>	<p>There shall be no deformation or change in appearance</p> <p>Inductance shall not change by more than ±5%</p> <p>Q values shall not change by more than ±10%</p> <p>There shall be no Damaged, Open or Shorted Windings</p>
<p>Thermal:</p> <p>-40° to +85°C</p>	<p>Inductors are subjected to 30 cycles for 30 minutes at each extreme.</p> <p>Then tested at 25°C</p>	
<p>Moisture Resistance</p>	<p>Inductors are subjected to 10 cycles of 24 hours at 70°C with 90 to 95% Relative Humidity</p> <p>Then tested at 25°C</p>	
<p>Operating Life</p>	<p>Inductors are subjected to 1000 hours at 85°C with 85% Relative Humidity with the rated current applied</p>	

Mechanical Testing																														
<p>Temperature Range:</p>	<p>Inductors are subjected to the following:</p> <p>Use a solder pot at 260C, with RMA Flux. Each termination is immersed in 63Sn/37Pb molten solder for 4 to 6 seconds.</p>	<p>There shall be no deformation or change in appearance</p> <p>Inductance shall not change by more than ±5%</p> <p>Q values shall not change by more than ±10%</p>																												
<p>Recommended Solder Heat Resistance Profile</p>	<table border="1"> <caption>Recommended Solder Heat Resistance Profile Data</caption> <thead> <tr> <th>TIME (SECOND)</th> <th>TEMPERATURE (C°)</th> </tr> </thead> <tbody> <tr><td>0</td><td>25</td></tr> <tr><td>25</td><td>35</td></tr> <tr><td>50</td><td>45</td></tr> <tr><td>75</td><td>75</td></tr> <tr><td>100</td><td>150</td></tr> <tr><td>125</td><td>165</td></tr> <tr><td>150</td><td>175</td></tr> <tr><td>175</td><td>190</td></tr> <tr><td>200</td><td>225</td></tr> <tr><td>225</td><td>260</td></tr> <tr><td>250</td><td>225</td></tr> <tr><td>275</td><td>180</td></tr> <tr><td>300</td><td>150</td></tr> </tbody> </table>		TIME (SECOND)	TEMPERATURE (C°)	0	25	25	35	50	45	75	75	100	150	125	165	150	175	175	190	200	225	225	260	250	225	275	180	300	150
TIME (SECOND)	TEMPERATURE (C°)																													
0	25																													
25	35																													
50	45																													
75	75																													
100	150																													
125	165																													
150	175																													
175	190																													
200	225																													
225	260																													
250	225																													
275	180																													
300	150																													

TAPE AND REEL SPECIFICATIONS

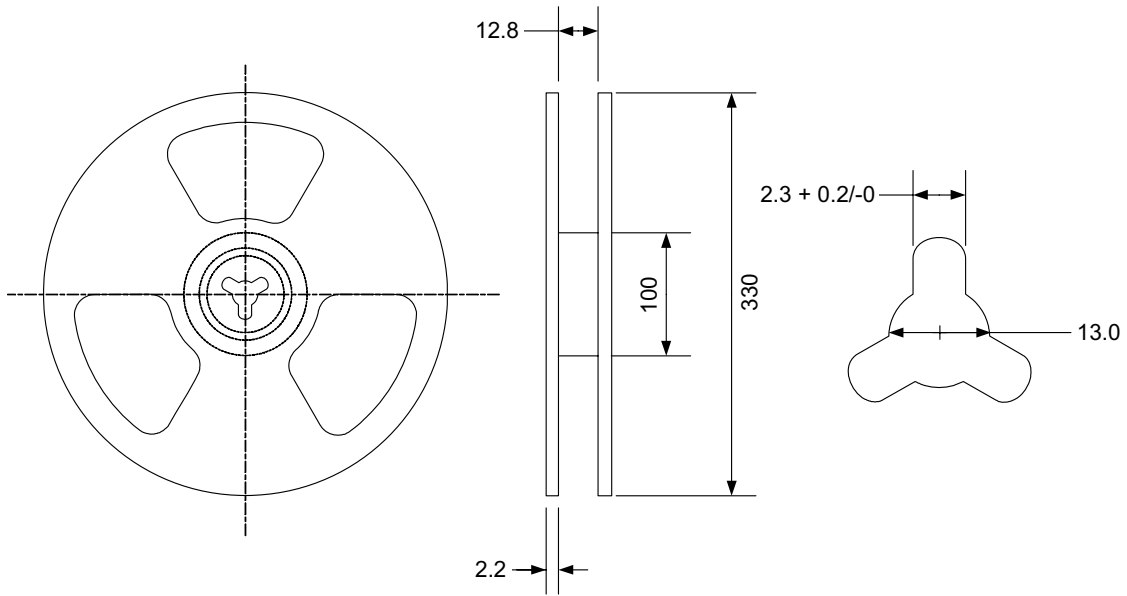

Series	Parts per Reel	Tape Dimensions (mm)					
		W	P1	P2	P3	H	T
1210CCMC	3000	12	2	8	4	2.3	0.3

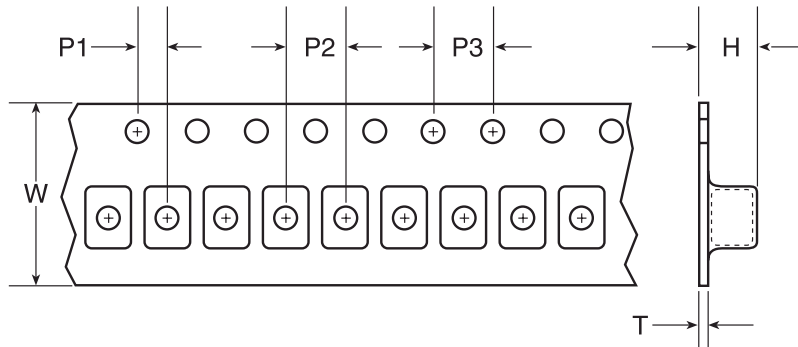

For More Information:

Americas - prodinfo@networkamericas@pulseelectronics.com | Europe - comms@pulseelectronics.com | Asia - prodinfo@networkapac@pulseelectronics.com

Performance warranty of products offered on this data sheet is limited to the parameters specified. Data is subject to change without notice. Other brand and product names mentioned herein may be trademarks or registered trademarks of their respective owners. © Copyright, 2019. Pulse Electronics, Inc. All rights reserved.