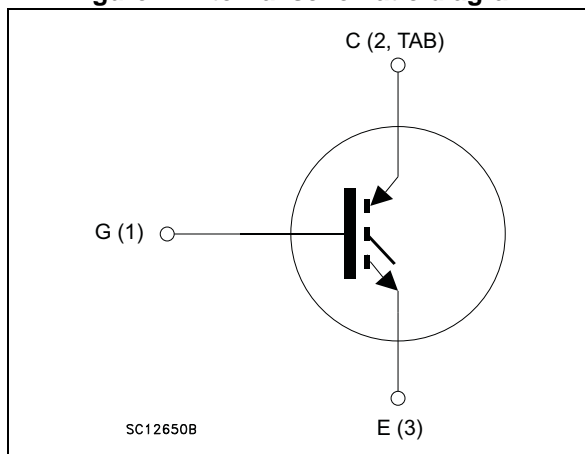

Figure 1. Internal schematic diagram



### Features

- Maximum junction temperature:  $T_J = 175\text{ °C}$
- High speed switching series
- Minimized tail current
- $V_{CE(sat)} = 1.55\text{ V (typ.) @ } I_C = 20\text{ A}$
- Tight parameters distribution
- Safe paralleling
- Low thermal resistance
- Lead free package

### Applications

- Photovoltaic inverters
- High frequency converters

### Description

These devices are IGBTs developed using an advanced proprietary trench gate and field-stop structure. The device is part of the new HB series of IGBTs, which represent an optimum compromise between conduction and switching losses to maximize the efficiency of any frequency converter. Furthermore, a slightly positive  $V_{CE(sat)}$  temperature coefficient and very tight parameter distribution result in safer paralleling operation.

Table 1. Device summary

Order codes	Marking	Package	Packaging
STGFW20H65FB	GFW20H65FB	TO-3PF	Tube
STGW20H65FB	GW20H65FB	TO-247	Tube
STGWT20H65FB	GWT20H65FB	TO-3P	Tube

# Contents

<b>1</b>	<b>Electrical ratings</b> .....	<b>3</b>
<b>2</b>	<b>Electrical characteristics</b> .....	<b>4</b>
2.1	Electrical characteristics (curve) .....	6
<b>3</b>	<b>Test circuits</b> .....	<b>12</b>
<b>4</b>	<b>Package mechanical data</b> .....	<b>13</b>
4.1	TO-3PF, STGFW20H65FB .....	13
4.2	TO-247, STGW20H65FB .....	15
4.3	TO-3P, STGWT20H65FB .....	17
<b>5</b>	<b>Revision history</b> .....	<b>19</b>

# 1 Electrical ratings

**Table 2. Absolute maximum ratings**

Symbol	Parameter	Value		Unit
		TO-247 TO-3P	TO-3PFP	
$V_{CES}$	Collector-emitter voltage ( $V_{GE} = 0$ )	650		V
$I_C$	Continuous collector current at $T_C = 25\text{ °C}$	40		A
$I_C$	Continuous collector current at $T_C = 100\text{ °C}$	20		A
$I_{CP}^{(1)}$	Pulsed collector current	80		A
$V_{GE}$	Gate-emitter voltage	$\pm 20$		V
$P_{TOT}$	Total dissipation at $T_C = 25\text{ °C}$	168	52	W
$T_{STG}$	Storage temperature range	- 55 to 150		°C
$T_J$	Operating junction temperature	- 55 to 175		°C

1. Pulse width limited by maximum junction temperature.

**Table 3. Thermal data**

Symbol	Parameter	Value		Unit
		TO-3PF	TO-247 TO-3P	
$R_{thJC}$	Thermal resistance junction-case	2.9	0.9	°C/W
$R_{thJA}$	Thermal resistance junction-ambient	50		°C/W

## 2 Electrical characteristics

$T_J = 25\text{ °C}$  unless otherwise specified.

**Table 4. Static characteristics**

Symbol	Parameter	Test conditions	Min.	Typ.	Max.	Unit
$V_{(BR)CES}$	Collector-emitter breakdown voltage ( $V_{GE} = 0$ )	$I_C = 2\text{ mA}$	650			V
$V_{CE(sat)}$	Collector-emitter saturation voltage	$V_{GE} = 15\text{ V}, I_C = 20\text{ A}$		1.55	2	V
		$V_{GE} = 15\text{ V}, I_C = 20\text{ A}$ $T_J = 125\text{ °C}$		1.65		
		$V_{GE} = 15\text{ V}, I_C = 20\text{ A}$ $T_J = 175\text{ °C}$		1.75		
$V_{GE(th)}$	Gate threshold voltage	$V_{CE} = V_{GE}, I_C = 1\text{ mA}$	5	6	7	V
$I_{CES}$	Collector cut-off current ( $V_{GE} = 0$ )	$V_{CE} = 650\text{ V}$			25	$\mu\text{A}$
$I_{GES}$	Gate-emitter leakage current ( $V_{CE} = 0$ )	$V_{GE} = \pm 20\text{ V}$			250	nA

**Table 5. Dynamic characteristics**

Symbol	Parameter	Test conditions	Min.	Typ.	Max.	Unit
$C_{ies}$	Input capacitance	$V_{CE} = 25\text{ V}, f = 1\text{ MHz},$ $V_{GE} = 0$	-	2764	-	pF
$C_{oes}$	Output capacitance		-	80	-	pF
$C_{res}$	Reverse transfer capacitance		-	60	-	pF
$Q_g$	Total gate charge	$V_{CC} = 520\text{ V}, I_C = 20\text{ A},$ $V_{GE} = 15\text{ V},$ see <a href="#">Figure 27</a>	-	120	-	nC
$Q_{ge}$	Gate-emitter charge		-	20	-	nC
$Q_{gc}$	Gate-collector charge		-	50	-	nC

Table 6. Switching characteristics (inductive load)

Symbol	Parameter	Test conditions	Min.	Typ.	Max.	Unit
$t_{d(on)}$	Turn-on delay time	$V_{CE} = 400\text{ V}$ , $I_C = 20\text{ A}$ , $R_G = 10\ \Omega$ , $V_{GE} = 15\text{ V}$ , see <a href="#">Figure 26</a>	-	30	-	ns
$t_r$	Current rise time		-	11	-	ns
$(di/dt)_{on}$	Turn-on current slope		-	1400	-	A/ $\mu$ s
$t_{d(off)}$	Turn-off delay time		-	139	-	ns
$t_f$	Current fall time		-	20	-	ns
$E_{on}^{(1)}$	Turn-on switching losses		-	77	-	$\mu$ J
$E_{off}^{(2)}$	Turn-off switching losses		-	170	-	$\mu$ J
$E_{ts}$	Total switching losses		-	247	-	$\mu$ J
$t_{d(on)}$	Turn-on delay time	$V_{CE} = 400\text{ V}$ , $I_C = 20\text{ A}$ , $R_G = 10\ \Omega$ , $V_{GE} = 15\text{ V}$ , $T_J = 175\text{ }^\circ\text{C}$ , see <a href="#">Figure 26</a>	-	29	-	ns
$t_r$	Current rise time		-	12	-	ns
$(di/dt)_{on}$	Turn-on current slope		-	1352	-	A/ $\mu$ s
$t_{d(off)}$	Turn-off delay time		-	147	-	ns
$t_f$	Current fall time		-	38	-	ns
$E_{on}^{(1)}$	Turn-on switching losses		-	88	-	$\mu$ J
$E_{off}^{(2)}$	Turn-off switching losses		-	353	-	$\mu$ J
$E_{ts}$	Total switching losses		-	441	-	$\mu$ J

1. Energy losses include reverse recovery of the external diode. Turn-on times and energy have been measured applying as freewheeling an external SiC diode STPSC206W
2. Turn-off losses include also the tail of the collector current.

## 2.1 Electrical characteristics (curve)

Figure 2. Output characteristics ( $T_J = 25^\circ\text{C}$ )

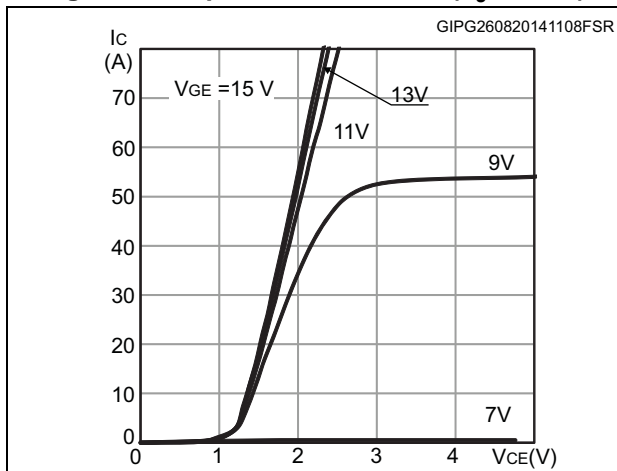

Figure 3. Output characteristics ( $T_J = 175^\circ\text{C}$ )

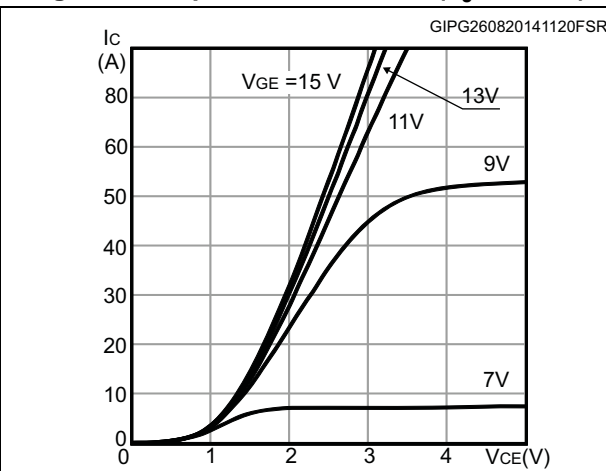

Figure 4. Transfer characteristics

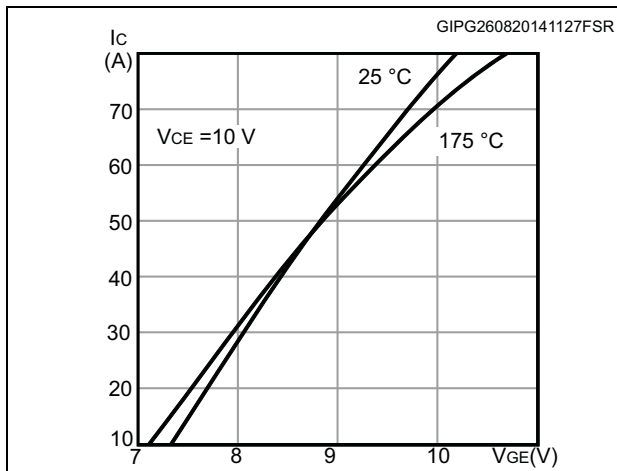

Figure 5. Collector current vs. case temperature for TO-247 and TO-3P

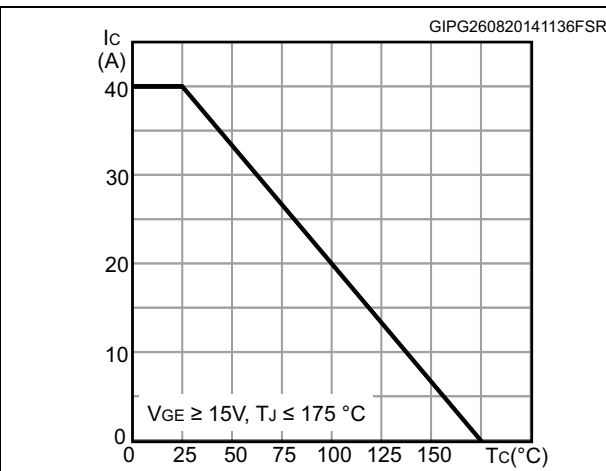

Figure 6. Collector current vs. case temperature for TO-3PF

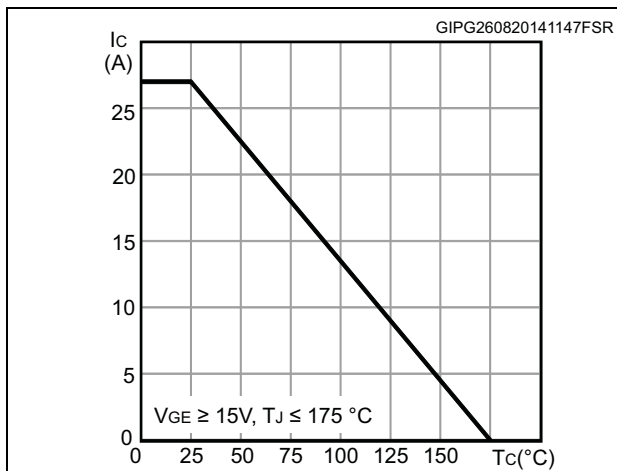

Figure 7.  $V_{CE(sat)}$  vs. junction temperature

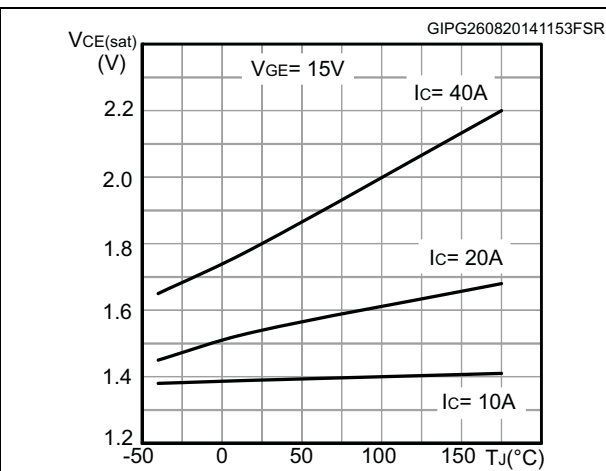

Figure 8. Power dissipation vs. case temperature for TO-247 and TO-3P

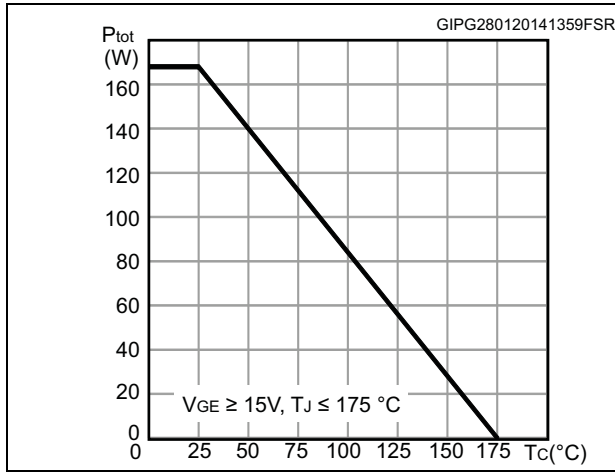

Figure 9. Power dissipation vs. case temperature for TO-3PF

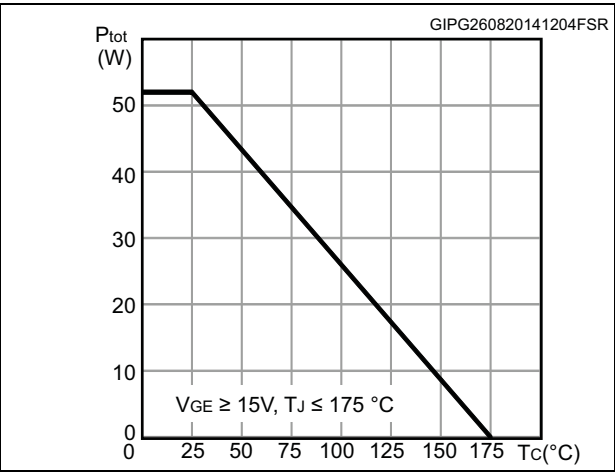

Figure 10. Forward bias safe operating area for TO-247 and TO-3P

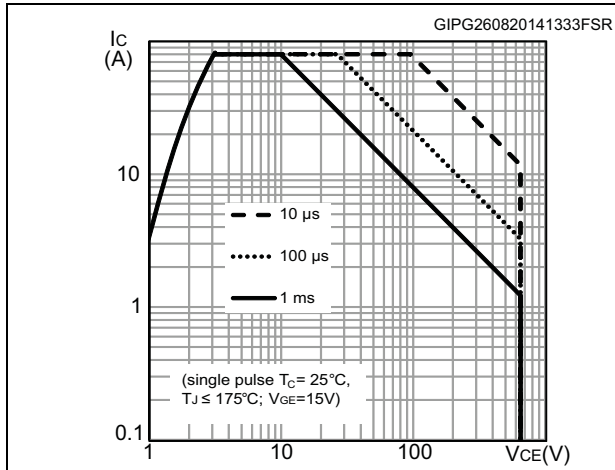

Figure 11. Forward bias safe operating area for TO-3PF

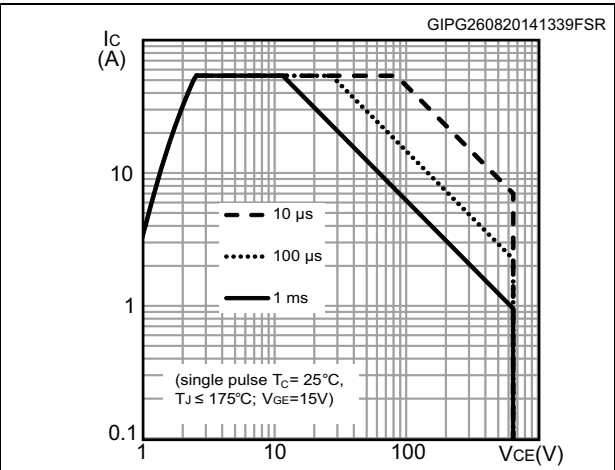

Figure 12. Collector current vs. switching frequency for TO-247 and TO-3P

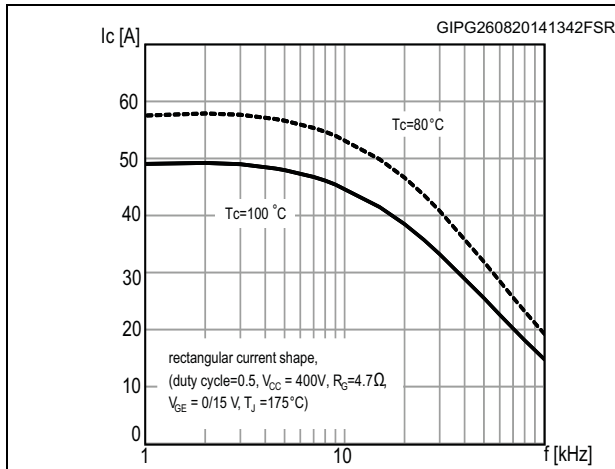

Figure 13. Collector current vs. switching frequency for TO-3PF

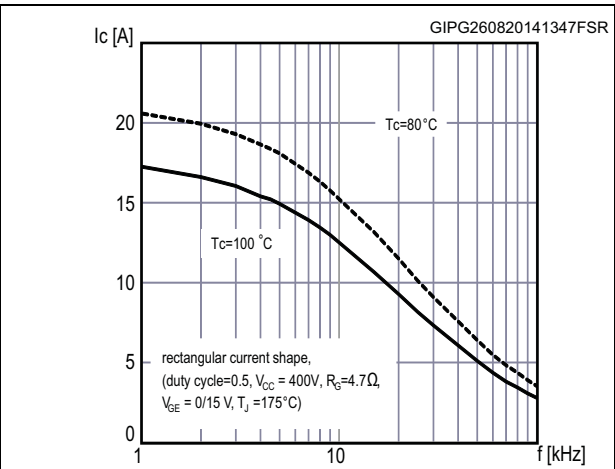

Figure 14. Normalized  $V_{GE(th)}$  vs. junction temperature

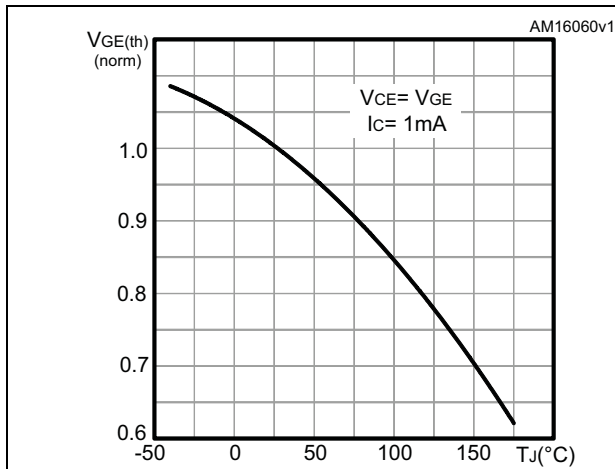

Figure 15. Normalized  $V_{(BR)CES}$  vs. junction temperature

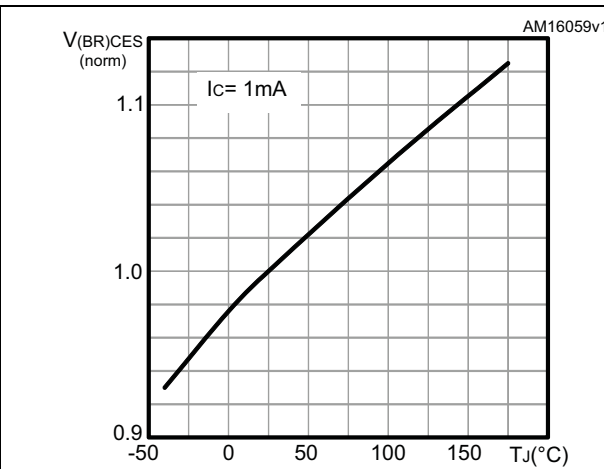

Figure 16. Switching losses vs temperature

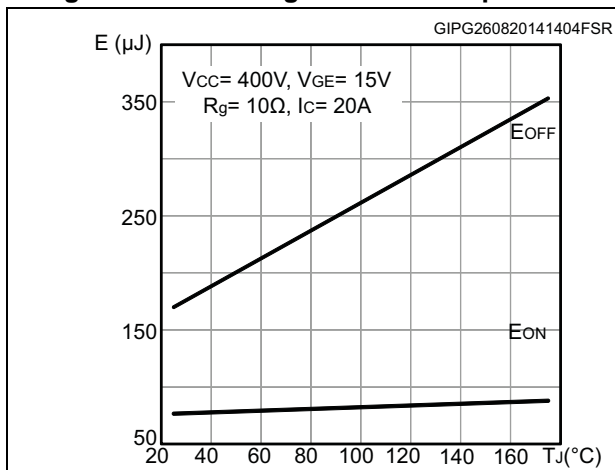

Figure 17. Switching losses vs gate resistance

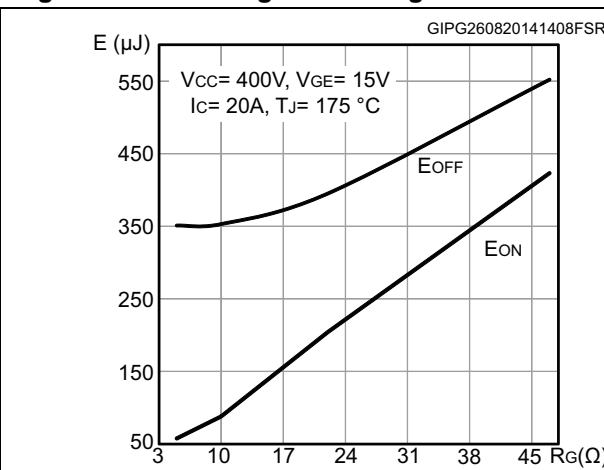

Figure 18. Switching losses vs collector current

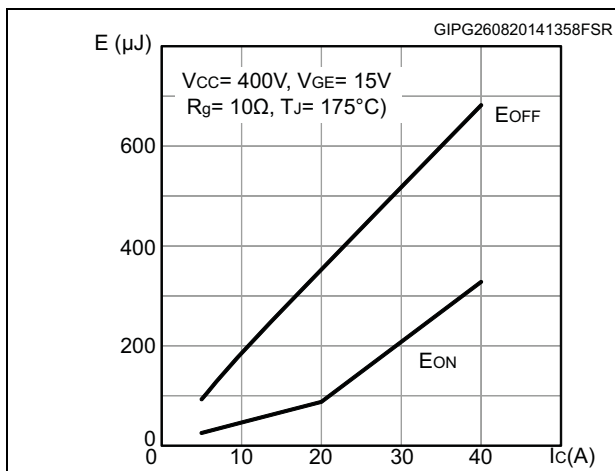

Figure 19. Switching losses vs collector emitter voltage

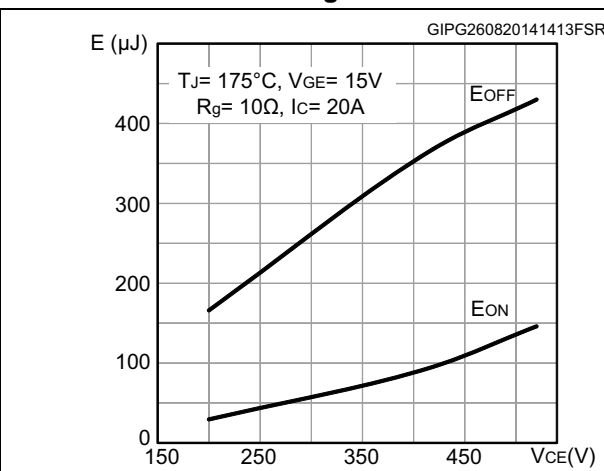



Figure 20. Switching times vs collector current

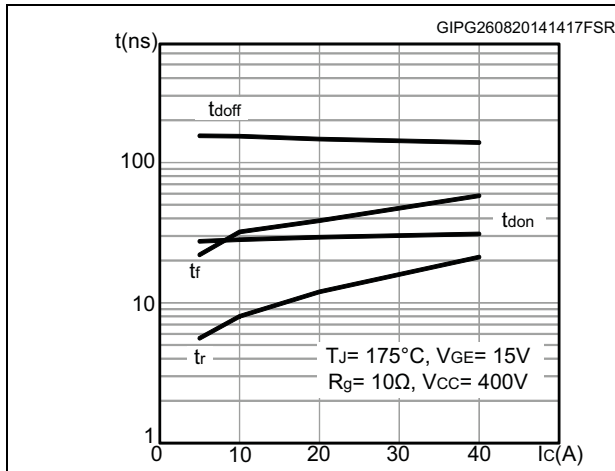

Figure 21. Switching times vs gate resistance

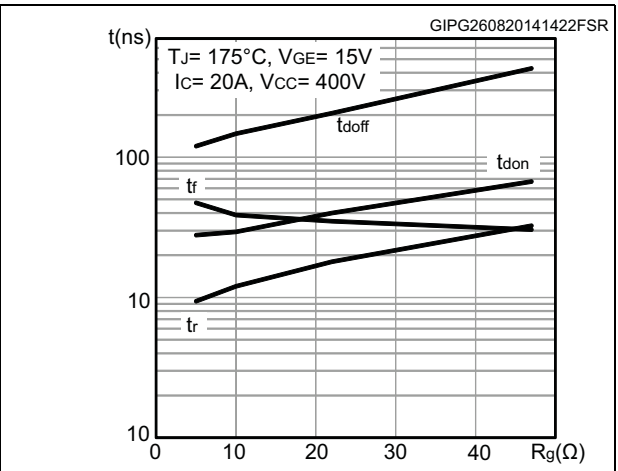

Figure 22. Capacitance variations

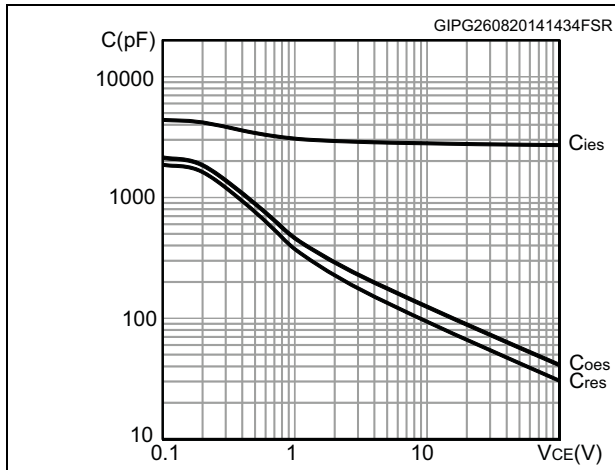

Figure 23. Gate charge vs. gate-emitter voltage

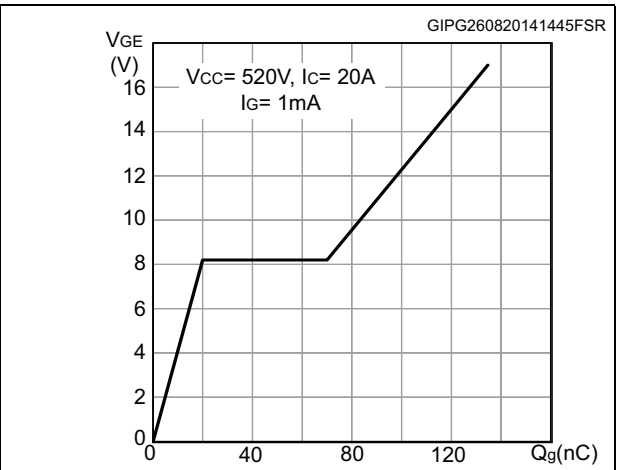

Figure 24. Thermal impedance for TO-247 and TO-3P

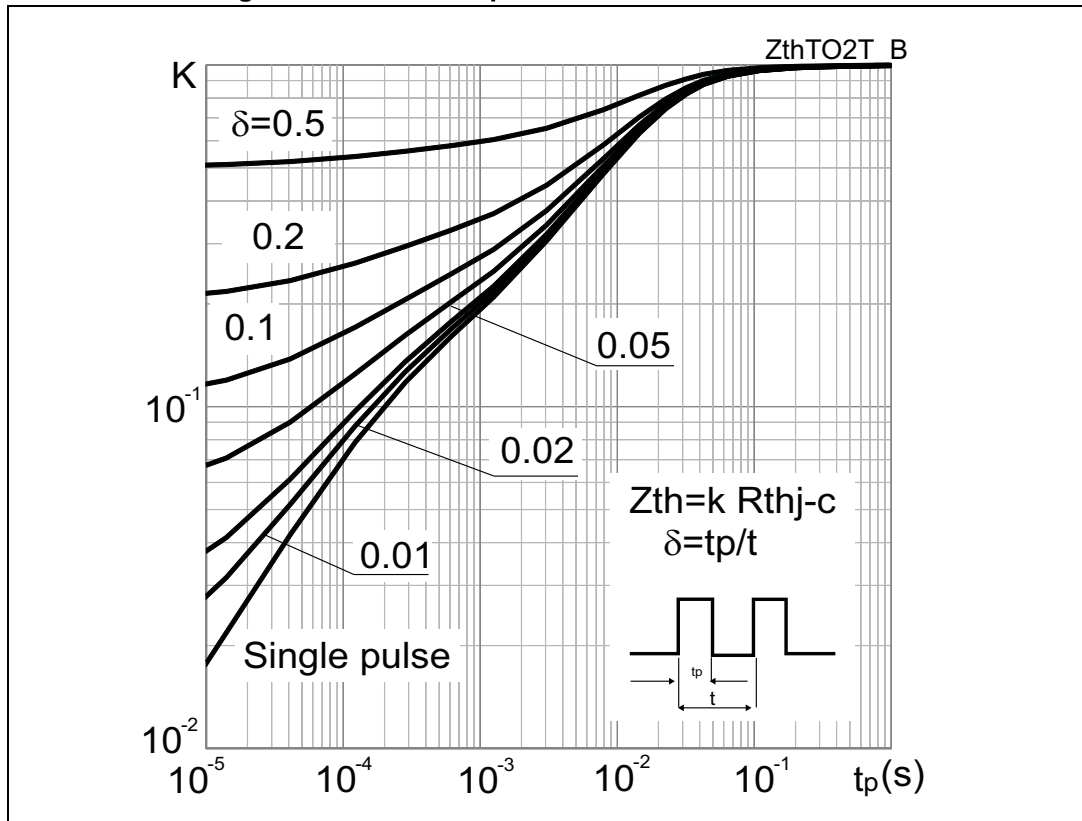
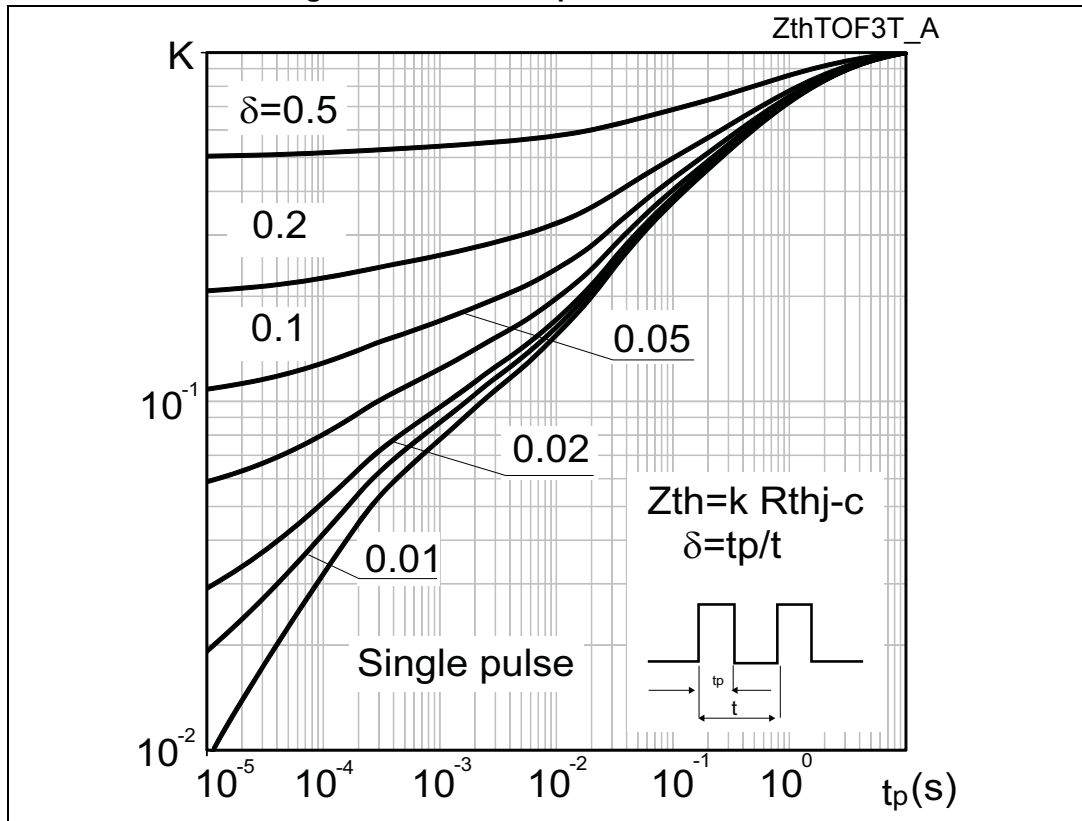

Figure 25. Thermal impedance for TO-3PF



### 3 Test circuits

Figure 26. Test circuit for inductive load switching



Figure 27. Gate charge test circuit

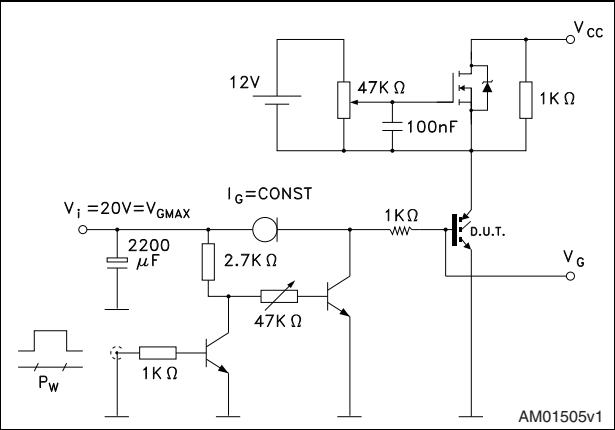
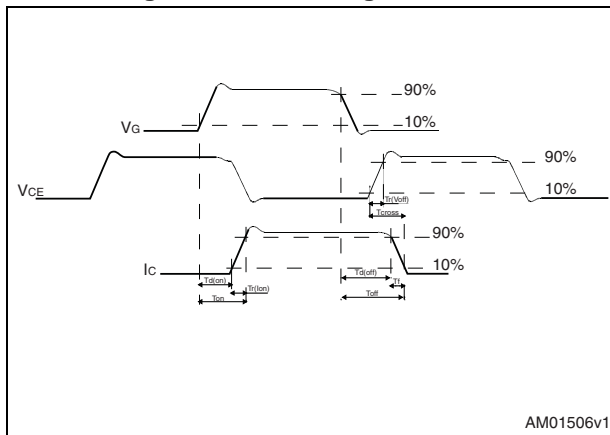

Figure 28. Switching waveform



## 4 Package mechanical data

In order to meet environmental requirements, ST offers these devices in different grades of ECOPACK® packages, depending on their level of environmental compliance. ECOPACK® specifications, grade definitions and product status are available at: [www.st.com](http://www.st.com). ECOPACK is an ST trademark.

### 4.1 TO-3PF, STGFW20H65FB

Figure 29. TO-3PF drawing

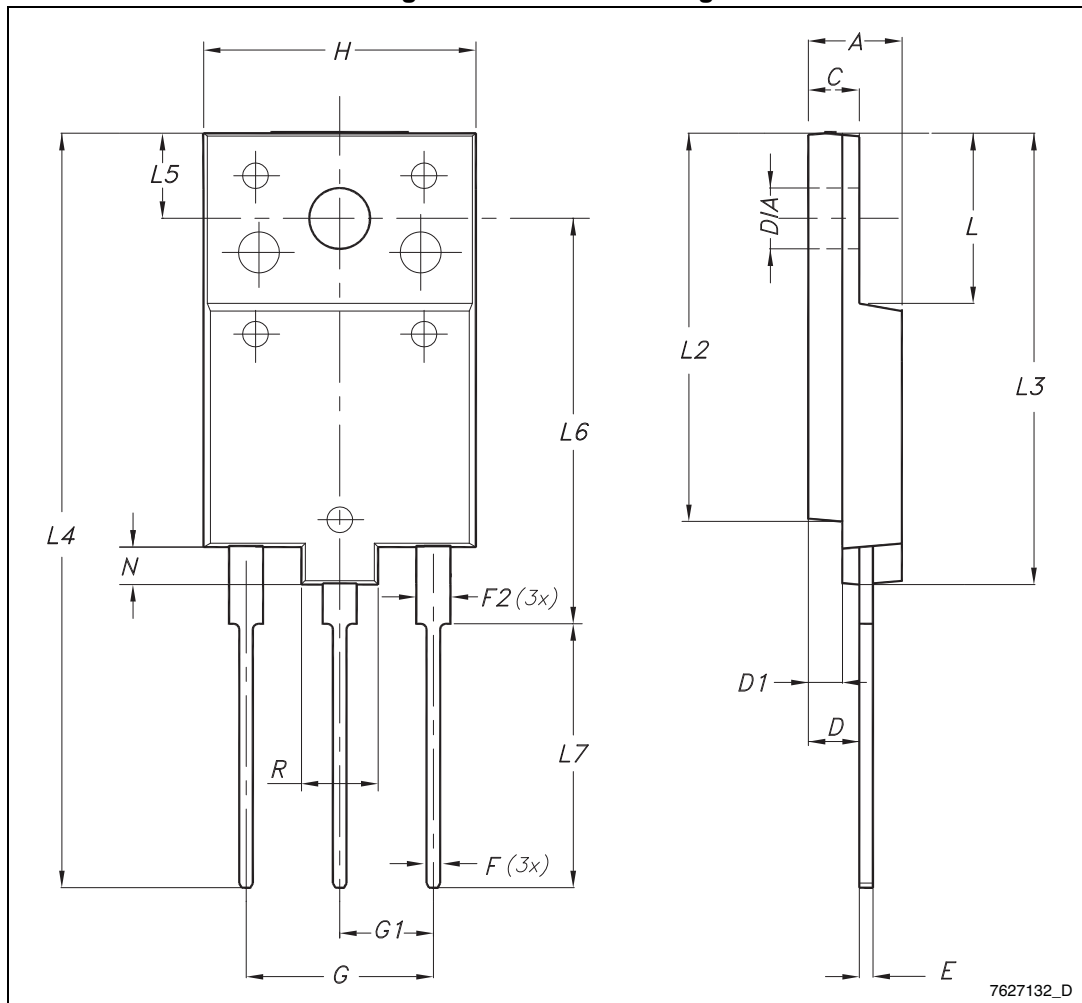

7627132\_D

Table 7. TO-3PF mechanical data

Dim.	mm		
	Min.	Typ.	Max.
A	5.30		5.70
C	2.80		3.20
D	3.10		3.50
D1	1.80		2.20
E	0.80		1.10
F	0.65		0.95
F2	1.80		2.20
G	10.30		11.50
G1		5.45	
H	15.30		15.70
L	9.80	10	10.20
L2	22.80		23.20
L3	26.30		26.70
L4	43.20		44.40
L5	4.30		4.70
L6	24.30		24.70
L7	14.60		15
N	1.80		2.20
R	3.80		4.20
Dia	3.40		3.80

### 4.2 TO-247, STGW20H65FB

Figure 30. TO-247 drawing

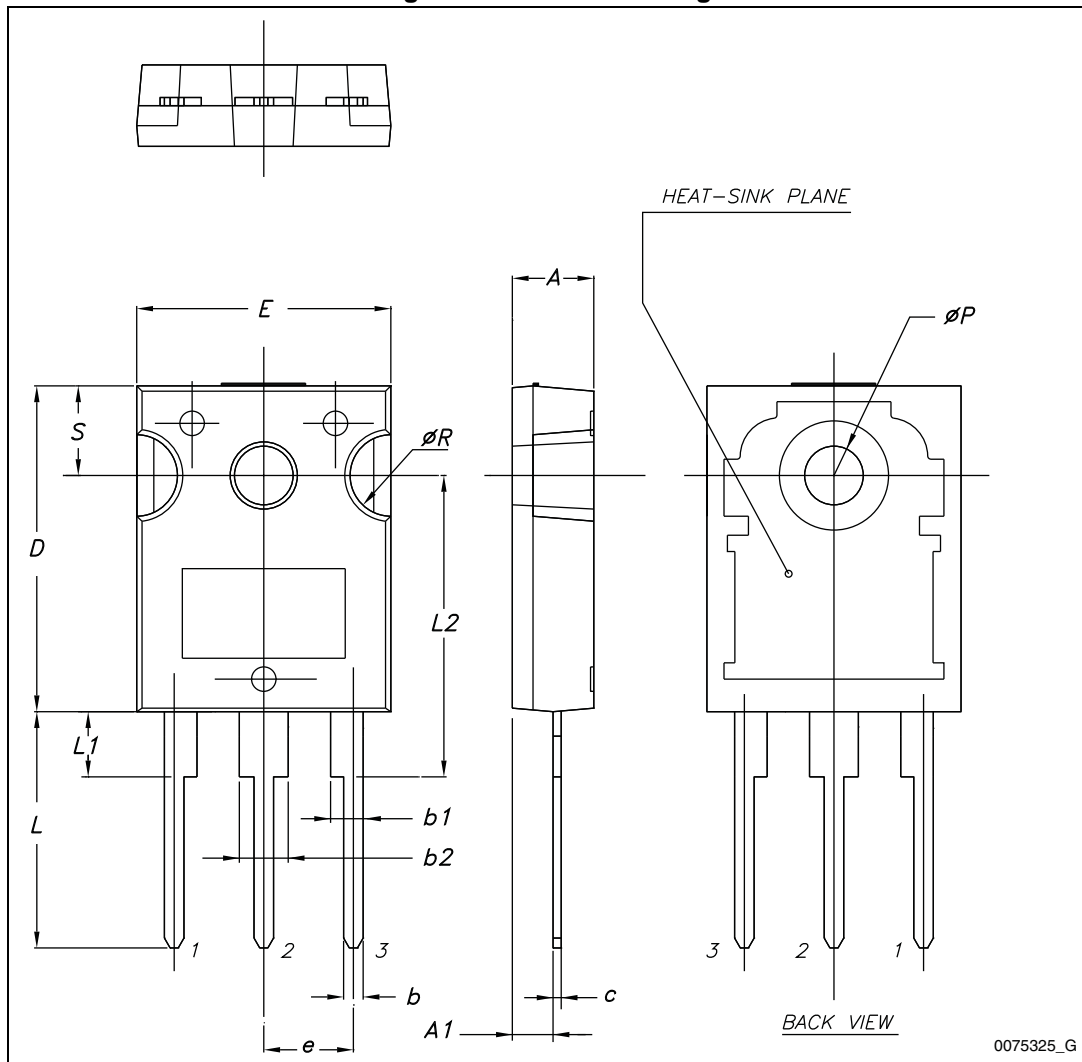

Table 8. TO-247 mechanical data

Dim.	mm.		
	Min.	Typ.	Max.
A	4.85		5.15
A1	2.20		2.60
b	1.0		1.40
b1	2.0		2.40
b2	3.0		3.40
c	0.40		0.80
D	19.85		20.15
E	15.45		15.75
e	5.30	5.45	5.60
L	14.20		14.80
L1	3.70		4.30
L2		18.50	
ØP	3.55		3.65
ØR	4.50		5.50
S	5.30	5.50	5.70



4.3 TO-3P, STGWT20H65FB

Figure 31. TO-3P drawing

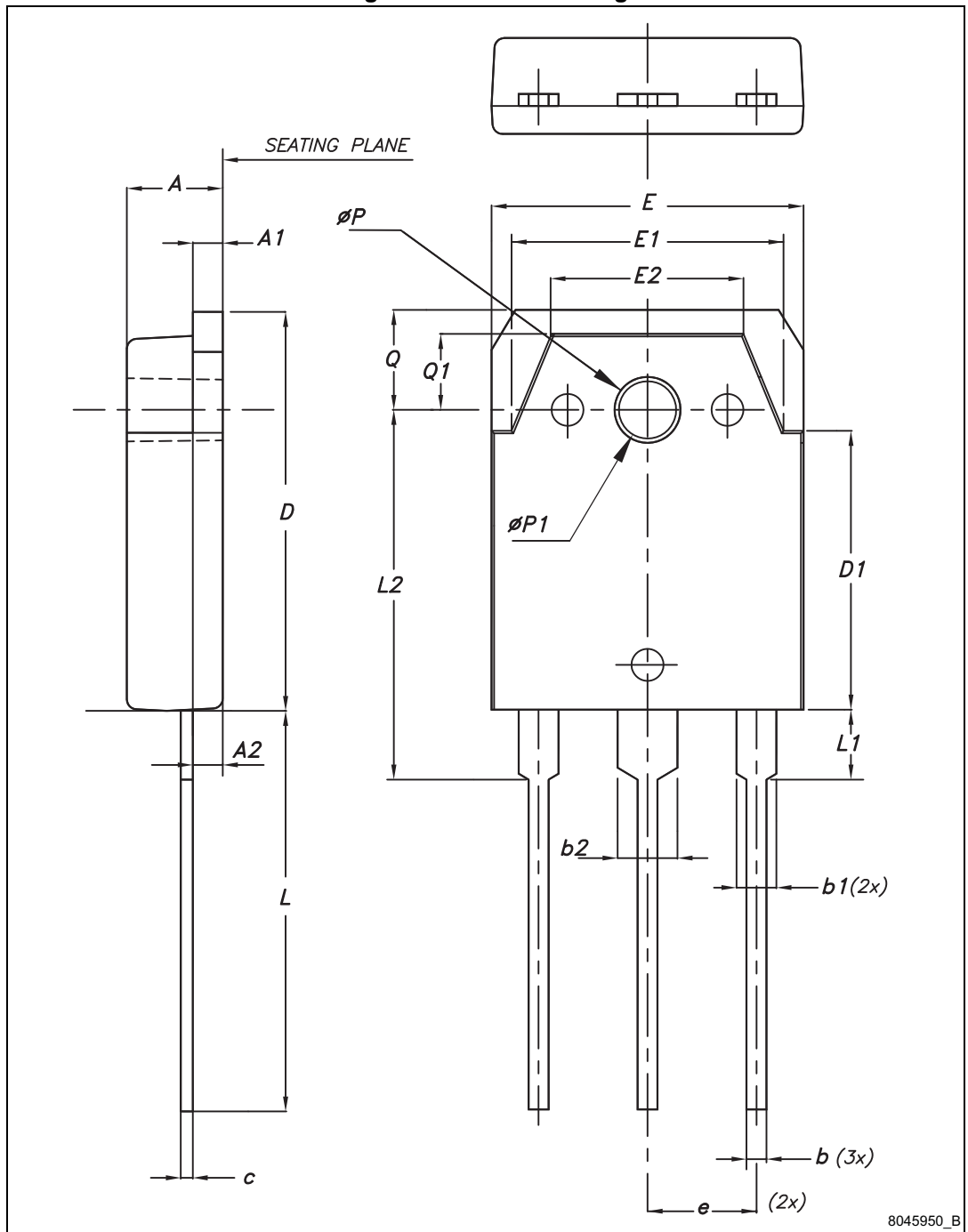

Table 9. TO-3P mechanical data

Dim.	mm		
	Min.	Typ.	Max.
A	4.60	4.80	5
A1	1.45	1.50	1.65
A2	1.20	1.40	1.60
b	0.80	1.00	1.20
b1	1.80	2.00	2.20
b2	2.80	3.00	3.20
c	0.55	0.60	0.75
D	19.70	19.90	20.10
D1	13.70	13.90	14.10
E	15.40	15.60	15.80
E1	13.40	13.60	13.80
E2	9.40	9.60	9.90
e	5.15	5.45	5.75
L	19.80	20	20.20
L1	3.30	3.50	3.70
L2	18.20	18.40	18.60
øP	3.30	3.40	3.50
øP1	3.10	3.20	3.30
Q	4.80	5	5.20
Q1	3.60	3.80	4

## 5 Revision history

Table 10. Document revision history

Date	Revision	Changes
28-Aug-2014	1	Initial release.

**IMPORTANT NOTICE – PLEASE READ CAREFULLY**

STMicroelectronics NV and its subsidiaries ("ST") reserve the right to make changes, corrections, enhancements, modifications, and improvements to ST products and/or to this document at any time without notice. Purchasers should obtain the latest relevant information on ST products before placing orders. ST products are sold pursuant to ST's terms and conditions of sale in place at the time of order acknowledgement.

Purchasers are solely responsible for the choice, selection, and use of ST products and ST assumes no liability for application assistance or the design of Purchasers' products.

No license, express or implied, to any intellectual property right is granted by ST herein.

Resale of ST products with provisions different from the information set forth herein shall void any warranty granted by ST for such product.

ST and the ST logo are trademarks of ST. All other product or service names are the property of their respective owners.

Information in this document supersedes and replaces information previously supplied in any prior versions of this document.

© 2014 STMicroelectronics – All rights reserved