

**Sockets & Accessories, R10 Relays**

- Sockets for 2 - 6 pole relays
- Solder, PCB or screw terminal sockets
- Choice of grounding provision on sockets
- Hold down springs
- Plates and brackets permit various mounting options



**Approvals**

UL E59244, CSA LR15734  
Technical data of approved types on request

**Technical Data**

Socket contact material	Spring brass, tin plated
Socket body material	
2 and 4 pole models	Polyester
6 and 8 pole models	Phenolic
Maximum current	10A
Voltage drop	30mV max. at 10A
Dielectric strength	1,000Vrms
Insulation resistance	10 <sup>9</sup> megΩ

**Solder and PC terminal sockets**

Rugged, molded socket body retains floating terminals of either solder or printed circuit pin configuration. PC terminal sockets are offered with pins in either 0.1" (2.54mm) grid or in-line arrangement.

**Grounding provisions**

Pre-installed on sockets

Not for use at 5A AC and above.

Grounding Strip: Mounting stud of relay contacts grounding strip. Grounding strip is grounded with screw or rivet through round hole in socket.

Grounding Terminal (PC sockets only): Mounting stud of relay contacts ground terminal through square hole in socket.

**Strip**

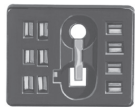

**Terminal**



**Ordering Code**



Product Code	Poles	Terminal type	Grounding provision	Part number
27E125	2	solder terminals	strip	1393143-8
27E126	4			1393143-9
27E127	6			1-1393143-0
27E162	2		none	1-1393143-6
27E163	4			1-1393143-7
27E164	6			1-1393143-8
27E128	2	PCB terminals, .180"	strip	1-1393143-1
27E129	4	(4.57mm) long,		1-1393143-2
27E130	6	staggered layout		1-1393143-3
27E212	2		none	2-1393143-4
27E213	4			2-1393143-5
27E271	6			3-1393143-1
27E193	2		terminal	2-1393143-1
27E194	4			2-1393143-2
27E636	2	PCB terminals, 210"	strip	5-1393143-0
27E637	4	(5.33mm) long,		5-1393143-1
		staggered layout		
27E342	2	PCB terminals, .180"	none	3-1393143-6
27E629	4	(4.57mm) long,		4-1393143-8
27E630	6	in-line layout		4-1393143-9

All accessories must be ordered separately.

**Caution:**

Printed circuit sockets are manufactured with "floating" (loose) terminals. This permits them to align with holes in the circuit board and with the relay terminals. During the mounting and soldering of the socket, vertical float should be eliminated and the terminals seated on the board. (This may be accomplished by inserting a dummy relay in the socket.) Failure to eliminate float may cause fracture of the solder joint or separation of the copper conductor from the printed circuit board when a relay is inserted in the socket after soldering.

**Sockets & Accessories, R10 Relays** (Continued)

**Dimensions**

Solder and PC terminal sockets

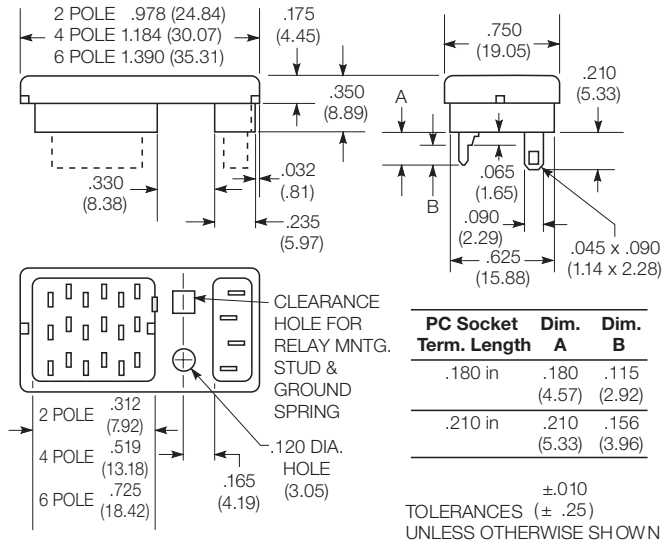

**PCB layout**

Sockets with staggered PC terminals

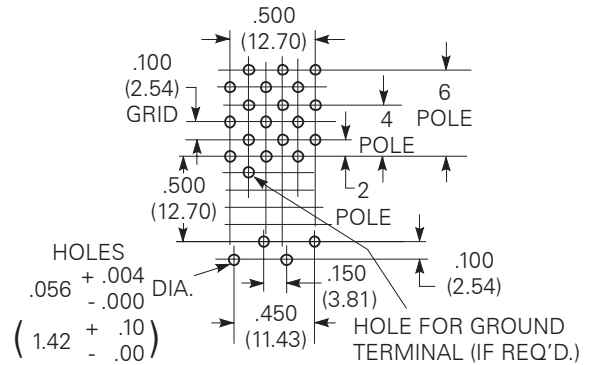

**PCB layout (top view)**

Sockets with solder terminals

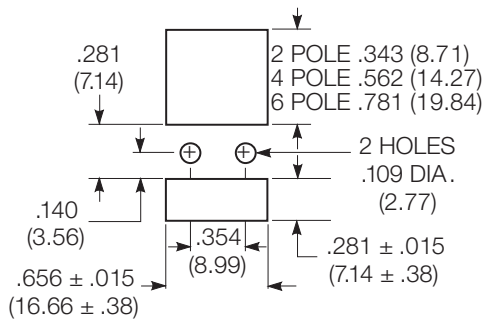

Sockets with inline PC terminals

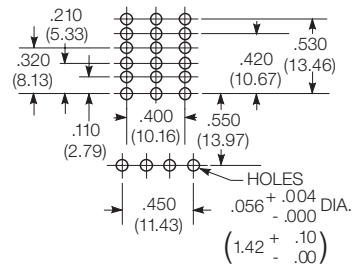

**Sockets & Accessories, R10 Relays (Continued)**

**Ordering Code**

Product Code	Poles	Terminal type	Mount type	Grounding provision	Part number
27E317	2	solder	bracket	strip	3-1393143-4
27E152	4				1-1393143-5
27E446	2	solder	flange	strip	4-1393143-1
27E447	4				4-1393143-2
27E448	6				4-1393143-3
27E460	2	screw	track/ chassis	none	1393837-1
27E461	4				4-1393143-4
27E462	6				4-1393143-5

All accessories must be ordered separately.

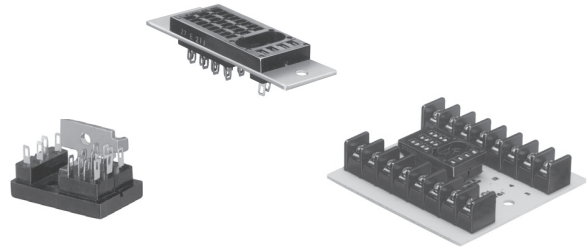

**Dimensions**

Bracket Mount socket 27E317 and 27E152  
Allows solder terminal relay to mount flat on a chassis.

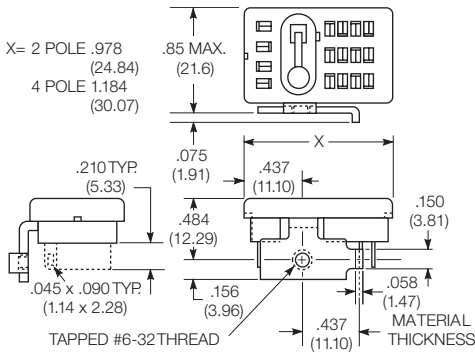

Flange mount socket 27E446, 27E447, 27E448  
Solder terminal socket with tin-plated terminals and grounding strip pre-assembled on .065" (1.65mm) steel mounting plate. Requires only one chassis cutout.

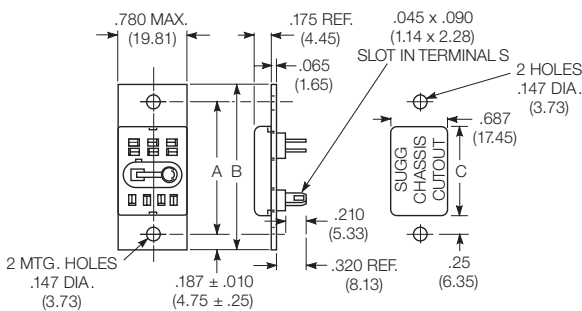

Track mount sockets 27E460, 27E461, 27E462  
Provides front wiring, screw terminal connections for R10 family relays. No grounding provision.

2 pole terminal wiring code

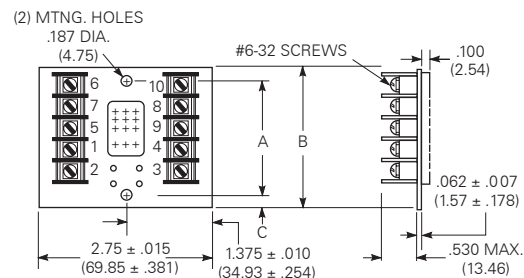

Socket	Poles	Dim A	Dim B	Dim C
27E446	2	1.437 (36.50)	1.822 (46.27)	.937 (23.80)
27E447	4	1.687 (42.85)	2.072 (52.63)	1.125 (28.58)
27E448	6	1.875 (47.63)	2.260 (57.40)	1.343 (34.11)

4 pole terminal wiring code

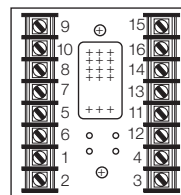

Suggested track mounting

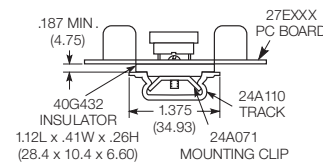

6 pole terminal wiring code

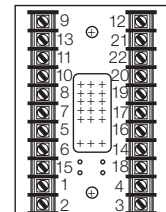

Suggested chassis mounting

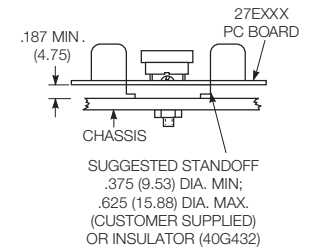

**Sockets & Accessories, R10 Relays** (Continued)

**Ordering Code**

Product Code	Description	Part number
20C249	Hold down spring for 2 pole R10 relays	3-1393159-5
20C250	Hold down spring for 4 pole R10 relays	3-1393159-6
20C251	Hold down spring for 6 pole R10 relays	3-1393159-7
20C266	Hold down spring for 8 pole R10 relays	4-1393159-1
20C259	Hold down strap for R10 relays in PC sockets	4-1393159-0
20C300	Hold down spring for 2 pole R10S relays	4-1393159-4
20C301	Hold down spring for 4 pole R10S relays	4-1393159-5
37D645	Mounting strip - accepts 10 relays or sockets	7-1393143-3
24A110	Mounting track	1419111-6
24A071	Steel mounting clip with #6-32 screw - use with 27E46_ sockets on 24A110 track	1419111-5
40G432	Plastic insulator - use with use with 27E46_ sockets on chassis or with 24A071 clip on 24A110 track	9-1393159-5

All accessories must be ordered separately.

Hold down spring



Hold down strap (PC sockets only)



**Dimensions**

**37D645 – Mounting Strip**

Strip of .060" (1.52mm) aluminum contains ten pre-punched, breakaway mounting plates. Each plate accommodates a 2, 4, 6 or 8 pole solder terminal R10 relay or socket to facilitate chassis- or rack mounting.

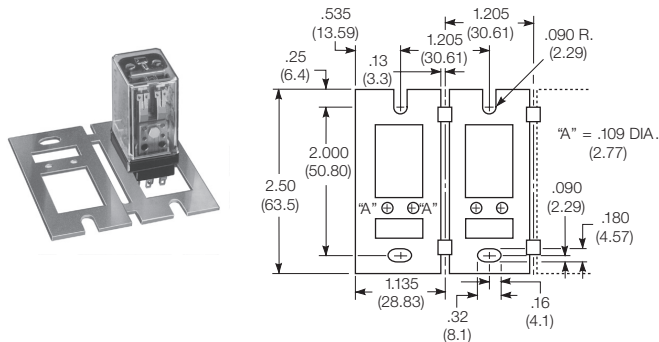

**24A110 – Mounting track**

Mounting track is designed to accept snap-mount sockets, as well as other P&B screw terminal sockets. Track is made of lightweight, sturdy extruded aluminum and is shipped in three-foot (914cm) lengths with mounting holes on six-inch (152mm) centers. Track can be cut to shorter lengths or used end-to-end.

