

Trench gate field-stop IGBT, V series 600 V, 40 A very high speed

Datasheet - production data

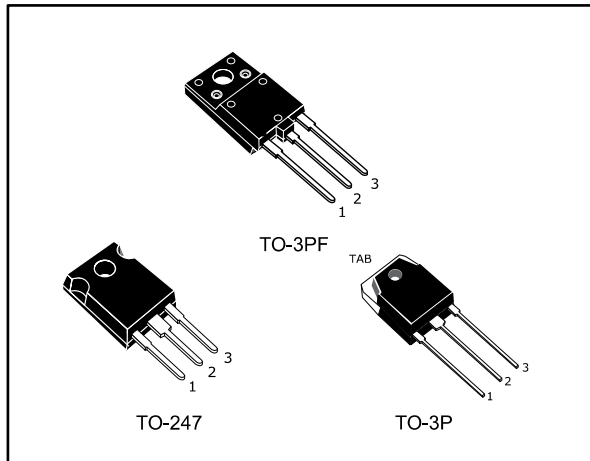
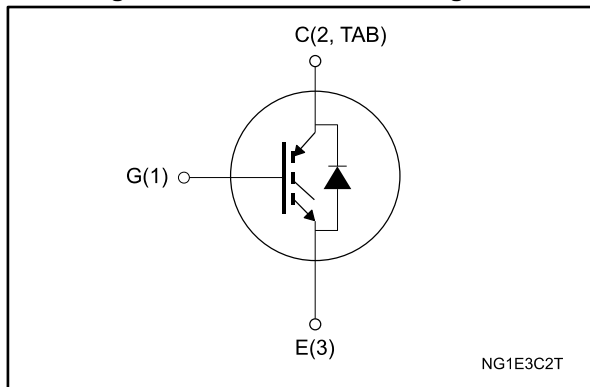

Figure 1: Internal schematic diagram



Features

- Maximum junction temperature: $T_J = 175\text{ }^\circ\text{C}$
- Tail-less switching off
- $V_{CE(sat)} = 1.8\text{ V (typ.) @ } I_c = 40\text{ A}$
- Tight parameters distribution
- Safe paralleling
- Low thermal resistance
- Very fast soft recovery antiparallel diode

Applications

- Photovoltaic inverters
- Uninterruptible power supply
- Welding
- Power factor correction
- Very high frequency converters

Description

This device is an IGBT developed using an advanced proprietary trench gate field-stop structure. The device is part of the V series IGBTs, which represent an optimum compromise between conduction and switching losses to maximize the efficiency of very high frequency converters. Furthermore, the positive $V_{CE(sat)}$ temperature coefficient and very tight parameter distribution result in safer paralleling operation.

Table 1: Device summary

Order code	Marking	Package	Packing
STGFW40V60DF	GFW40V60DF	TO-3PF	Tube
STGW40V60DF	GW40V60DF	TO-247	Tube
STGWT40V60DF	GWT40V60DF	TO-3P	Tube

Contents

1	Electrical ratings	3
2	Electrical characteristics	4
	2.1 Electrical characteristics curves	6
3	Test circuits	13
4	Package information	14
	4.1 TO-3PF package information	14
	4.2 TO-247 package information	16
	4.3 TO-3P package information	18
5	Revision history	20

1 Electrical ratings

Table 2: Absolute maximum ratings

Symbol	Parameter	Value		Unit
		TO-247 TO-3P	TO-3PF	
V _{CES}	Collector-emitter voltage (V _{GE} = 0 V)	600		V
I _C	Continuous collector current at T _C = 25 °C	80		A
	Continuous collector current at T _C = 100 °C	40		A
I _{CP} ⁽¹⁾	Pulsed collector current	160		A
V _{GE}	Gate-emitter voltage	±20		V
I _F	Continuous forward current at T _C = 25 °C	80		A
	Continuous forward current at T _C = 100 °C	40		A
I _{FP} ⁽¹⁾	Pulsed forward current	160		A
P _{TOT}	Total dissipation at T _C = 25 °C	283	62.5	W
V _{ISO}	Insulation withstand voltage (RMS) from all three leads to external heat sink (t = 1 s, T _C = 25 °C)	3.5		kV
T _{STG}	Storage temperature range	-55 to 150		°C
T _J	Operating junction temperature range	-55 to 175		°C

Notes:

⁽¹⁾Pulse width is limited by maximum junction temperature.

Table 3: Thermal data

Symbol	Parameter	Value		Unit
		TO-247 TO-3P	TO-3PF	
R _{thJC}	Thermal resistance junction-case IGBT	0.53	2.4	°C/W
R _{thJC}	Thermal resistance junction-case diode	1.14	2.6	°C/W
R _{thJA}	Thermal resistance junction-ambient	50		°C/W

2 Electrical characteristics

$T_J = 25\text{ °C}$ unless otherwise specified

Table 4: Static characteristics

Symbol	Parameter	Test conditions	Min.	Typ.	Max.	Unit
$V_{(BR)CES}$	Collector-emitter breakdown voltage	$V_{GE} = 0\text{ V}$, $I_C = 2\text{ mA}$	600			V
$V_{CE(sat)}$	Collector-emitter saturation voltage	$V_{GE} = 15\text{ V}$, $I_C = 40\text{ A}$		1.8	2.3	V
		$V_{GE} = 15\text{ V}$, $I_C = 40\text{ A}$, $T_J = 125\text{ °C}$		2.15		
		$V_{GE} = 15\text{ V}$, $I_C = 40\text{ A}$, $T_J = 175\text{ °C}$		2.35		
V_F	Forward on-voltage	$I_F = 40\text{ A}$		1.7	2.45	V
		$I_F = 40\text{ A}$, $T_J = 125\text{ °C}$		1.4		
		$I_F = 40\text{ A}$, $T_J = 175\text{ °C}$		1.3		
$V_{GE(th)}$	Gate threshold voltage	$V_{CE} = V_{GE}$, $I_C = 1\text{ mA}$	5	6	7	V
I_{CES}	Collector cut-off current	$V_{GE} = 0\text{ V}$, $V_{CE} = 0\text{ V}$			25	μA
I_{GES}	Gate-emitter leakage current	$V_{CE} = 0\text{ V}$, $V_{GE} = \pm 20\text{ V}$			± 250	nA

Table 5: Dynamic characteristics

Symbol	Parameter	Test conditions	Min.	Typ.	Max.	Unit
C_{ies}	Input capacitance	$V_{CE} = 25\text{ V}$, $f = 1\text{ MHz}$, $V_{GE} = 0\text{ V}$	-	5400	-	pF
C_{oes}	Output capacitance		-	220	-	pF
C_{res}	Reverse transfer capacitance		-	180	-	pF
Q_g	Total gate charge	$V_{CC} = 480\text{ V}$, $I_C = 40\text{ A}$, $V_{GE} = 0\text{ to }15\text{ V}$ (see Figure 35: "Gate charge test circuit")	-	226	-	nC
Q_{ge}	Gate-emitter charge		-	38	-	nC
Q_{gc}	Gate-collector charge		-	95	-	nC

Table 6: IGBT switching characteristics (inductive load)

Symbol	Parameter	Test conditions	Min.	Typ.	Max.	Unit
$t_{d(on)}$	Turn-on delay time	$V_{CE} = 400\text{ V}$, $I_C = 40\text{ A}$, $R_G = 10\ \Omega$, $V_{GE} = 15\text{ V}$ (see Figure 34: "Test circuit for inductive load switching")	-	52	-	ns
t_r	Current rise time		-	17	-	ns
$(di/dt)_{on}$	Turn-on current slope		-	1850	-	A/ μ s
$t_{d(off)}$	Turn-off delay time		-	208	-	ns
t_f	Current fall time		-	20	-	ns
$E_{on}^{(1)}$	Turn-on switching energy		-	456	-	μ J
$E_{off}^{(2)}$	Turn-off switching energy		-	411	-	μ J
E_{ts}	Total switching energy		-	867	-	μ J
$t_{d(on)}$	Turn-on delay time	$V_{CE} = 400\text{ V}$, $I_C = 40\text{ A}$, $R_G = 10\ \Omega$, $V_{GE} = 15\text{ V}$, $T_J = 175\text{ }^\circ\text{C}$ (see Figure 34: "Test circuit for inductive load switching")	-	52	-	ns
t_r	Current rise time		-	21	-	ns
$(di/dt)_{on}$	Turn-on current slope		-	1538	-	A/ μ s
$t_{d(off)}$	Turn-off-delay time		-	220	-	ns
t_f	Current fall time		-	21	-	ns
$E_{on}^{(1)}$	Turn-on switching energy		-	1330	-	μ J
$E_{off}^{(2)}$	Turn-off switching energy		-	560	-	μ J
E_{ts}	Total switching energy		-	1890	-	μ J

Notes:

(1)Including the reverse recovery of the diode.

(2)Including the tail of the collector current.

Table 7: Diode switching characteristics (inductive load)

Symbol	Parameter	Test conditions	Min.	Typ.	Max.	Unit
t_{rr}	Reverse recovery time	$I_F = 40\text{ A}$, $V_R = 400\text{ V}$, $V_{GE} = 15\text{ V}$, $di/dt = 1000\text{ A}/\mu\text{s}$ (see Figure 34: "Test circuit for inductive load switching")	-	41	-	ns
Q_{rr}	Reverse recovery charge		-	440	-	nC
I_{rrm}	Reverse recovery current		-	21.6	-	A
dl_{rr}/dt	Peak rate of fall of reverse recovery current during t_b		-	1363	-	A/ μ s
E_{rr}	Reverse recovery energy		-	151	-	μ J
t_{rr}	Reverse recovery time	$I_F = 40\text{ A}$, $V_R = 400\text{ V}$, $V_{GE} = 15\text{ V}$, $di/dt = 1000\text{ A}/\mu\text{s}$, $T_J = 175\text{ }^\circ\text{C}$ (see Figure 34: "Test circuit for inductive load switching")	-	109	-	ns
Q_{rr}	Reverse recovery charge		-	2400	-	nC
I_{rrm}	Reverse recovery current		-	44.4	-	A
dl_{rr}/dt	Peak rate of fall of reverse recovery current during t_b		-	670	-	A/ μ s
E_{rr}	Reverse recovery energy		-	718	-	μ J

2.1 Electrical characteristics curves

Figure 2: Power dissipation vs case temperature for TO-247 and TO-3P

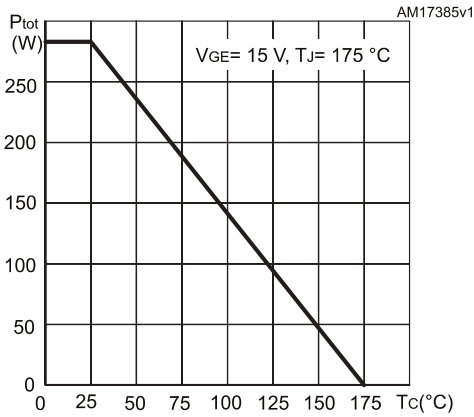

Figure 3: Collector current vs case temperature for TO-247 and TO-3P

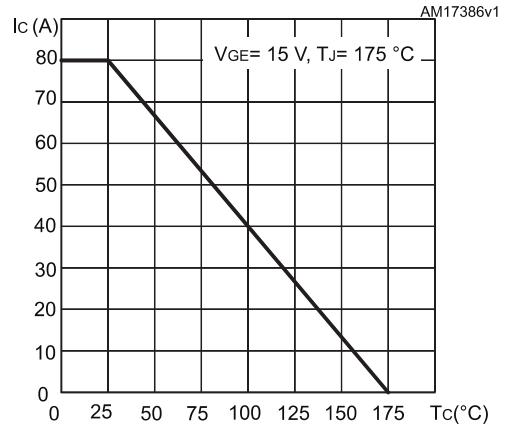

Figure 4: Power dissipation vs case temperature for TO-3PF

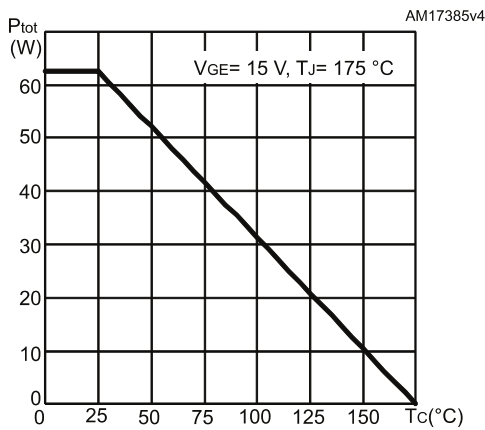

Figure 5: Collector current vs case temperature for TO-3PF

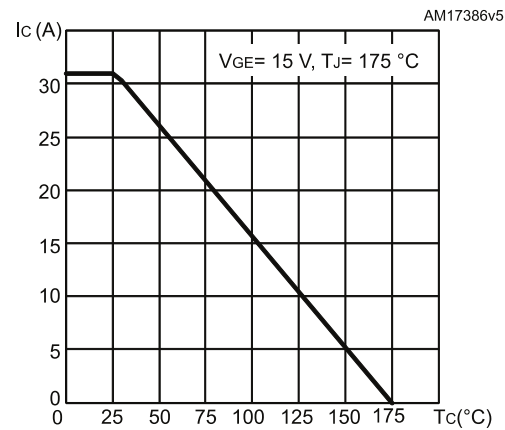

Figure 6: Output characteristics (T_J = 25 °C)

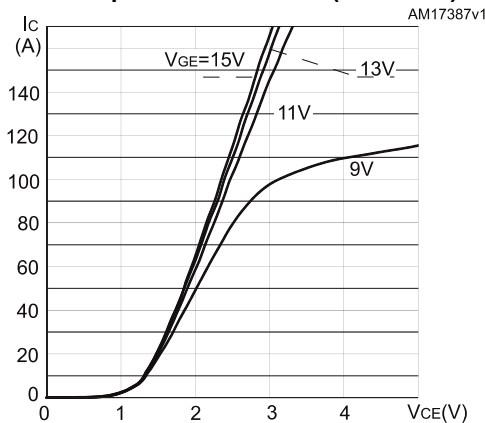
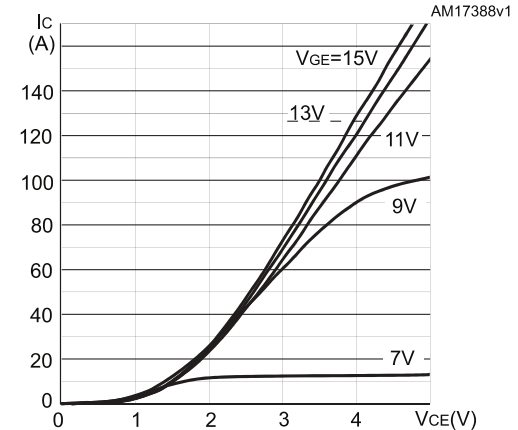
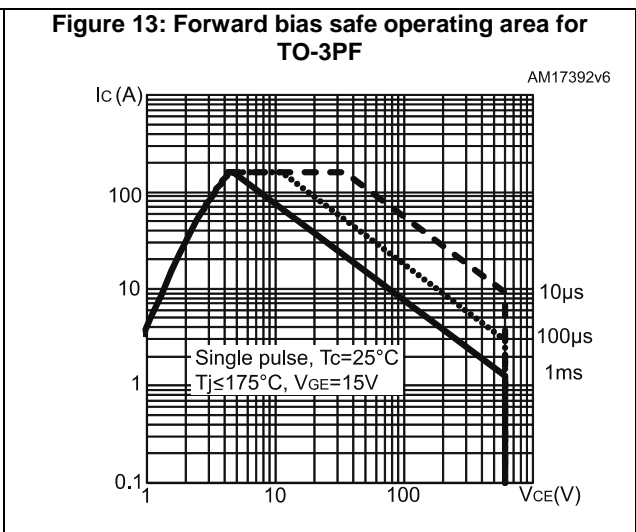
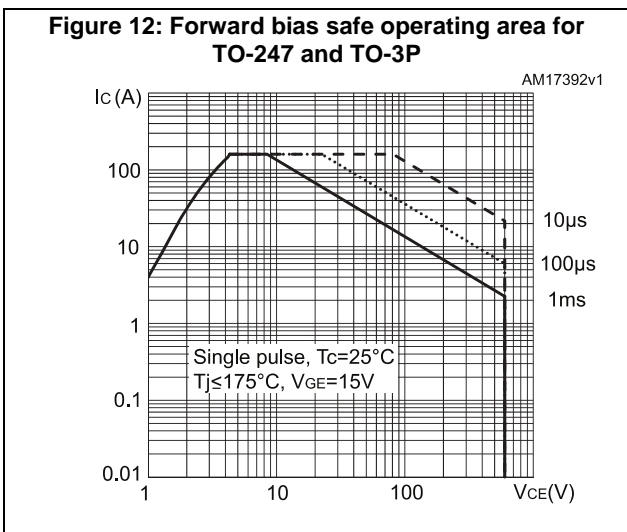
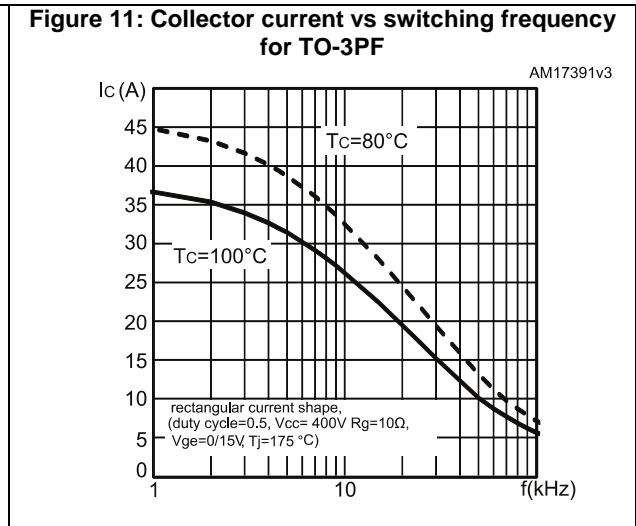
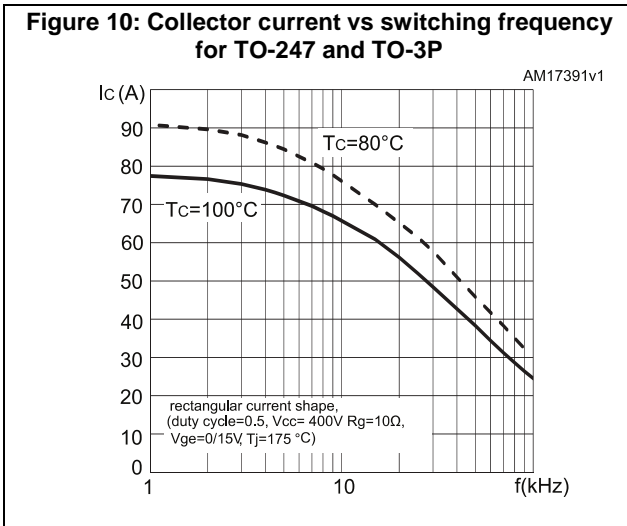
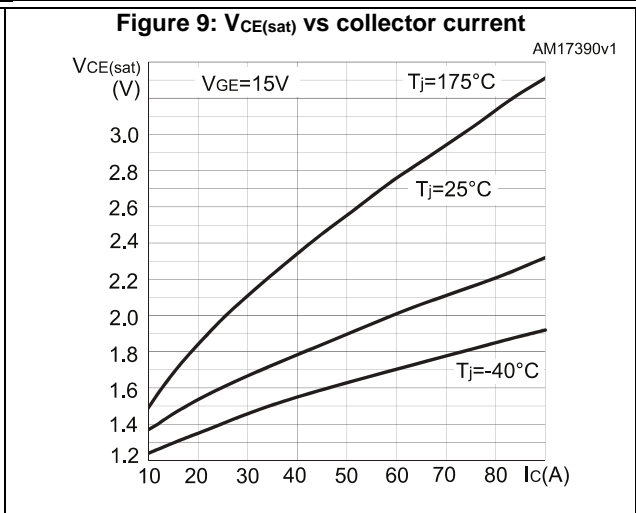
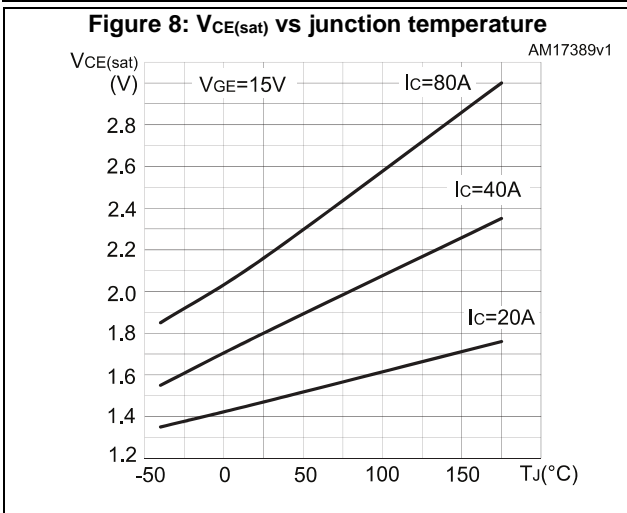
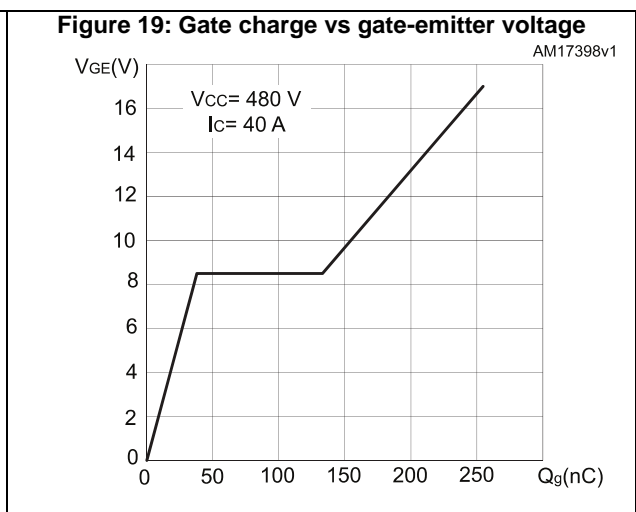
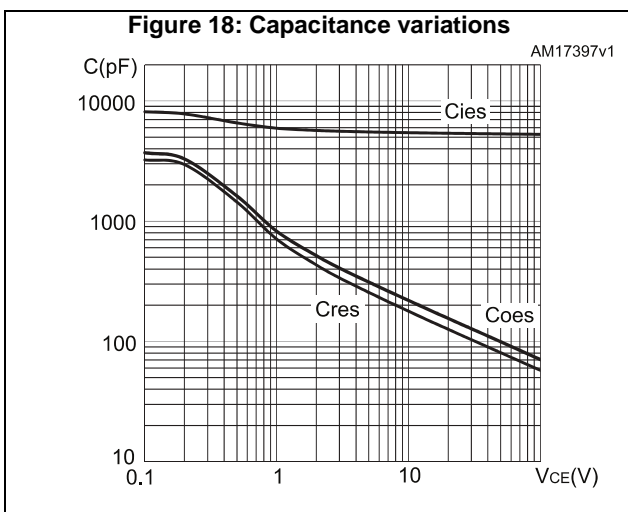
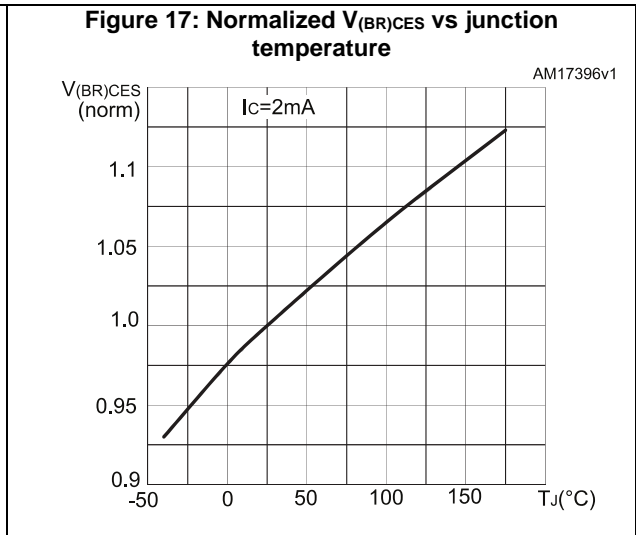
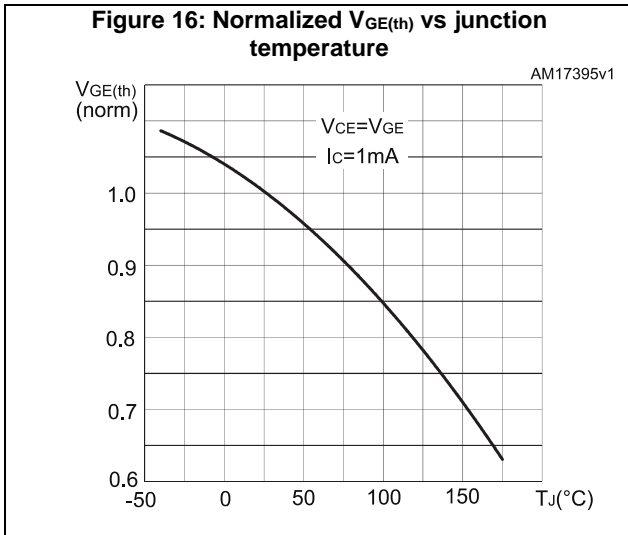
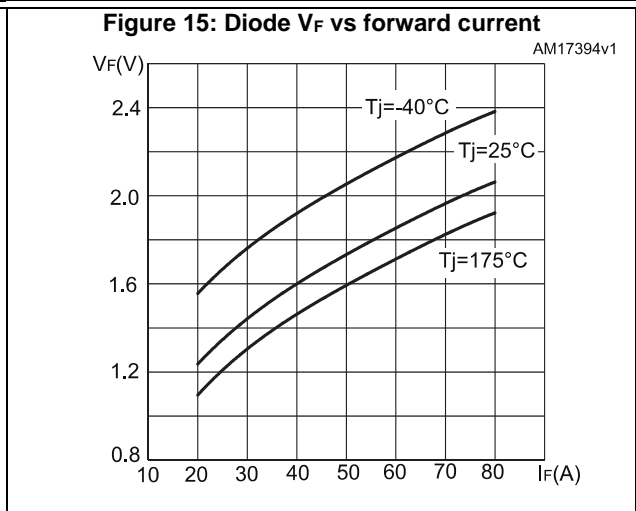
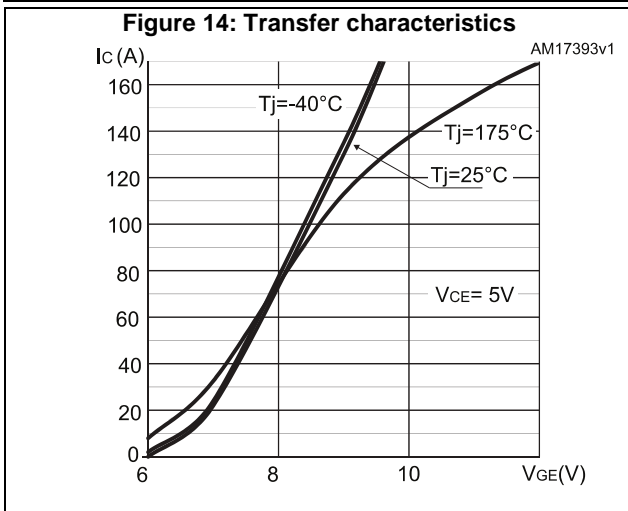

Figure 7: Output characteristics (T_J = 175 °C)







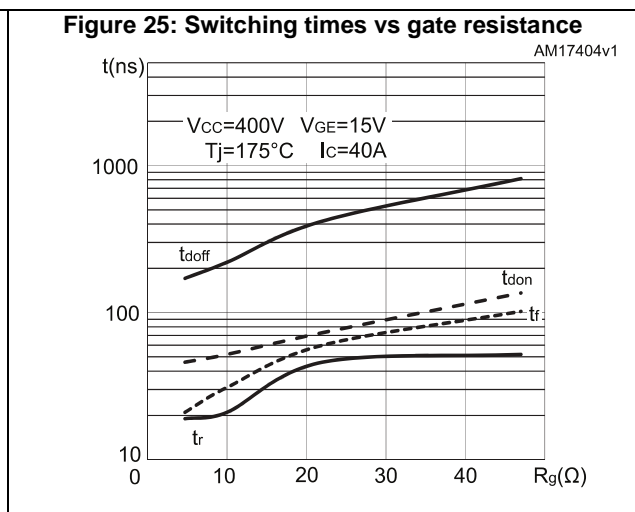
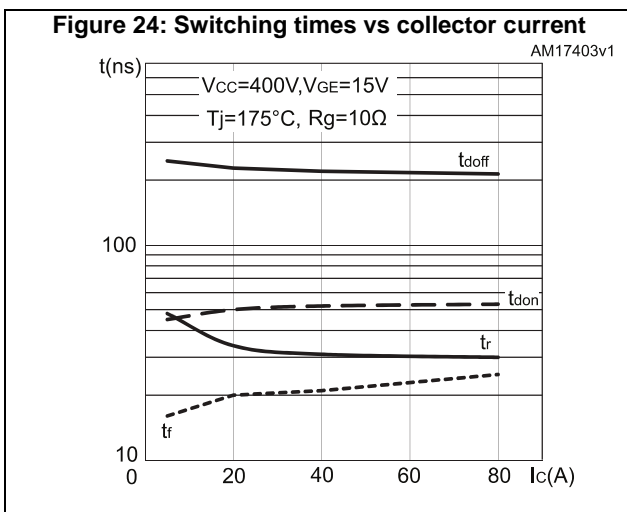
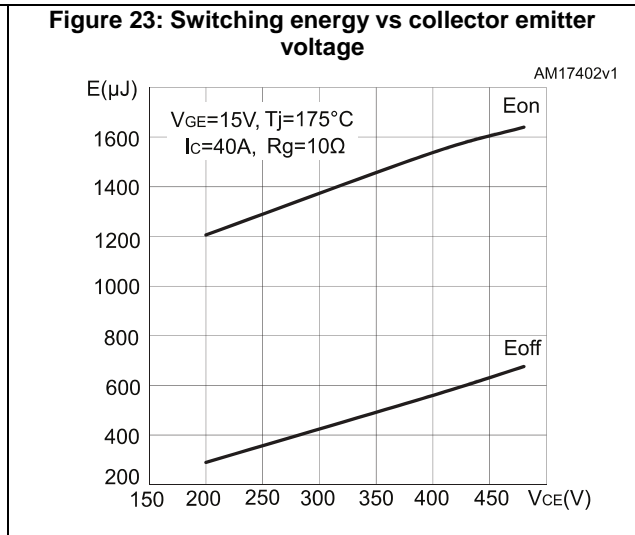
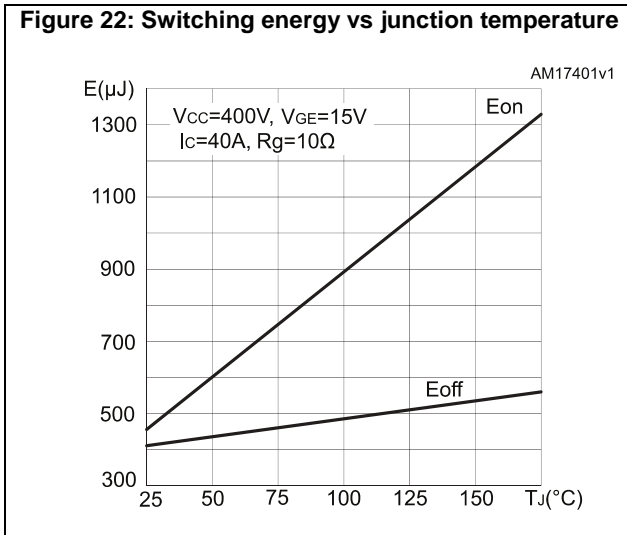
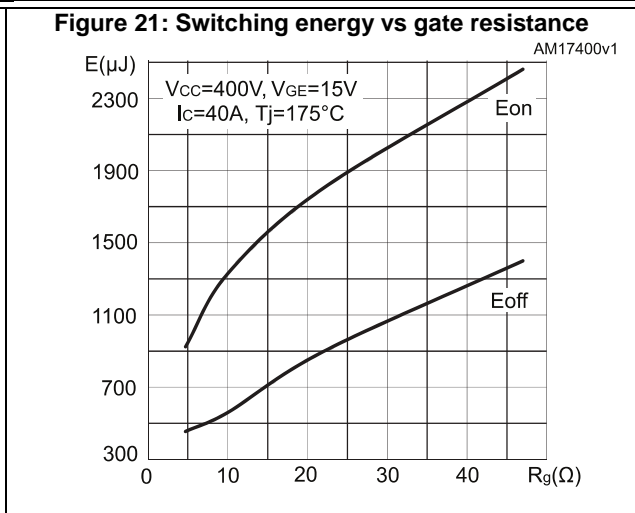
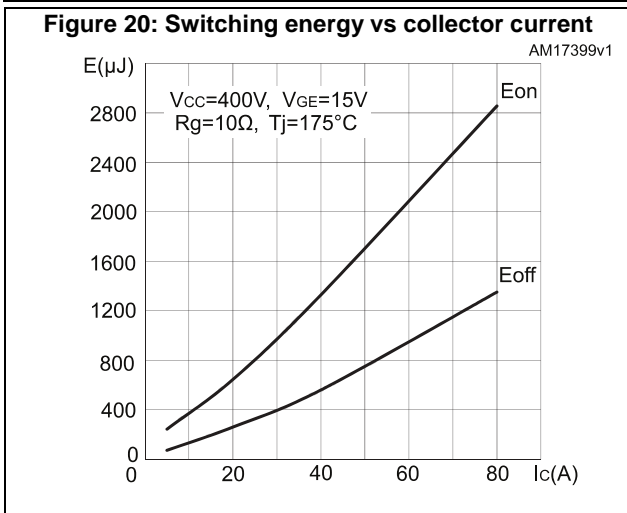

Figure 26: Reverse recovery current vs diode current slope

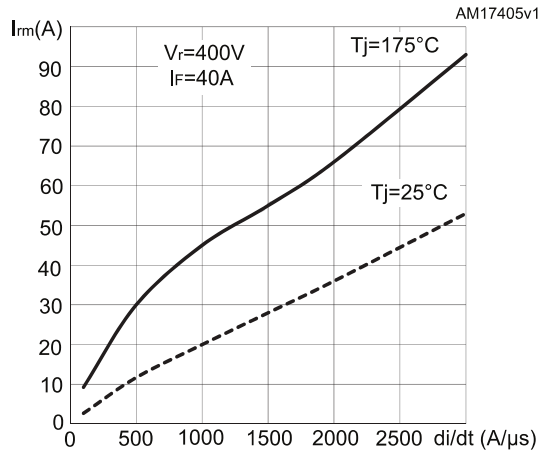

Figure 27: Reverse recovery time vs diode current slope

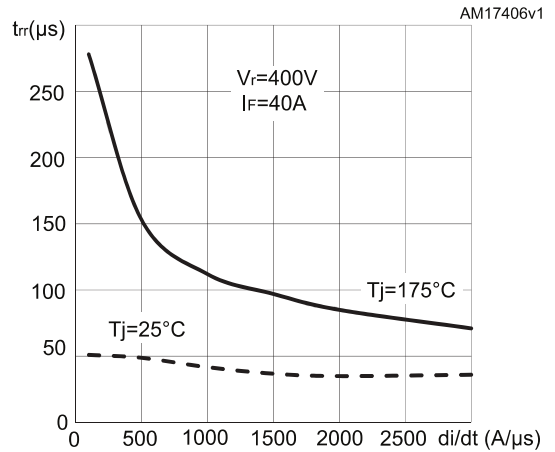

Figure 28: Reverse recovery charge vs diode current slope

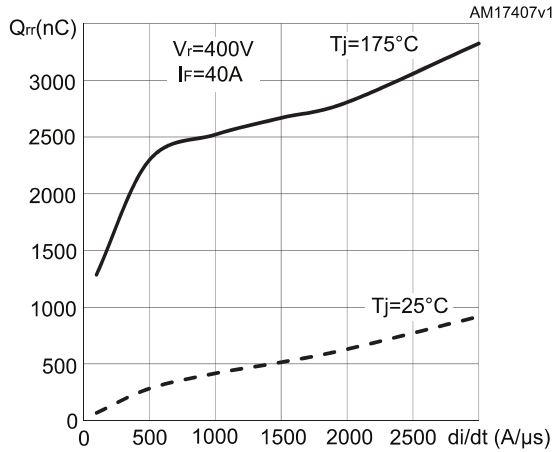

Figure 29: Reverse recovery energy vs diode current slope

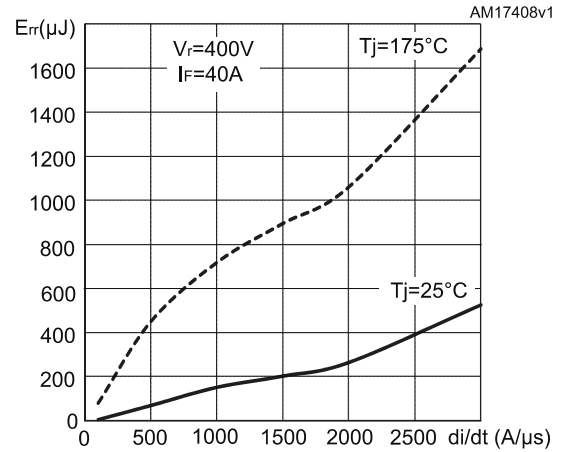

Figure 30: Thermal impedance for IGBT in TO-247 and TO-3P

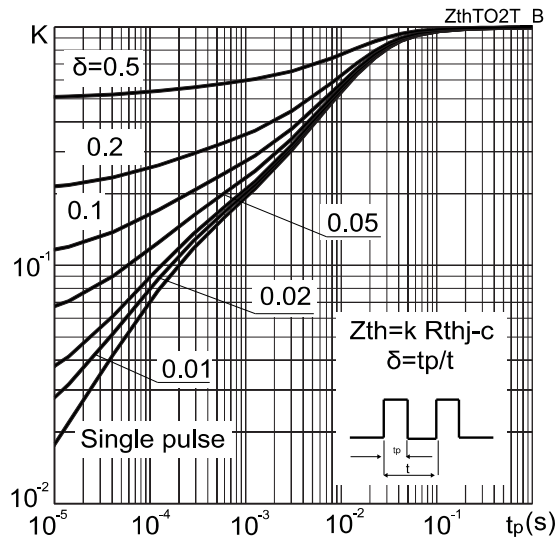

Figure 31: Thermal impedance for IGBT in TO-3PF

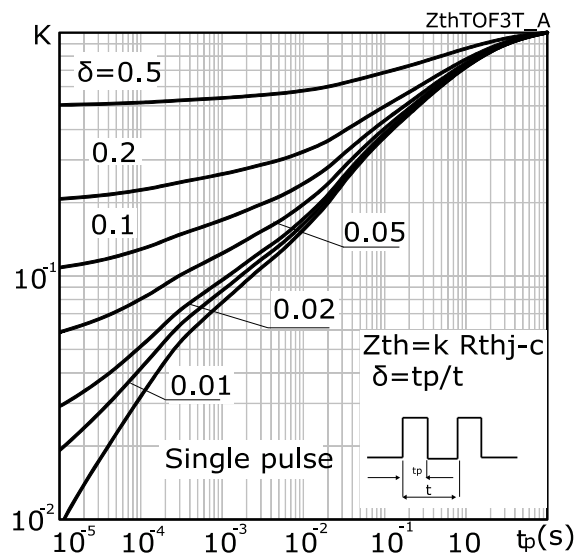

Figure 32: Thermal impedance for diode in TO-247 and TO-3P

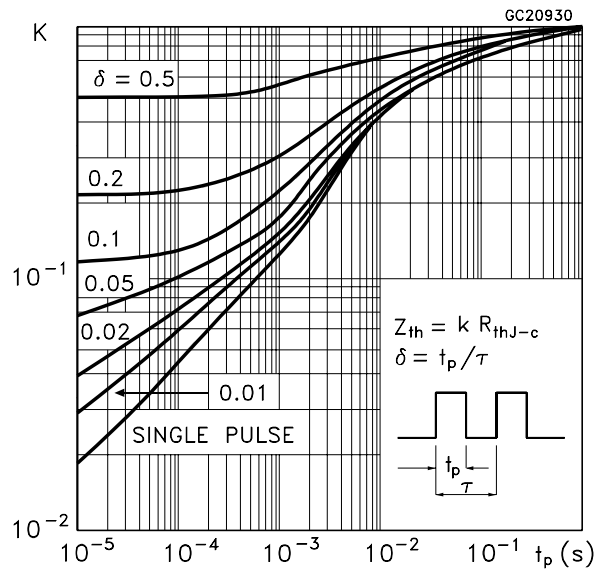
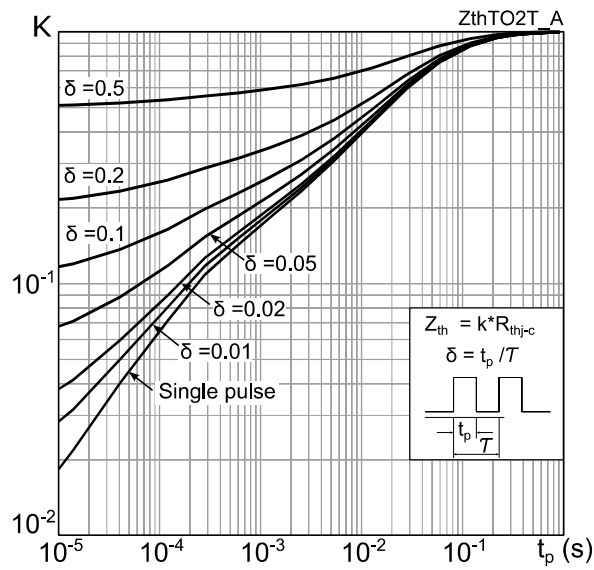
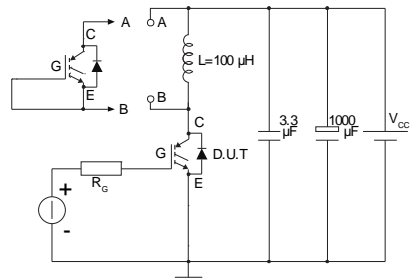

Figure 33: Thermal impedance for diode in TO-3PF



3 Test circuits

Figure 34: Test circuit for inductive load switching



AM01504v1

Figure 35: Gate charge test circuit

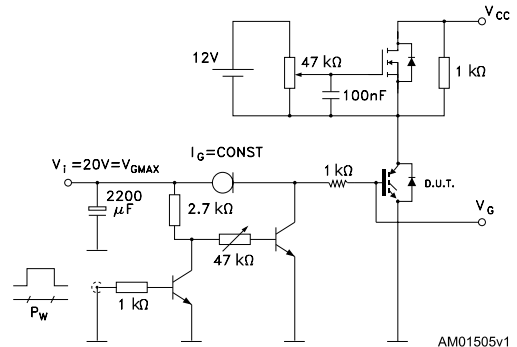

AM01505v1

Figure 36: Switching waveform

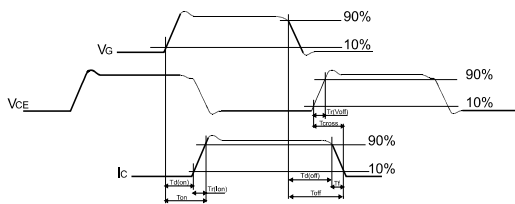

AM01506v1

Figure 37: Diode reverse recovery waveform

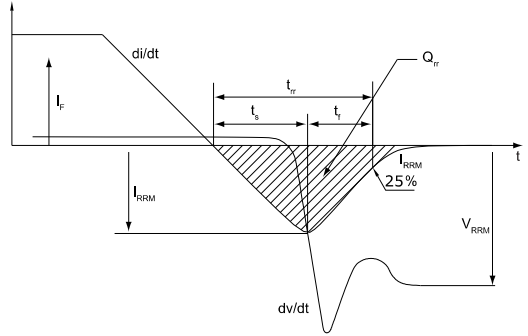

AM01507v1

4 Package information

In order to meet environmental requirements, ST offers these devices in different grades of ECOPACK® packages, depending on their level of environmental compliance. ECOPACK® specifications, grade definitions and product status are available at: www.st.com. ECOPACK® is an ST trademark.

4.1 TO-3PF package information

Figure 38: TO-3PF package outline

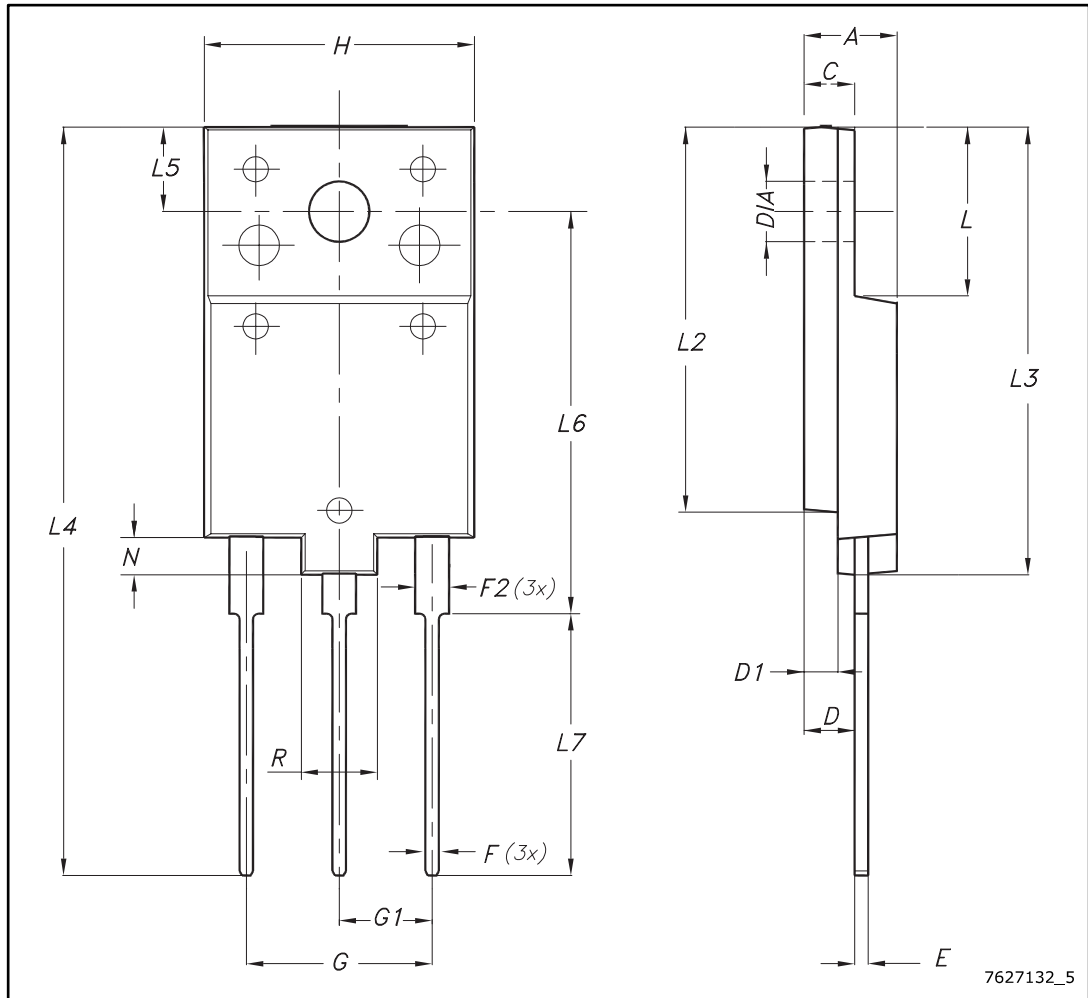

Table 8: TO-3PF mechanical data

Dim.	mm		
	Min.	Typ.	Max.
A	5.30		5.70
C	2.80		3.20
D	3.10		3.50
D1	1.80		2.20
E	0.80		1.10
F	0.65		0.95
F2	1.80		2.20
G	10.30		11.50
G1		5.45	
H	15.30		15.70
L	9.80	10	10.20
L2	22.80		23.20
L3	26.30		26.70
L4	43.20		44.40
L5	4.30		4.70
L6	24.30		24.70
L7	14.60		15
N	1.80		2.20
R	3.80		4.20
Dia	3.40		3.80

4.2 TO-247 package information

Figure 39: TO-247 package outline

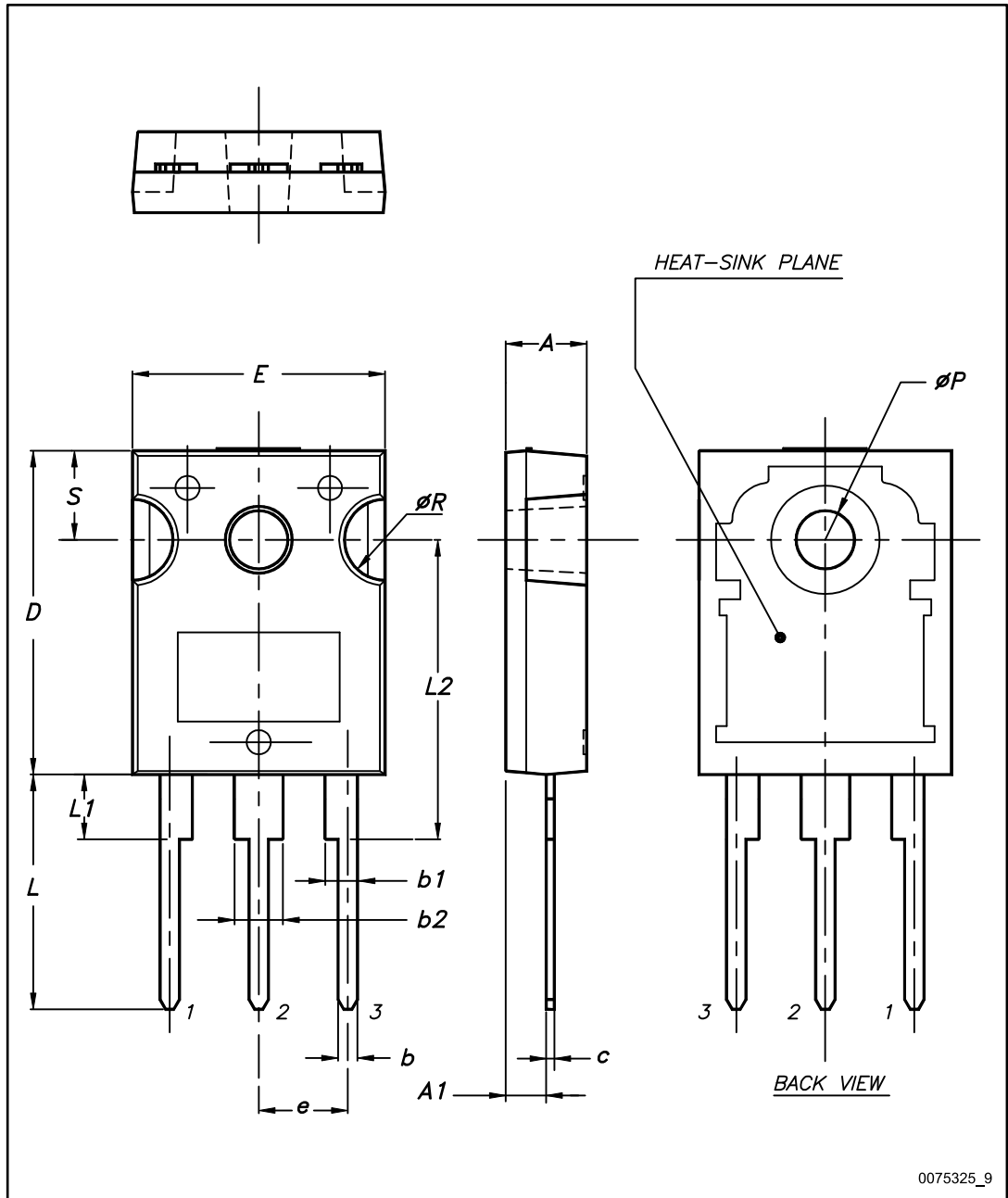

Table 9: TO-247 package mechanical data

Dim.	mm		
	Min.	Typ.	Max.
A	4.85		5.15
A1	2.20		2.60
b	1.0		1.40
b1	2.0		2.40
b2	3.0		3.40
c	0.40		0.80
D	19.85		20.15
E	15.45		15.75
e	5.30	5.45	5.60
L	14.20		14.80
L1	3.70		4.30
L2		18.50	
ØP	3.55		3.65
ØR	4.50		5.50
S	5.30	5.50	5.70

4.3 TO-3P package information

Figure 40: TO-3P package outline



Table 10: TO-3P package mechanical data

Dim.	mm		
	Min.	Typ.	Max.
A	4.60	4.80	5.00
A1	1.45	1.50	1.65
A2	1.20	1.40	1.60
b	0.80	1.00	1.20
b1	1.80	2.00	2.20
b2	2.80	3.00	3.20
c	0.55	0.60	0.75
D	19.70	19.90	20.10
D1	13.70	13.90	14.10
E	15.40	15.60	15.80
E1	13.40	13.60	13.80
E2	9.40	9.60	9.90
e	5.15	5.45	5.75
L	19.80	20.00	20.20
L1	3.30	3.50	3.70
L2	18.20	18.40	18.60
ØP	3.30	3.40	3.50
ØP1	3.10	3.20	3.30
Q	4.80	5.00	5.20
Q1	3.60	3.80	4

5 Revision history

Table 11: Document revision history

Date	Revision	Changes
20-Mar-2013	1	Initial release
17-Apr-2013	2	Document status promoted from preliminary data to production data. Added: <i>Section 2.1: Electrical characteristics (curves)</i>
04-Jun-2013	3	Added minimum and maximum values for $V_{GE(th)}$ in <i>Table 4: Static characteristics</i> .
11-Sep-2013	4	Updated V_F value in <i>Table 4: Static characteristics</i> .
08-Oct-2013	5	Updated title, features and description in cover page.
10-Jan-2014	6	Updated <i>Figure 8: $V_{CE(sat)}$ vs. junction temperature</i> , <i>Figure 15: Diode V_F vs. forward current</i> and <i>Figure 16: Normalized $V_{GE(th)}$ vs junction temperature</i> .
03-Mar-2014	7	Updated test conditions in <i>Table 7: Diode switching characteristics (inductive load)</i> .
23-Apr-2014	8	Added new device in TO-3PF. Updated <i>Table 1: Device summary</i> , <i>Table 2: Absolute maximum ratings</i> , <i>Table 3: Thermal data</i> and <i>Section 4: Package mechanical data</i> . Added <i>Figure 4: Power dissipation vs. case temperature for TO-3PF</i> , <i>Figure 5: Collector current vs. case temperature for TO-3PF</i> , <i>Figure 11: Collector current vs. switching frequency for TO-3PF</i> and <i>Figure 12: Forward bias safe operating area for TO-247 and TO-3P</i> . Minor text changes.
27-Oct-2017	9	Updated <i>Table 3: "Thermal data"</i> . Added <i>Figure 33: "Thermal impedance for diode in TO-3PF"</i> . Updated <i>Section 4: "Package information"</i> . Minor text changes

IMPORTANT NOTICE – PLEASE READ CAREFULLY

STMicroelectronics NV and its subsidiaries (“ST”) reserve the right to make changes, corrections, enhancements, modifications, and improvements to ST products and/or to this document at any time without notice. Purchasers should obtain the latest relevant information on ST products before placing orders. ST products are sold pursuant to ST’s terms and conditions of sale in place at the time of order acknowledgement.

Purchasers are solely responsible for the choice, selection, and use of ST products and ST assumes no liability for application assistance or the design of Purchasers’ products.

No license, express or implied, to any intellectual property right is granted by ST herein.

Resale of ST products with provisions different from the information set forth herein shall void any warranty granted by ST for such product.

ST and the ST logo are trademarks of ST. All other product or service names are the property of their respective owners.

Information in this document supersedes and replaces information previously supplied in any prior versions of this document.

© 2017 STMicroelectronics – All rights reserved