

3-phase Line Reactor for Motor Drive & Power Quality Applications

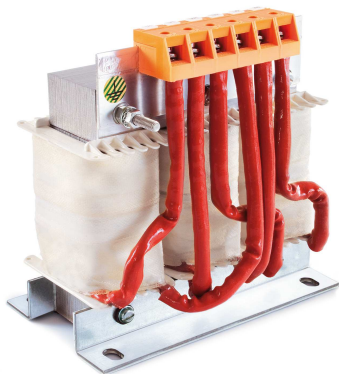

- Provision of 4% impedance
- Reduction of mains harmonics
- Reduction of commutation notches
- Protection of motor drive electronics
- Limitation of inrush currents
- Improvement of true power factor



Performance indicators

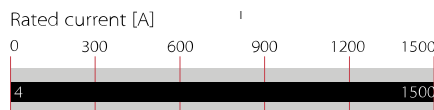

Approvals



UL 508C up to 400 A. For use with AC or DC drives (power conversion equipment) only

Features and benefits

- Ensure reliability, performance and a long service life of electrical consumers
- Reduction of mains harmonics and commutation notches
- Help to meet international power quality standards such as IEEE-519 or EN 61000-3-2
- Protection of motor drive electronics and dc link capacitors against mains transients
- Reduction of inrush and peak currents
- Reduction of conducted LF emission
- Improvement of conducted LF immunity
- Prevention from nuisance tripping caused by power line voltage spikes
- Improvement of true power factor

Technical specifications

Maximum continuous operating voltage	3 x 500/288 VAC
Design corresponding to	EN 61558-2-20 (VDE 0570-2-20), UL 508C, CSA C22.2 NO.14
Impedance	4% @ 400 VAC, 50 Hz & rated current
Typical harmonics reduction	See table on next page
High potential test voltage	P -> E 3000 VAC for 3 sec P -> P 3000 VAC for 3 sec
Insulation class	T40/N (200°C) for ≤400 A types T40/F (155°C) for ≥500 A types T40/H (180°C) for 1500 A types
Protection category	IP 00 (KL types according to VBG 4)
Rated currents	4 to 1500 A @ 40°C
Overload capability	2 x rated current at switch on for 30 seconds 1.5 x rated current for 1 minute, once per hour
Flammability corresponding to	UL 94 V-2 or better
Temperature range (operation and storage)	-25°C to +100°C (25/100/21)
MTBF @ 40°C/400 V (Mil-HB-217F)	>500,000 hours

Typical applications

- Motor drives and various adjustable speed drive systems, such as:
- Elevators
- Robots
- Machinery
- Process automation equipment

Typical electrical schematic

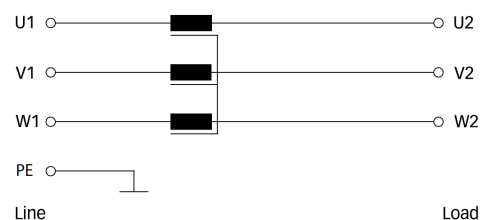

Reactor selection table

Reactor	Rated current @ 40°C [A]	Typical drive power rating* [kW]	Nominal inductance [mH]	Typical power loss** [W]	Input/Output connections		Weight Total [kg]	Earthing bolt
RWK 212-4-KL	4	1.5	7.3	23	KL		2.1	AMP 6,3 x 0,8
RWK 212-7-KL	7	3	4.2	36	KL		2.5	M4
RWK 212-11-KL	11	4	2.6	37	KL		2.5	M4
RWK 212-16-KL	16	7.5	1.8	59	KL		3.9	M5
RWK 212-21-KL	21	11	1.4	66	KL		5.4	M5
RWK 212-29-KL	29	15	1	69	KL		5.4	M5
RWK 212-35-KL	35	18.5	0.84	70	KL		5.9	M5
RWK 212-46-KL	46	22	0.64	99	KL		11	M6
RWK 212-60-KL	60	30	0.49	138	KL		15	M6
RWK 212-75-KL	75	37	0.39	133	KL		15	M6
RWK 212-95-KL	95	45	0.3	166	KL		22	M8
RWK 212-124-KS	124	55	0.23	172		KS	25	M8
RWK 212-156-KS	156	75	0.19	249		KS	25	M8
RWK 212-182-KS	182	90	0.16	245		KS	32	M10
RWK 212-230-KS	230	110/132	0.13	301		KS	35	M10
RWK 212-280-KS	280	160	0.1	335		KS	41	M10
RWK 212-330-KS	330	160	0.09	386		KS	56	M10
RWK 212-400-S	400	200	0.073	692		S	57	M10
RWK 212-500-S	500	250	0.058	761		S	67	M10
RWK 212-600-S	600	315	0.049	825		S	76	M10
RWK 212-680-S	680	355	0.043	876		S	80	M10
RWK 212-790-S	790	400	0.037	956		S	90	M10
RWK 212-910-S	910	450	0.032	1022		S	107	M10
RWK 212-1100-S	1100	630	0.026	1036		S	135	M10
RWK 212-1310-S	1310	725	0.023	1050		S	100	M10
RWK 212-1500-S	1500	830	0.020	1000		S	225	M10

Customized line reactors with different electrical and mechanical specifications are available on request.

* Calculated at rated current, 400 VAC and $\cos \phi=0.8$. The exact value depends upon the efficiency of the drive, the motor and the entire application.

** Power loss at 25°C/50 Hz, considering a typical harmonic spectrum of a motor drive with B6U rectifier bridge.

Harmonics reduction

Line reactors are a cost-effective way for the limitation of mains harmonics. The harmonics reduction capability is related to the reactor impedance. A higher impedance translates directly into lower harmonic currents, but of course also into a larger component with a higher voltage drop – and vice versa.

4% impedance reactors like RWK 212 provide an excellent cost/benefit ratio and are particularly beneficiary in the most diverse motor drive applications.

The table below shows various reactor impedance values and their calculated effect in terms of harmonics reduction.

Harmonic number/Input impedance (uk) vs. remaining harmonics [%]

	0.5%	1%	2%	3%	4%	5%	6%	7%	8%	9%	10%
5th	80	60	46	40	34	32	30	28	26	24	23
7th	60	37	22	16	13	12	11	10	9	8.3	7.5
11th	18	12	9	7.3	6.3	5.8	5.2	5	4.3	4.2	4
13th	10	7.5	5.8	4.9	4.2	3.9	3.6	3.3	3.15	3	2.8
17th	7.3	5.2	3.6	3	2.4	2.2	2.1	0.9	0.7	0.5	0.4
19th	6	4.2	2.8	2.2	2	0.8	0.7	0.4	0.3	0.25	0.2
%THID	102.5	72.2	52.3	44.13	37.31	34.96	32.65	30.35	28.04	25.92	24.68

Reading example: a 4% impedance reactor typically reduces the THID to ~37% of the fundamental.

Mechanical data

4 to 46 A types

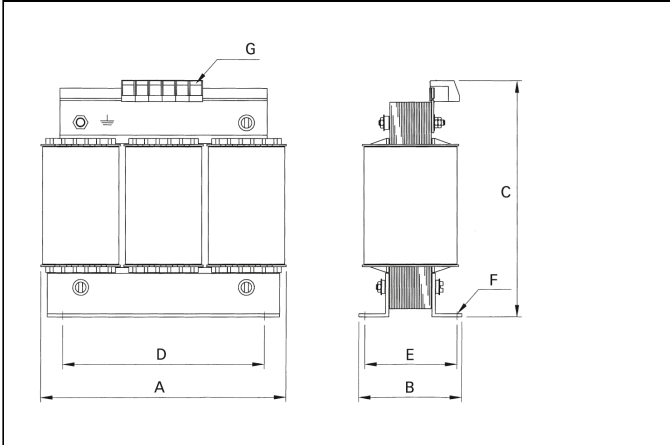

60 to 95 A types

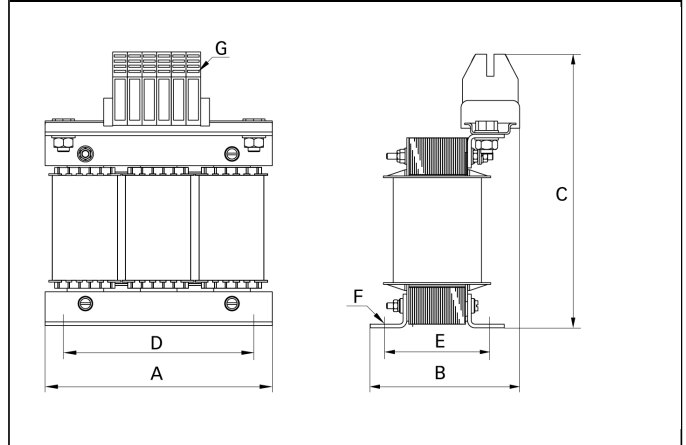

124 to 330 A types

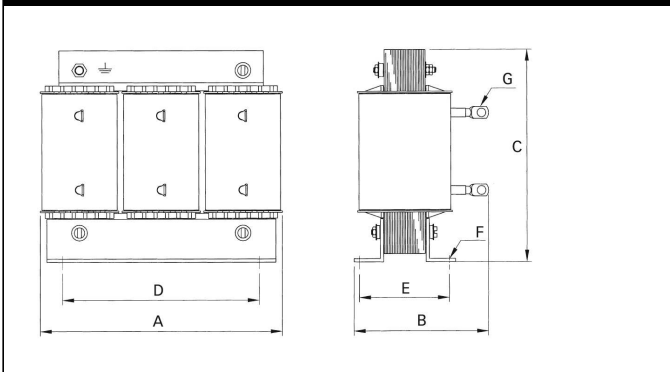

400 to 1500 A types

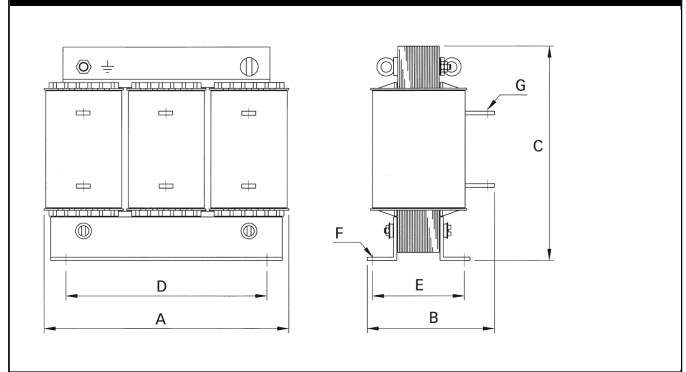

Dimensions

	A	B	C	D	E	F	G
4 A	100	max. 70	max. 115	56	43	4.8 x 9	2.5 mm ²
7 and 11 A	125	max. 80	max. 130	100	55	5 x 8	2.5 mm ²
16 A	155	max. 80	max. 155	130	56.5	8 x 12	4 mm ²
21 A	155	max. 95	max. 155	130	70.5	8 x 12	4 mm ²
29 A	155	max. 95	max. 155	130	71.5	8 x 12	4 mm ²
35 A	155	max. 105	max. 170	130	70	8 x 12	10 mm ²
46 A	190	max. 120	max. 195	170	77.5	8 x 12	10 mm ²
60 A	210	max. 155	max. 240	175	97	8 x 12	16 mm ²
75 A	210	max. 160	max. 249	175	97	8 x 12	35 mm ²
95 A	230	max. 185	max. 275	180	122	8 x 12	35 mm ²
124 and 156 A	240	max. 210	max. 210	190	129	11 x 15	Ø10
182 A	265	max. 210	max. 230	215	114	11 x 15	Ø10
230 A	300	210	270	240	131	11 x 15	Ø12
280 A	300	218	270	240	139	11 x 15	Ø12
330 A	300	255	270	240	166	11 x 15	Ø12
400 A	420	205	390	370	133	11 x 15	Ø11
500 A	420	215	390	370	140	11 x 15	Ø14
600 A	420	225	390	370	149	11 x 15	Ø14
680 A	420	225	390	370	150	11 x 15	Ø14
790 A	420	240	390	370	162	11 x 15	Ø18
910 A	420	255	390	370	177	11 x 15	2 x Ø11
1100 A	420	290	390	370	200	11 x 15	2 x Ø11
1310 A	420	255	490	370	172	11 x 15	2 x Ø14
1500 A	551	400	613	490	266	13 x 18	4 x Ø13

All dimensions in mm; 1 inch = 25.4 mm
Tolerances according: ISO 2768-m/EN 22768-m

Please visit www.schaffner.com to find more details on filter connectors.



Headquarters, global innovation and development

Switzerland

Schaffner Group

Nordstrasse 11
4542 Luterbach
T +41 32 681 66 26
info@schaffner.com
www.schaffner.com



Sales and application centers

China

Schaffner EMC Ltd. Shanghai

T20-3 C, No 565 Chuangye Road,
Pudong district
201201 Shanghai
T +86 21 3813 9500
cschina@schaffner.com
www.schaffner.com.cn

Finland

Schaffner Oy

Sauvonrinne 19 H
08500 Lohja
T +358 50 468 7284
finlandsales@schaffner.com

France

Schaffner EMC S.A.S.

16-20 Rue Louis Rameau
95875 Bezons
T +33 1 34 34 30 60
F +33 1 39 47 02 28
francesales@schaffner.com

Germany

Schaffner Deutschland GmbH

Schoemperlenstrasse 12B
76185 Karlsruhe
T +49 721 56910
F +49 721 569110
germanysales@schaffner.com

India

Schaffner India Pvt. Ltd

REGUS WORLD TRADE CENTRE
WTC, 22nd Floor Unit No 2238, Brigade
Gateway Campus, 26/1, Dr. Rajkumar Road
Malleswaram (W)
560055 Bangalore
T +91 80 67935355
indiasales@schaffner.com

Italy

Schaffner EMC S.r.l.

Via Ticino, 30
20900 Monza (MB)
T +39 039 21 41 070
italysales@schaffner.com

Japan

Schaffner EMC K.K.

1-32-12, Kamiyama, Setagaya-ku
7F Mitsui-seimei Sangenjaya Bldg.
154-0011 Tokyo
T +81 3 5712 3650
F +81 3 5712 3651
japansales@schaffner.com
www.schaffner.jp

Singapore

Schaffner EMC Pte Ltd.

#05-09, Kg Ubi Ind. Estate
408705 Singapore
T +65 6377 3283
F +65 6377 3281
singaporesales@schaffner.com

Spain

Schaffner EMC España

Calle Caléndula 93, Miniparc III, Edificio E
El Soto de Moraleja, Alcobendas
28109 Madrid
T +34 917 912 900
F +34 917 912 901
spainsales@schaffner.com

Sweden

Schaffner EMC AB

Tegeluddsvägen 76, 2tr
115 28 Stockholm
T +46 8 5050 2425
swedensales@schaffner.com
www.schaffner.com

Switzerland

Schaffner EMV AG

Nordstrasse 11
4542 Luterbach
T +41 32 681 66 26
switzerlandsales@schaffner.com

Taiwan R.O.C.

Schaffner EMV Ltd.

20 Floor-2, No 97, Section 1, XinTai 5th Road
22175 XiZhi District New Taipei City 22175
T +886 2 2697 5500
F +886 2 2697 5533
taiwansales@schaffner.com
www.schaffner.com.tw

Thailand

Schaffner EMC Co. Ltd.

Northern Region Industrial Estate
67 Moo 4 Tambon Ban Klang
Amphur Muangng P.O. Box 14
51000 Lamphun
T +66 53 58 11 04
F +66 53 58 10 19
thailandsales@schaffner.com

United Kingdom

Schaffner Ltd.

5 Ashville Way, Molly Millars Lane
Wokingham
RG41 2PL Berkshire
T +44 118 9770070
F +44 118 9792969
uksales@schaffner.com

USA

Schaffner EMC Inc.

52 Mayfield Avenue
08837 Edison, New Jersey
T +1 800 367 5566
T +1 732 225 9533
F +1 732 225 4789
usasales@schaffner.com
www.schaffnerusa.com

Schaffner North America

6722 Thirlane Road
24019 Roanoke, Virginia
T +1 276 228 7943
F +1 276 228 7953

Schaffner North America

823 Fairview Road
24382 Wytheville, Virginia
T +1 276 228 7943
F +1 276 228 7258

To find your local partner within Schaffner's global network: www.schaffner.com

© 2018 Schaffner Group

The content of this document has been carefully checked and understood. However, neither Schaffner nor its subsidiaries assume any liability whatsoever for any errors or inaccuracies of this document and the consequences thereof. Published specifications are subject to change without notice. Product suitability for any area of application must ultimately be determined by the customer. In all cases, products must never be operated outside their published specifications. Schaffner does not guarantee the availability of all published products. This disclaimer shall be governed by substantive Swiss law and resulting disputes shall be settled by the courts at the place of business of Schaffner Holding AG. Latest publications and a complete disclaimer can be downloaded from the Schaffner website. All trademarks recognized.