



Main

| | |
|---------------------------|--|
| Range of product | OsiSense XM |
| Product or component type | Electronic pressure sensors |
| Pressure sensor type | Pressure transmitter |
| Pressure sensor name | XMLK |
| Electrical circuit type | Control circuit |
| Pressure sensor size | 87.02 psi (6 bar) |
| Local display | Without |
| Controlled fluid | Air 32...176 °F (0...80 °C) Fresh water 32...176 °F (0...80 °C) |
| Fluid connection type | G 1/4A (male) conforming to DIN 3852-E |
| Electrical connection | 1 male connector M12 4 pins |
| [Us] rated supply voltage | 24 V DC SELV, voltage limits: 16.2...33 V |
| Current consumption | < 6 mA |
| Type of output signal | Analogue |
| Analogue output function | 0...10 V, 3-wire |
| Quantity per set | Set of 1 |
| Type of packing | Individual |

Complementary

| | |
|---|---|
| Pressure setting range | 0...87.02 psi (0...6 bar) |
| Maximum permissible accidental pressure | 174.05 psi (12 bar) |
| Destruction pressure | 261.07 psi (18 bar) |
| Materials in contact with fluid | Ceramic Nitrile (NBR) Stainless steel type AISI 303 |
| Operating position | Any position |
| Protection type | Load short-circuit Reverse polarity |
| Electromagnetic compatibility | Electrostatic discharge immunity test conforming to EN/IEC 61000-4-2 - test level 8 kV air, 6 kV contact Susceptibility to electromagnetic fields conforming to EN/IEC 61000-4-3 - test level 10 V/m (f = 80...1000 MHz) Electrical fast transient/burst immunity test conforming to EN/IEC 61000-4-4 - test level 2 kV 1.2/50 µs shock waves immunity test conforming to EN/IEC 61000-4-5 - test level 500 V 12 Ohm, 1 kV 42 Ohm Radiated RF fields conforming to EN/IEC 61000-4-6 - test level 10 V (f = 0.15...80 MHz) Immunity to magnetic fields conforming to EN/IEC 61000-4-8 - test level 30 A/m (f = 50 Hz) |
| [Uimp] rated impulse withstand voltage | 0.5 kV |
| Response time on output | < 5 ms |
| Measurement accuracy | +/- 1 % of the measuring range |
| Accuracy | 0.1 % of the measuring range |
| Drift of the sensitivity | +/- 0.04 % of measuring range/°K |
| Drift of the zero point | +/- 0.03 % of measuring range/°K |
| Repeat accuracy | +/- 1 % of the measuring range |
| Mechanical durability | >= 10000000 cycles |
| Product weight | 0.24 lb(US) (0.11 kg) |
| Diameter | 1.42 in (36 mm) |
| Length | 2.66 in (67.5 mm) |
| Scale type | Fixed differential |

The information provided in this documentation contains general descriptions and/or technical characteristics of the products contained herein. This documentation is not intended as a substitute for and is not to be used for determining suitability or reliability of these products for specific user applications. It is the duty of any such user or integrator to perform the appropriate and complete risk analysis, evaluation and testing of the products with respect to the relevant specific application or use thereof. Neither Schneider Electric Industries SAS nor any of its affiliates or subsidiaries shall be responsible or liable for misuse of the information contained herein.

Environment

| | |
|---------------------------------------|--|
| standards | CE EN/IEC 61326-2-3 |
| product certifications | UL 508 RCM CSA C22.2 No 14 EAC |
| protective treatment | TC |
| ambient air temperature for operation | 32...176 °F (0...80 °C) |
| ambient air temperature for storage | -13...176 °F (-25...80 °C) |
| vibration resistance | 20 gn (f = 9...2000 Hz) conforming to EN/IEC 60068-2-6 |
| shock resistance | 25 gn 11 ms conforming to EN/IEC 60068-2-27 |
| IP degree of protection | IP65 conforming to EN/IEC 60529 |
| NEMA degree of protection | NEMA 4 |

Offer Sustainability

| | |
|--|--|
| Not Green Premium product | Not Green Premium product |
| Compliant - since 1001 - Schneider Electric declaration of conformity | Compliant - since 1001 - Schneider Electric declaration of conformity |
| Reference not containing SVHC above the threshold | Reference not containing SVHC above the threshold |
| WARNING: This product can expose you to chemicals including: | WARNING: This product can expose you to chemicals including: |
| Diisononyl phthalate (DINP), which is known to the State of California to cause cancer, and | Diisononyl phthalate (DINP), which is known to the State of California to cause cancer, and |
| Di-isodecyl phthalate (DIDP), which is known to the State of California to cause birth defects or other reproductive harm. | Di-isodecyl phthalate (DIDP), which is known to the State of California to cause birth defects or other reproductive harm. |
| For more information go to www.p65warnings.ca.gov | For more information go to www.p65warnings.ca.gov |

Contractual warranty

| | |
|-----------------|-----------|
| Warranty period | 18 months |
|-----------------|-----------|

Dimensions

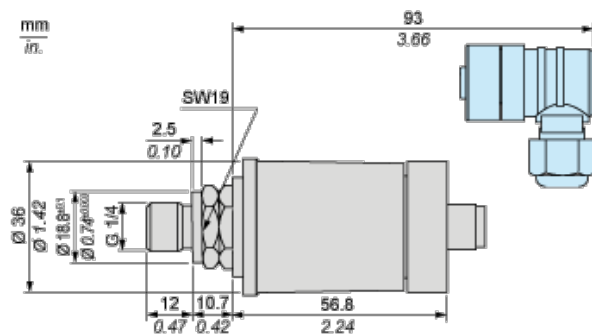

Wiring Diagram

3-Wire Technique (0-10 V)

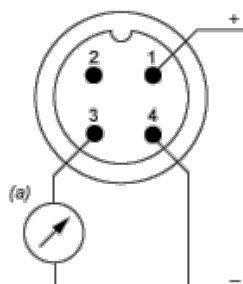

(a) V out

Output Curves

