

**600mA Synchronous DC-DC Step Down Regulator (2ch)  
300mA LDO Regulator (6ch)  
Multi Power Supply (High Efficiency Power LSI)**

**FEATURES**

- High-Speed Response DC-DC Step Down Regulator Circuit that employs Hysteretic System
- DC-DC Step Down Regulator : 2-ch  
Input voltage Range VBAT :2.5V to 5.5V  
DVDD : 1.7V to 3.0V  
Output voltage Range 0.8 V to 2.4 V  
Up to 600 mA Output Current
- LDO Regulator : 6-ch  
Input voltage Range VBAT :2.5V to 5.5V  
DVDD : 1.7V to 3.0V  
Output voltage Range 1.0 V to 3.3 V  
Up to 300 mA Output Current
- I<sup>2</sup>C control (2-slave address selectable)
- 25 pin Wafer Level Chip Size Package (WLCSP)  
(Size : 2.15 mm × 2.15 mm, 0.4 mm Pitch)

**DESCRIPTION**

AN30182A is a multi power supply LSI which has High-Speed Response DC-DC Step Down Regulators (2-ch) and LDO Regulators (6-ch).  
By this DC-DC system, when load current charges suddenly, it responds at high speed and minimizes the changes of output voltage.  
Since it is possible to use capacitors with small capacitance and it is unnecessary to add external parts for system phase compensation, this IC realizes downsizing of set and reducing in the number of external parts.  
The output DC of each power supply is variable by I<sup>2</sup>C control.

**APPLICATIONS**

Mobile phone, Portable appliance, etc

**SIMPLIFIED APPLICATION**

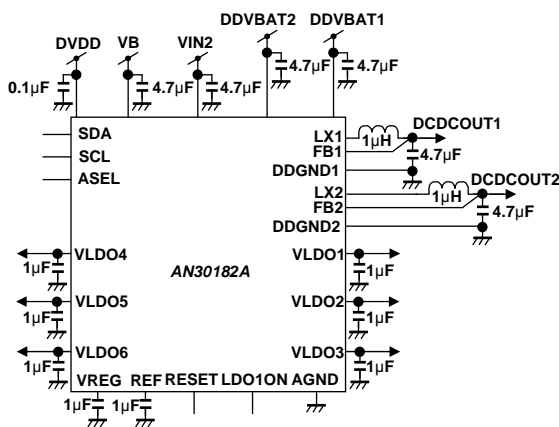

Notes) This application circuit is an example. The operation of mass production set is not guaranteed. You should perform enough evaluation and verification on the design of mass production set. You are fully responsible for the incorporation of the above application circuit and information in the design of your equipment.

**EFFICIENCY CURVE**

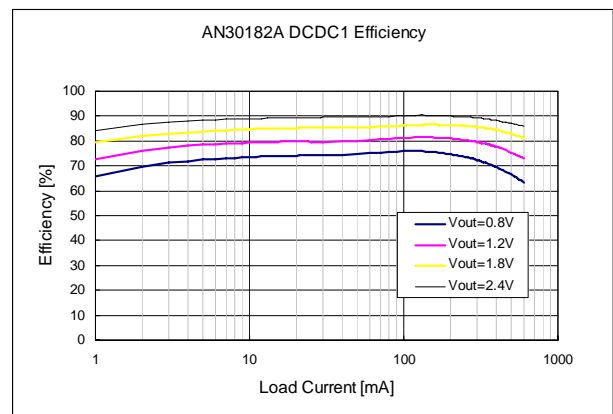

Condition )  
DDVBAT1 = DDVBAT2 = VB = VIN2 = 3.7V  
Lo = 1.0 µH, Cout = 4.7 µF  
Vout=0.8 , 1.2 , 1.8 , 2.4V

**ABSOLUTE MAXIMUM RATINGS**

Parameter	Symbol	Rating	Unit	Notes
Supply voltage	VB, VIN2, DDVBAT1, DDVBAT2	6.0	V	*1
	DVDD	3.6	V	*1
Operating free-air temperature	T <sub>opr</sub>	- 30 to + 85	°C	*2
Operating junction temperature	T <sub>j</sub>	- 30 to + 150	°C	*2
Storage temperature	T <sub>stg</sub>	- 55 to + 150	°C	*2
Input Voltage Range	RESET, LDO1ON, FB1, FB2	- 0.3 to V <sub>VBAT</sub> + 0.3	V	*1 *3
	SCL, SDA, ASEL	- 0.3 to V <sub>DVDD</sub> + 0.3	V	*1 *3
Output Voltage Range	LX1, LX2, VREG, REF, LDO1, LOD2, LDO3, LDO4, LDO5, LDO6	- 0.3 to V <sub>VBAT</sub> + 0.3	V	*1 *3
ESD	HBM (Human Body Model)	2	kV	—

Notes) Do not apply external currents and voltages to any pin not specifically mentioned.

This product may sustain permanent damage if subjected to conditions higher than the above stated absolute maximum rating.

This rating is the maximum rating and device operating at this range is not guaranteeable as it is higher than our stated recommended operating range. When subjected under the absolute maximum rating for a long time, the reliability of the product may be affected.

\*1: The values under the condition not exceeding the above absolute maximum ratings and the power dissipation.

\*2: Except for the power dissipation, operating ambient temperature, and storage temperature, all ratings are for Ta = 25 °C.

\*3: V<sub>VBAT</sub> is voltage for DDVBAT1, DDVBAT2. VB = VIN2, (V<sub>VBA</sub> + 0.3) V must not be exceeded 6 V.

V<sub>DVDD</sub> is voltage for DVDD, (V<sub>DVDD</sub> + 0.3) V must not be exceeded 3.6 V.

**POWER DISSIPATION RATING**

PACKAGE	θ <sub>JA</sub>	PD ( Ta = 25 °C )	PD ( Ta = 85 °C )	Notes
25 pin Wafer level chip size Package (WLCSP Type)	294.1 °C / W	0.425 W	0.221 W	*1

Note). For the actual usage, please refer to the PD-Ta characteristics diagram in the package specification, follow the power supply voltage, load and ambient temperature conditions to ensure that there is enough margin and the thermal design does not exceed the allowable value.

\*1: Glass Epoxy Substrate ( 4 Layers ) [ Glass-Epoxy: 50 X 50 X 0.8 t ( mm ) ]

Die Pad Exposed , Soldered.



**CAUTION**

Although this has limited built-in ESD protection circuit, but permanent damage may occur on it. Therefore, proper ESD precautions are recommended to avoid electrostatic damage to the MOS gates

RECOMMENDED OPERATING CONDITIONS

Parameter	Pin Name	Min.	Typ.	Max.	Unit	Notes
Supply voltage range	VB	2.5	3.7	5.5	V	*1
	VIN2	2.5	3.7	5.5	V	*1
	DDVBAT1	2.5	3.7	5.5	V	*1
	DDVBAT2	2.5	3.7	5.5	V	*1
	DVDD	1.7	1.85	3.0	V	*1
Input Voltage Range	RESET	-0.3	—	$V_{VBAT} + 0.3$	V	*2
	LDO1ON	-0.3	—	$V_{VBAT} + 0.3$	V	*2
	FB1	-0.3	—	$V_{VBAT} + 0.3$	V	*2
	FB2	-0.3	—	$V_{VBAT} + 0.3$	V	*2
	SCL	-0.3	—	$V_{DVDD} + 0.3$	V	*2
	SDA	-0.3	—	$V_{DVDD} + 0.3$	V	*2
	ASEL	-0.3	—	$V_{DVDD} + 0.3$	V	*2
Output Voltage Range	LX1	-0.3	—	$V_{VBAT} + 0.3$	V	*2
	LX2	-0.3	—	$V_{VBAT} + 0.3$	V	*2
	VREG	-0.3	—	$V_{VBAT} + 0.3$	V	*2
	REF	-0.3	—	$V_{VBAT} + 0.3$	V	*2
	LDO1	-0.3	—	$V_{VBAT} + 0.3$	V	*2
	LDO2	-0.3	—	$V_{VBAT} + 0.3$	V	*2
	LDO3	-0.3	—	$V_{VBAT} + 0.3$	V	*2
	LDO4	-0.3	—	$V_{VBAT} + 0.3$	V	*2
	LDO5	-0.3	—	$V_{VBAT} + 0.3$	V	*2
	LDO6	-0.3	—	$V_{VBAT} + 0.3$	V	*2

Note) Do not apply external currents and voltages to any pin not specifically mentioned.

Voltage values, unless otherwise specified, are with respect to GND. GND is voltage for AGND, DDGND1 = DDGND2  
 $V_{VBAT}$  is voltage for DDVBAT1, DDVBAT2, VB = VIN2.  $V_{DVDD}$  is voltage for DVDD.

\*1 : The values under the condition not exceeding the above absolute maximum ratings and the power dissipation.

\*2 : ( $V_{VBAT} + 0.3$ ) V must not be exceeded 6 V. ( $V_{DVDD} + 0.3$ ) V must not be exceeded 3.6 V.

**ELECTRICAL CHARACTERISTICS**

$V_{VBAT}(DDVBAT1 = DDVBAT2 = VB = VIN2) = 3.7V, V_{DVDD} = 1.85V$

DC-DC :  $C_o = 4.7 \mu F, L_o = 1 \mu H$  / LDO :  $C_o = 1.0 \mu F$

$T_a = 25 \text{ }^\circ\text{C} \pm 2 \text{ }^\circ\text{C}$  unless otherwise noted.

Parameter	Symbol	Conditions	Limits			Unit	Notes
			Min	Typ	Max		
[ Consumption current ]							
Consumption current 1 on active	IBAT_1	only LDO1 (PS mode) ON	—	10	20	$\mu A$	—
Consumption current 2 on active	IBAT_2	DCDC1-2, LDO1-6 = ON	—	360	600	$\mu A$	—
Static consumption current	IBAT_3	DCDC1-2, LDO1-6 = OFF	—	0.1	1.0	$\mu A$	—

**ELECTRICAL CHARACTERISTICS (Continued)**

$V_{VBAT}(DDVBAT1 = DDVBAT2 = VB = VIN2) = 3.7V$ ,  $V_{DVDD} = 1.85V$

DC-DC :  $C_o = 4.7 \mu F$ ,  $L_o = 1 \mu H$  / LDO :  $C_o = 1.0 \mu F$

$T_a = 25 \text{ }^\circ\text{C} \pm 2 \text{ }^\circ\text{C}$  unless otherwise noted.

Parameter	Symbol	Conditions	Limits			Unit	Notes
			Min	Typ	Max		
[ LDO1 – 6 ( Normal Mode ) ] (LDO Regulator)							
Output voltage	VLDO	ILDO = – 150 mA Vout = 1.85 V setting	1.803	1.850	1.897	V	—
Output current	ILDO	—	300	—	—	mA	—
Load regulation	DVLDO	$\Delta$ ILDO = – 10 $\mu$ A $\rightarrow$ – 150 mA	–5	20	50	mV	—
Line regulation	VLDOLR	VB = 3.1 V $\rightarrow$ 4.5 V ILDO = – 150 mA Vout = 1.85 V setting	– 10	0	10	mV	—
Short-circuit current	ISTLDO	VB = 3.7 V VLDO = 0 V	35	100	255	mA	—
[ LDO1 – 6 ( Power Save Mode ) ] (LDO Regulator)							
Output voltage	VLDOPS	ILDO = – 5 mA Vout = 1.85 V setting	1.803	1.850	1.897	V	—
Output current	ILDOPS	—	10	—	—	mA	—
Load regulation	DVLDOPS	$\Delta$ ILDO = – 10 $\mu$ A $\rightarrow$ – 5 mA	– 5	20	50	mV	—
Line regulation	VLDOLRPS	VB = 3.1 V $\rightarrow$ 4.5 V ILDO = – 5 mA Vout = 1.85 V setting	– 25	0	25	mV	—

**ELECTRICAL CHARACTERISTICS (Continued)**

$V_{VBAT}(DDVBAT1 = DDVBAT2 = VB = VIN2) = 3.7V$ ,  $V_{DVDD} = 1.85V$

DC-DC :  $C_o = 4.7 \mu F$ ,  $L_o = 1 \mu H$  / LDO :  $C_o = 1.0 \mu F$

$T_a = 25 \text{ }^\circ\text{C} \pm 2 \text{ }^\circ\text{C}$  unless otherwise noted.

Parameter	Symbol	Conditions	Limits			Unit	Notes
			Min	Typ	Max		
[ DCDC1 ] (DC-DC Step Down Regulator)							
Output voltage	VDCDC1	IDCDC1 = - 300 mA Vout = 1.2 V setting	1.170	1.200	1.230	V	—
Output current	IDCDC1	—	600	—	—	mA	—
Load regulation	DVDCDC1	$\Delta$ IDCDC1 = - 10 $\mu$ A $\rightarrow$ - 500 mA Vout = 1.2 V setting	—	25	45	mV	—
Line regulation	VDCDC1LR	DDVBAT1 = 3.1 V $\rightarrow$ 4.5 V IDCDC1 = - 300 mA Vout = 1.2 V setting	—	4	13	mV	—
Oscillation frequency	ISTDCDC1	IDCDC1 = - 300 mA (CCM)	2	3	4	MHz	—
[ DCDC2 ] (DC-DC Step Down Regulator)							
Output voltage	VDCDC2	IDCDC2 = - 300 mA Vout = 1.85 V setting	1.803	1.850	1.897	V	—
Output current	IDCDC2	—	600	—	—	mA	—
Load regulation	DVDCDC2	$\Delta$ IDCDC2 = - 10 $\mu$ A $\rightarrow$ - 500 mA Vout = 1.85 V setting	—	25	45	mV	—
Line regulation	VDCDC2LR	DDVBAT2 = 3.1 V $\rightarrow$ 4.5 V IDCDC2 = - 300 mA Vout = 1.85 V setting	—	4	13	mV	—
Oscillation frequency	ISTDCDC2	IDCDC2 = - 300 mA (CCM)	2	3	4	MHz	—
[ I/O characteristics of control terminal (RESET, LDO1ON) ]							
Low input voltage	VIL1	Voltage recognized as low level	—	—	0.45	V	—
High input voltage	VIH1	Voltage recognized as high level	1.2	—	—	V	—
Input pull-down resistance	PDR1	—	1	3	6	M $\Omega$	—
[ I/O characteristics of control terminal (ASEL) ]							
Low input voltage	VIL2	Voltage recognized as low level	—	—	$V_{DVDD} \times 0.3$	V	—
High input voltage	VIH2	Voltage recognized as high level	$V_{DVDD} \times 0.7$	—	—	V	—

**APPLICATION INFORMATION**

$V_{VBAT}(DDVBAT1 = DDVBAT2 = VB = VIN2) = 3.7V, V_{DVDD} = 1.85V$

$T_a = 25\text{ }^\circ\text{C} \pm 2\text{ }^\circ\text{C}$  unless otherwise noted.

Parameter	Symbol	Conditions	Reference values			Unit	Notes
			Min	Typ	Max		
[I <sup>2</sup> C Bus (Internal I/O Stage Characteristics) ]							
Low-level input voltage	VIL1	Voltage which recognized that SDA and SCL are Low-level	- 0.5	—	$0.3 \times V_{DVDD}$	V	*1 *2
High-level input voltage	VIH1	Voltage which recognized that SDA and SCL are High-level	$0.7 \times V_{DVDD}$	—	$V_{DVDDmax} + 0.5$	V	*1 *2
Low-level output voltage 1	VOL1	$V_{DVDD} > 2\text{ V}$ SDA(sink current) = 3 mA	0	—	0.4	V	*2
Low-level output voltage 2	VOL2	$V_{DVDD} < 2\text{ V}$ SDA(sink current) = 3 mA	0	—	$0.2 \times V_{DVDD}$	V	*2
Input current each I/O pin	IL	SCL, SDA = $0.1 \times V_{DVDDmax}$ to $0.9 \times V_{DVDDmax}$	- 10	—	10	μA	*2
SCL clock frequency	FOSC	—	0	—	400	kHz	*2

Notes) \*1 : The input threshold voltage of I<sup>2</sup>C bus (V<sub>th</sub>) is linked to V<sub>DVDD</sub>.

In case the pull-up voltage is not V<sub>DVDD</sub>, the threshold voltage (V<sub>th</sub>) is fixed to  $((V_{DVDD} / 2) \pm (\text{Schmitt width}) / 2)$  and High-level, Low-level of input voltage are not specified.

In this case, pay attention to Low-level (max.) value (V<sub>ILmax</sub>).

It is recommended that the pull-up voltage of I<sup>2</sup>C bus is set to the I<sup>2</sup>C bus I/O stage supply voltage (V<sub>DVDD</sub>).

\*2 :Checked by design, not production tested.

**APPLICATION INFORMATION (Continued)**

$V_{VBAT}(DDVBAT1 = DDVBAT2 = VB = VIN2) = 3.1V$  to  $4.5V$ ,  $V_{DVDD} = 1.85V$

DC-DC :  $C_o = 4.7 \mu F$ ,  $L_o = 1 \mu H$  / LDO :  $C_o = 1.0 \mu F$

$T_a = 25 \text{ }^\circ\text{C} \pm 2 \text{ }^\circ\text{C}$  unless otherwise noted.

Parameter	Symbol	Conditions	Reference values			Unit	Notes
			Min	Typ	Max		
[ LDO1 – 6 ( Normal Mode ) ] (LDO Regulator)							
Output voltage	VLDO	ILDO = – 150 mA Vout = 1.85 V setting	1.803	1.850	1.897	V	*2
Consumption current on active	IREGLDO	Normal mode VB > Vout + 0.1 V or VIN2 > Vout + 0.1 V	25	50	75	$\mu A$	*2
I/O voltage difference	VSATLDO	ILDO = – 300 mA	0.3	—	—	V	*2
Ripple rejection	VLDORR	$\Delta VB = 3.7 V \pm 0.15 V$ ILDO = – 150 mA fvin = 100 Hz to 10 kHz	—	– 60	– 40	dB	*2
Discharge resistance	RDISLDO	—	50	100	200	$k\Omega$	*2
Load change characteristic	LTRLDO	ILDO = – 10 $\mu A$ $\leftrightarrow$ – 100 mA	—	30	150	mV	*2
[ LDO1 – 6 ( Power Save Mode ) ] (LDO Regulator)							
Output voltage	VLDOPS	ILDO = – 5 mA Vout = 1.85 V setting	1.803	1.850	1.897	V	*2
Consumption current on active	IREGLDOPS	Power Save mode VB > Vout + 0.1 V or VIN2 > Vout + 0.1 V	1	3	5	$\mu A$	*2
Ripple rejection	VLDOPSRR	$\Delta VB = 3.7 V \pm 0.15 V$ ILDO = – 5 mA fvin = 100 Hz to 10 kHz	—	– 10	– 5	dB	*2
Short-circuit current	ISTLDOPS	VB = 3.7 V VLDO = 0 V	5	20	40	mA	*2

Notes) \*2:Checked by design, not production tested.



**APPLICATION INFORMATION (Continued)**

$V_{VBAT}(DDVBAT1 = DDVBAT2 = VB = VIN2) = 3.1V$  to  $4.5V$ ,  $V_{DVDD} = 1.85V$

DC-DC :  $C_o = 4.7 \mu F$ ,  $L_o = 1 \mu H$  / LDO :  $C_o = 1.0 \mu F$

$T_a = 25 \text{ }^\circ\text{C} \pm 2 \text{ }^\circ\text{C}$  unless otherwise noted.

Parameter	Symbol	Conditions	Reference values			Unit	Notes
			Min	Typ	Max		
<b>[DCDC1 ] (DC-DC Step Down Regulator)</b>							
Output Voltage	VDCDC1	IDCDC1 = - 300 mA Vout = 1.2 V setting	1.17	1.200	1.23	V	*2
Consumption current on active	IREGDCCD1	IDCDC1 = 0 mA	10	25	40	$\mu A$	*2
Output over current limit	ILIMDCDC1	From FB1 $\times$ 100% to FB1 $\times$ 70% VB = 3.7 V	—	1.0	1.2	A	*2
Efficiency 1	EFFDCDC11	DDVBAT1 = 3.4 V VDCDC1 = 2.4 V IDCDC1 = - 150 mA	85	90	—	%	*2
Efficiency 2	EFFDCDC12	DDVBAT1 = 3.7 V VDCDC1 = 1.2 V IDCDC1 = - 150 mA	75	80	—	%	*2
LX leak current	ILXL1	DDVBAT1 = 5.5 V DCDC1 = Disable VLX1 = 0 V or 5.5 V	-1	0	1	$\mu A$	*2
Discharge resistance	RDISDCDC1	—	0.5	1.0	2.0	k $\Omega$	*2
<b>[DC-DC2 ] (DC-DC Step Down Regulator)</b>							
Output Voltage	VDCDC2	IDCDC2 = - 300 mA Vout = 1.85 V setting	1.803	1.850	1.897	V	*2
Consumption current on active	IREGDCCD2	IDCDC2 = 0 mA	10	25	40	$\mu A$	*2
Output overcurrent limit	ILIMDCDC2	From FB2 $\times$ 100% to FB2 $\times$ 70% VB = 3.7 V	—	1.0	1.2	A	*2
Efficiency 1	EFFDCDC21	DDVBAT2 = 3.4 V VDCDC2 = 2.4 V IDCDC2 = - 150 mA	85	90	—	%	*2
Efficiency 2	EFFDCDC22	DDVBAT2 = 3.7 V VDCDC2 = 1.85 V IDCDC2 = - 150 mA	80	85	—	%	*2
LX leak current	ILXL2	DDVBAT2 = 5.5 V DCDC2 = Disable VLX2 = 0 V or 5.5 V	-1	0	1	$\mu A$	*2
Discharge resistance	RDISDCDC2	—	0.5	1.0	2.0	k $\Omega$	*2

Notes) \*2:Checked by design, not production tested.

**APPLICATION INFORMATION (Continued)**

$V_{VBAT}(DDVBAT1 = DDVBAT2 = VB = VIN2) = 3.1V$  to  $4.5V$ ,  $V_{DVDD} = 1.85V$

DC-DC :  $C_o = 4.7 \mu F$ ,  $L_o = 1 \mu H$  / LDO :  $C_o = 1.0 \mu F$

$T_a = 25 \text{ }^\circ\text{C} \pm 2 \text{ }^\circ\text{C}$  unless otherwise noted.

Parameter	Symbol	Conditions	Reference values			Unit	Notes
			Min	Typ	Max		
[ I <sup>2</sup> C bus (Internal I/O stage characteristics) ]							
Hysteresis of Schmitt trigger input 1	Vhys1	$V_{IO} > 2 V$ , Hysteresis 1 of SDA, SCL	$0.05 \times V_{DVDD}$	—	—	V	*2
Hysteresis of Schmitt trigger input 2	Vhys2	$V_{IO} < 2 V$ , Hysteresis 2 of SDA, SCL	$0.1 \times V_{DVDD}$	—	—	V	*2
Output fall time from $V_{IHmin}$ to $V_{ILmax}$	Tof	Bus capacitance : 10 pF to 400 pF $I_P \leq 6 \text{ mA}$ ( $V_{OLmax} = 0.6 V$ ) $I_P$ : Max. sink current	$20 + 0.1 \times C_b$	—	250	ns	*2
Pulse width of spikes which must be suppressed by the input filter	Tsp	—	0	—	50	ns	*2
Capacitance for each I/O pin	Ci	—	—	—	10	pF	*2
[ I <sup>2</sup> C bus (Bus line specifications) ]							
Hold time (repeated) START condition	$t_{HD:STA}$	The first clock pulse is generated after $t_{HD:STA}$ .	0.6	—	—	$\mu s$	*2
Low period of the SCL clock	$t_{LOW}$	—	1.3	—	—	$\mu s$	*2
High period of the SCL clock	$t_{HIGH}$	—	0.6	—	—	$\mu s$	*2
Set-up time for a repeat START condition	$t_{SU:STA}$	—	0.6	—	—	$\mu s$	*2
Data hold time	$t_{HD:DAT}$	—	0	—	0.9	$\mu s$	*2
Data set-up time	$t_{SU:DAT}$	—	100	—	—	ns	*2
Rise time of both SDA and SCL signals	$t_r$	—	$20 + 0.1 \times C_b$	—	300	ns	*2
Fall time of both SDA and SCL signals	$t_f$	—	$20 + 0.1 \times C_b$	—	300	ns	*2
Set-up time of STOP condition	$t_{SU:STO}$	—	0.6	—	—	$\mu s$	*2
Bus free time between STOP and START condition	$t_{BUF}$	—	1.3	—	—	$\mu s$	*2

Notes) \*2 : Checked by design, not production tested.

**APPLICATION INFORMATION (Continued)**

$V_{VBAT}(DDVBAT1 = DDVBAT2 = VB = VIN2) = 3.1V$  to  $4.5V$ ,  $V_{DVDD} = 1.85V$

DC-DC :  $C_o = 4.7 \mu F$ ,  $L_o = 1 \mu H$  / LDO :  $C_o = 1.0 \mu F$

$T_a = 25 \text{ }^\circ\text{C} \pm 2 \text{ }^\circ\text{C}$  unless otherwise noted.

Parameter	Symbol	Conditions	Reference values			Unit	Notes
			Min	Typ	Max		
[ I <sup>2</sup> C bus (Bus line specifications) (continued) ]							
Capacitive load for each bus line	$C_b$	—	—	—	400	pF	*2 *3
Noise margin at the Low-level for each connected device	$V_{nL}$	—	$0.1 \times V_{DVDD}$	—	—	V	*2 *3
Noise margin at the High-level for each connected device	$V_{nH}$	—	$0.2 \times V_{DVDD}$	—	—	V	*2 *3

\*2 : Checked by design, not production tested.

\*3 : Checked by design, not production tested.

The timing of Fast-mode devices in I<sup>2</sup>C-bus is specified as the following.

All values referred to  $V_{IHmin}$  and  $V_{ILmax}$  level.

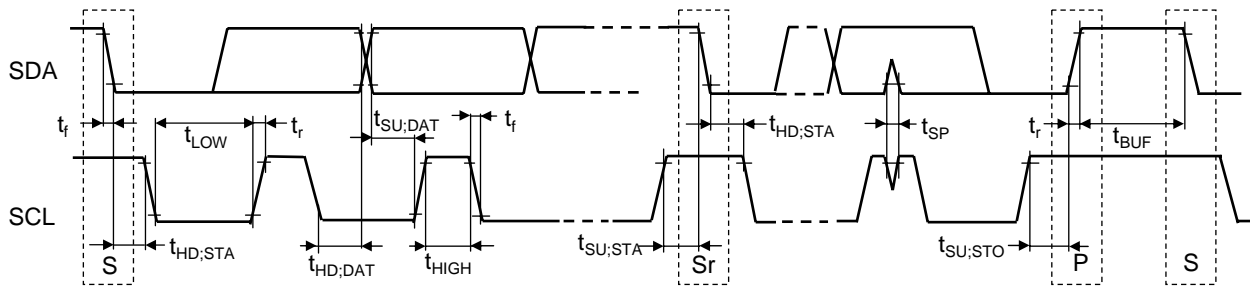

S : START condition

Sr : Repeat START condition

P : STOP condition

**PIN CONFIGURATION**

BOTTOM VIEW

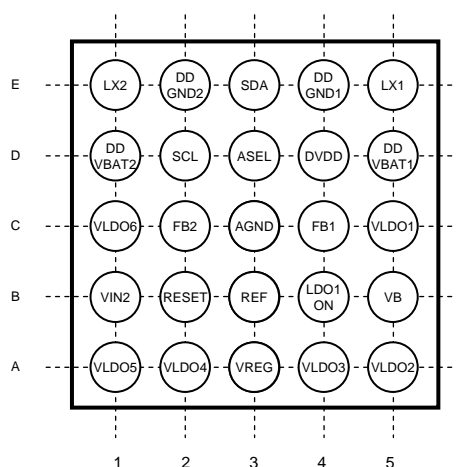

**PIN FUNCTIONS**

Pin No.	Pin name	Type	Description
A1	VLDO5	Output	LDO5 output
A2	VLDO4	Output	LDO4 output
A3	VREG	Output	Reference output
A4	VLDO3	Output	LDO3 output
A5	VLDO2	Output	LDO2 output
B1	VIN2	Power Supply	Input for LDO4, LDO5, and LDO6
B2	RESET	Input	Reset input for Logic
B3	REF	Output	Reference output
B4	LDO1ON	Input	LDO1 ON/OFF control
B5	VB	Power Supply	Input for LDO1, LDO2, LDO3, and other VB
C1	VLDO6	Output	LDO6 output
C2	FB2	Input	DCDC2 voltage feedback
C3	AGND	Ground	GND
C4	FB1	Input	DCDC1 voltage feedback
C5	VLDO1	Output	LDO1 output
D1	DDVBAT2	Power Supply	DCDC2 input
D2	SCL	Input	I <sup>2</sup> C clock input
D3	ASEL	Input	I <sup>2</sup> C slave address select
D4	DVDD	Power Supply	Power supply for Logic
D5	DDVBAT1	Power Supply	DCDC1 input
E1	LX2	Output	DCDC2 switching
E2	DDGND2	Ground	GND
E3	SDA	Input/Output	I <sup>2</sup> C data input/output
E4	DDGND1	Ground	GND
E5	LX1	Output	DCDC1 switching

Notes) Concerning detail about pin description, please refer to OPERATION and APPLICATION INFORMATION section.

FUNCTIONAL BLOCK DIAGRAM

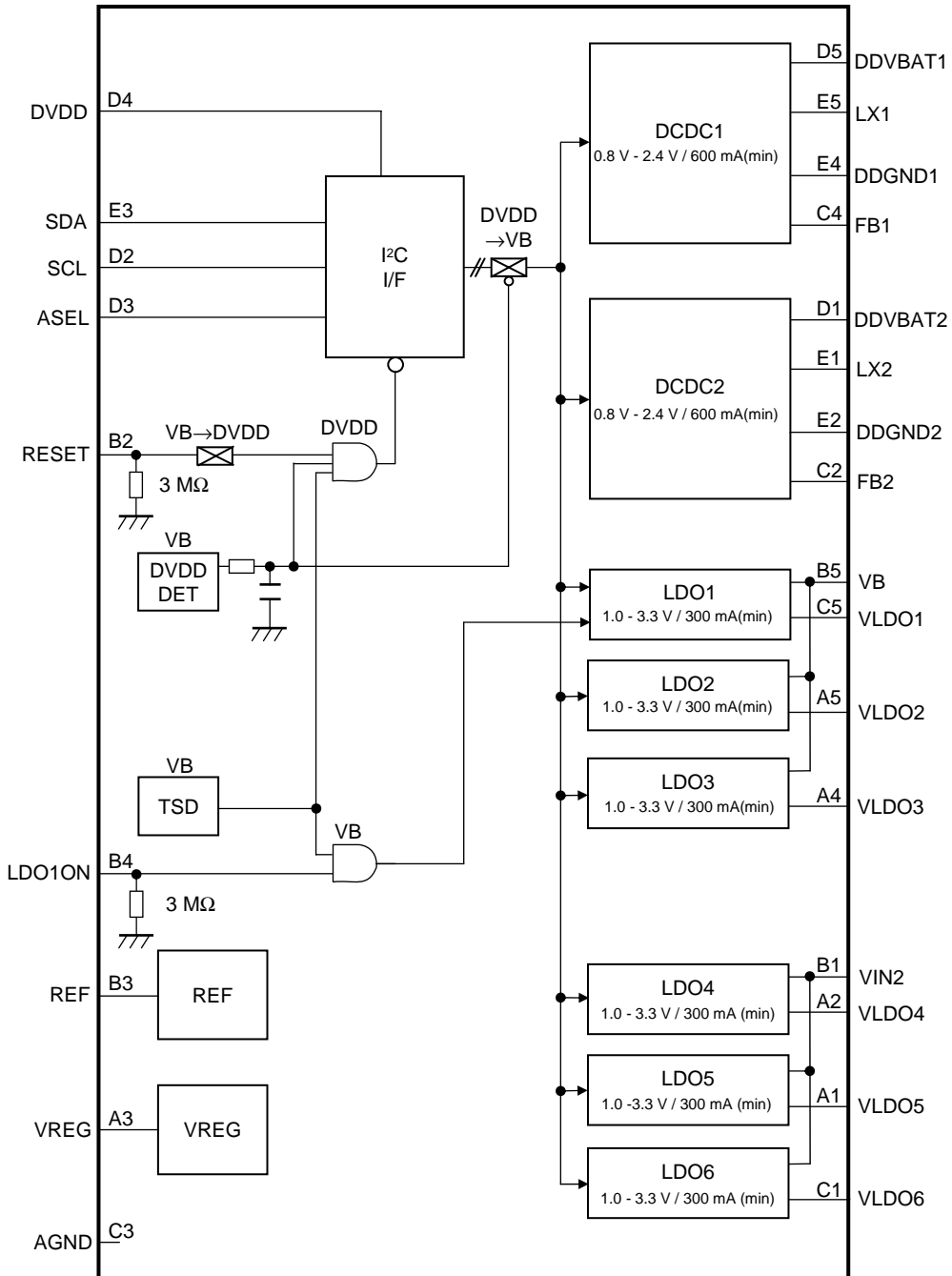

Notes) This block diagram is for explaining functions. Part of the block diagram may be omitted, or it may be simplified.

TYPICAL CHARACTERISTICS CURVES

(1) Output Ripple Voltage of DC-DC1 and DC-DC2

$V_{IN} = 3.7\text{ V}$ , DC-DC1\_Vout = 1.2 V, DC-DC2\_Vout=1.85V,  $L1 = L2 = 1\ \mu\text{H}$ , CDCDCOUT1 = CDCDCOUT2 = 4.7  $\mu\text{F}$

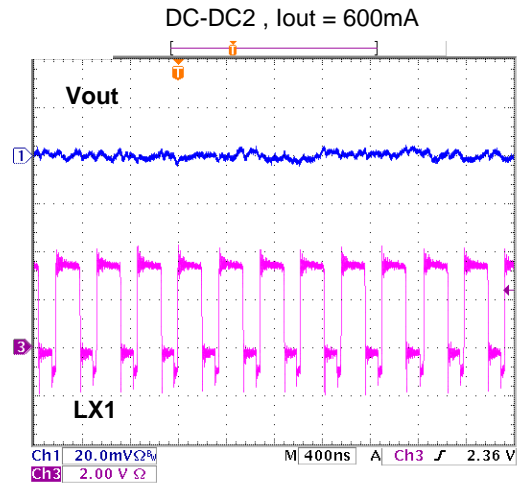
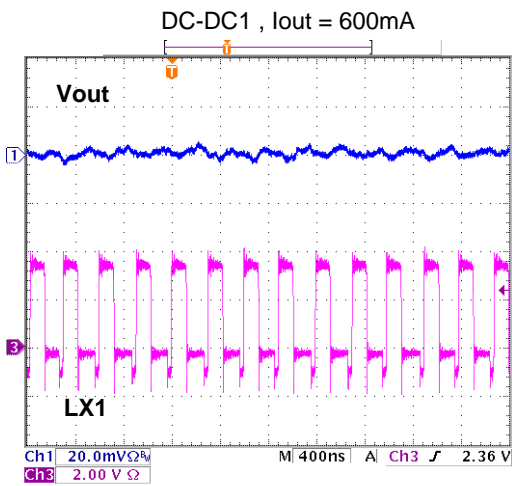
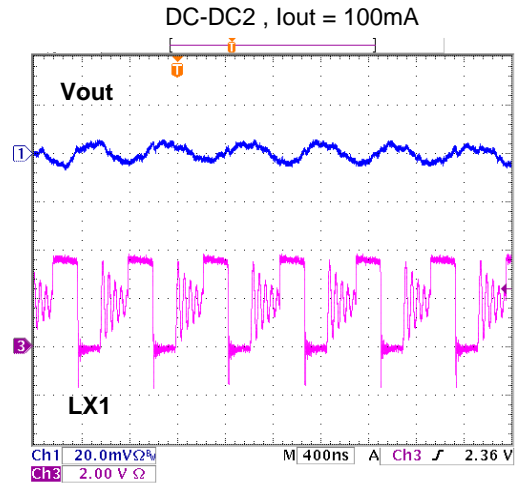
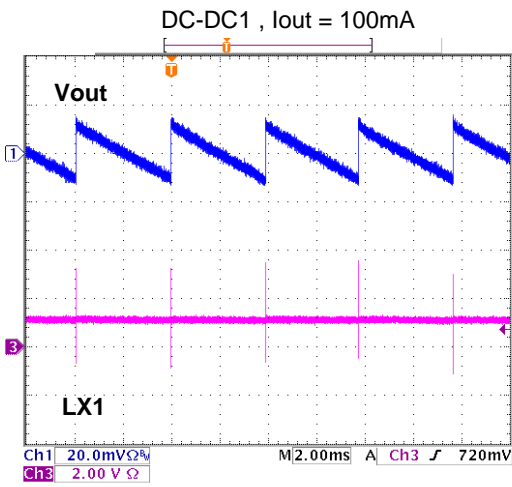
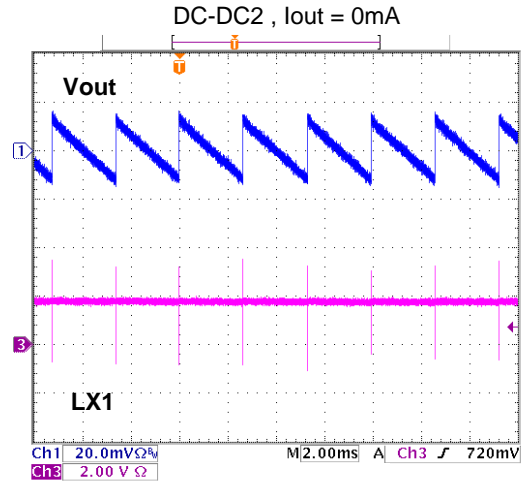
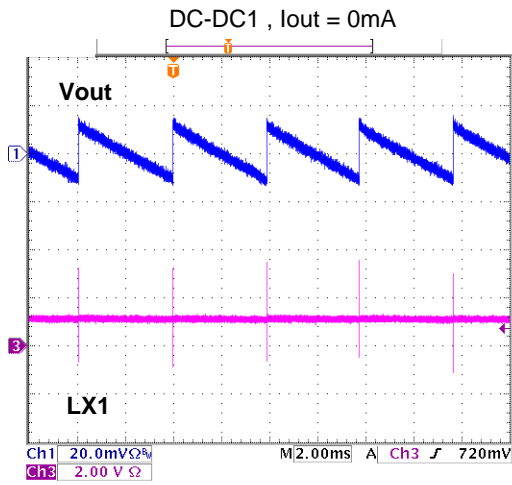

TYPICAL CHARACTERISTICS CURVES (Continued)

(2) Load Transient of DC-DC1 and DC-DC2

$V_{IN} = 3.7\text{ V}$ , DC-DC1\_Vout = 1.2 V, DC-DC2\_Vout=1.85V,  $L1 = L2 = 1\ \mu\text{H}$ , CDCDCOUT1 = CDCDCOUT2 = 4.7  $\mu\text{F}$

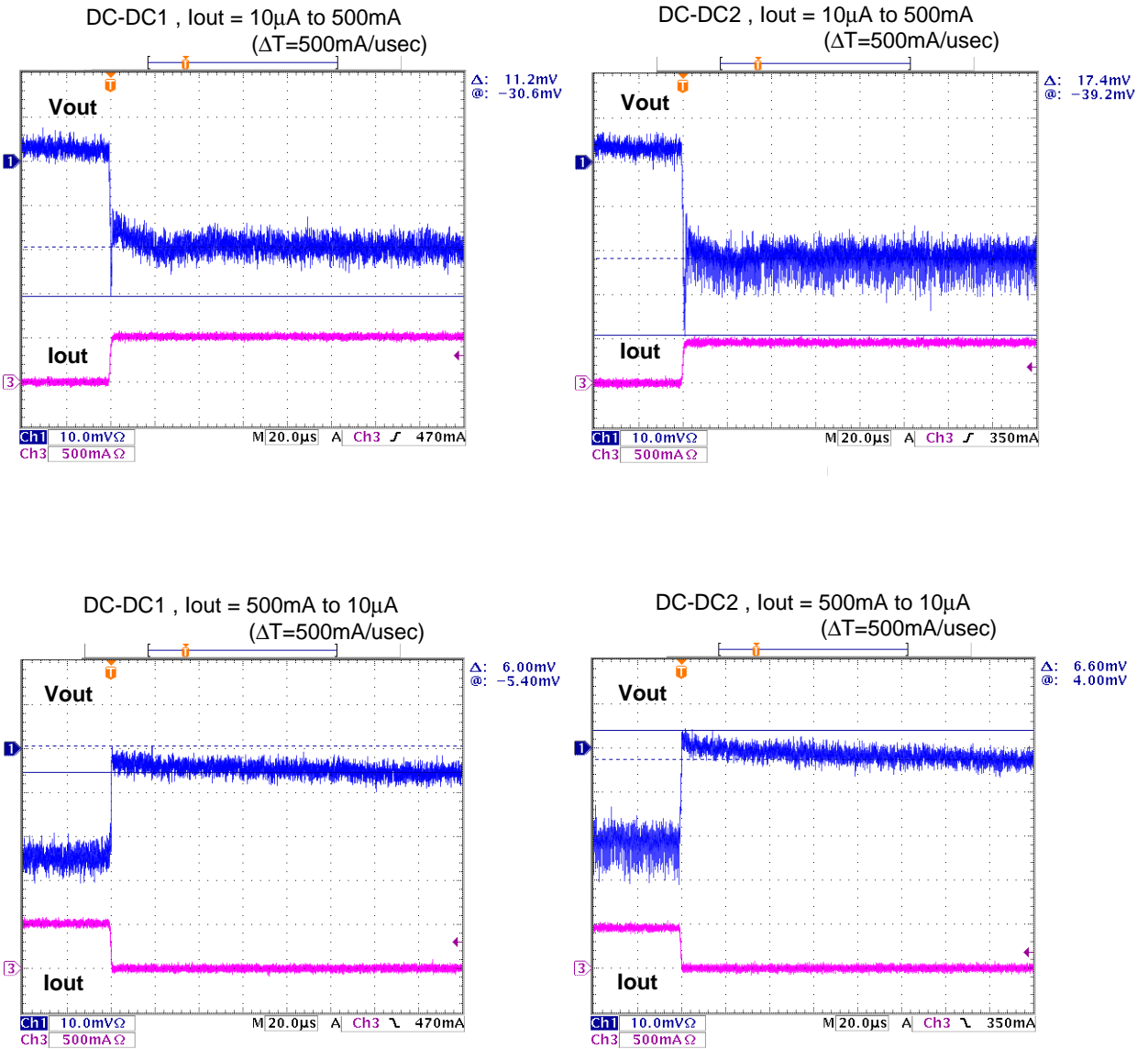

TYPICAL CHARACTERISTICS CURVES (Continued)

(3) Efficiency of DC-DC1 and DC-DC2

$V_{IN} = 3.7\text{ V}$ , DC-DC1\_Vout = 1.2 V, DC-DC2\_Vout=1.85V ,  $L1 = L2 = 1\ \mu\text{H}$  , CDCDCOUT1 = CDCDCOUT2 = 4.7  $\mu\text{F}$

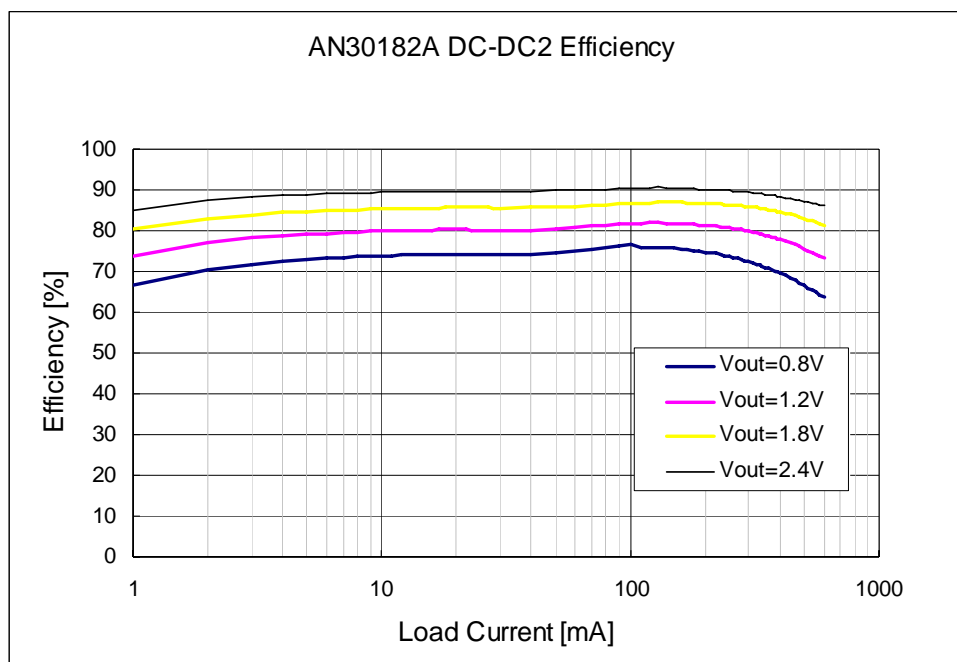
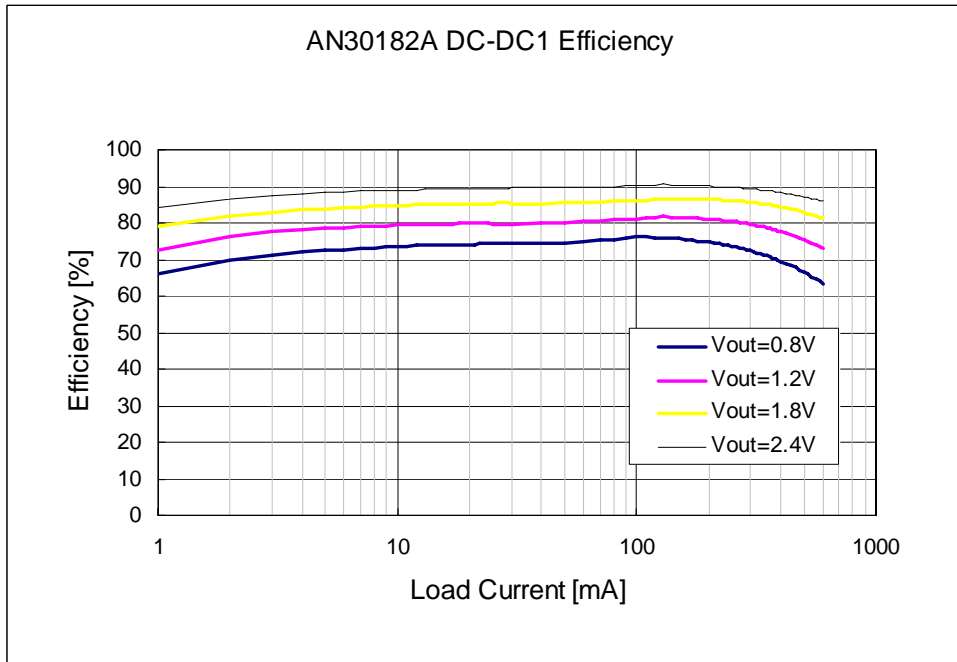



TYPICAL CHARACTERISTICS CURVES (Continued)

(4) Load Regulation of DC-DC1 and DC-DC2

$V_{IN} = 3.7\text{ V}$ , DC-DC1\_Vout = 1.2 V, DC-DC2\_Vout=1.85V ,  $L1 = L2 = 1\ \mu\text{H}$  , CDCDCOUT1 = CDCDCOUT2 = 4.7  $\mu\text{F}$

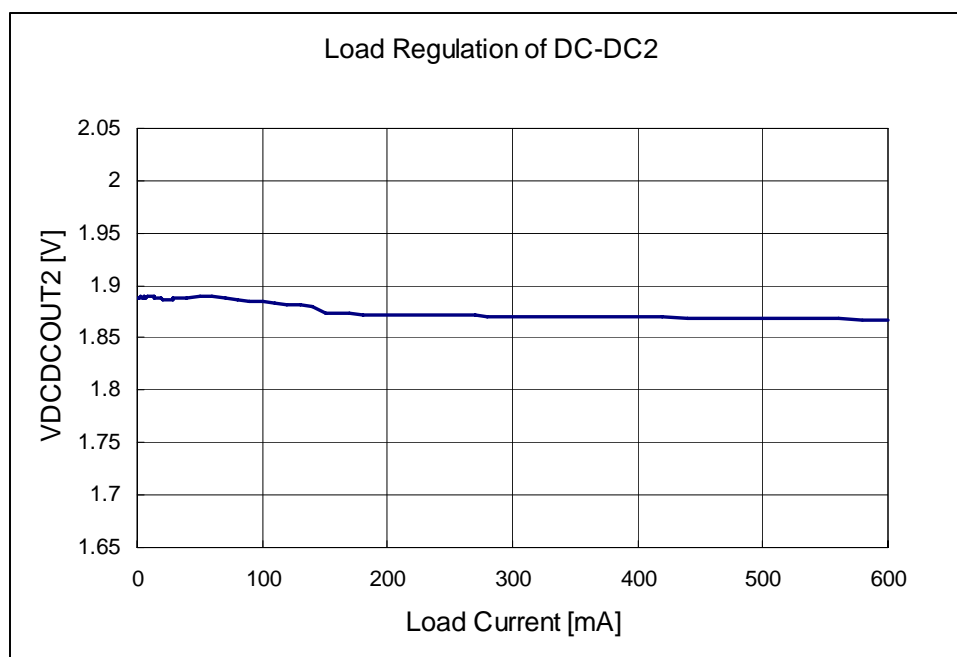
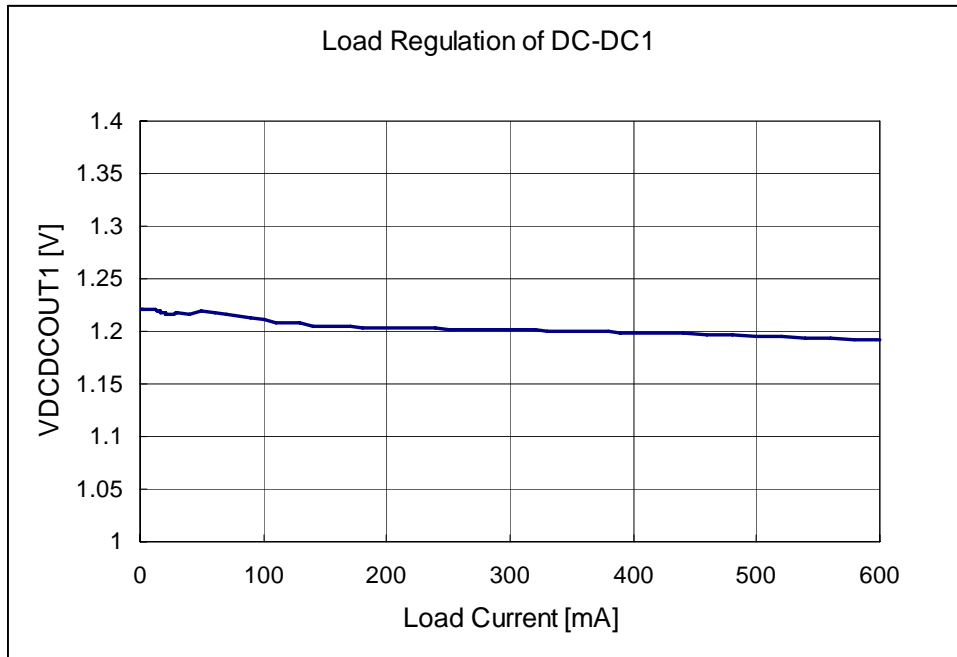

TYPICAL CHARACTERISTICS CURVES (Continued)

(5) Line Regulation of DC-DC1 and DC-DC2

$I_{out} = 300\text{mA}$ , DC-DC1\_Vout = 1.2 V, DC-DC2\_Vout=1.85V ,  $L1 = L2 = 1 \mu\text{H}$

CDCDCOUT1 = CDCDCOUT2 = 4.7  $\mu\text{F}$

$V_{IN} = 2.4\text{V to } 5.5\text{V}$

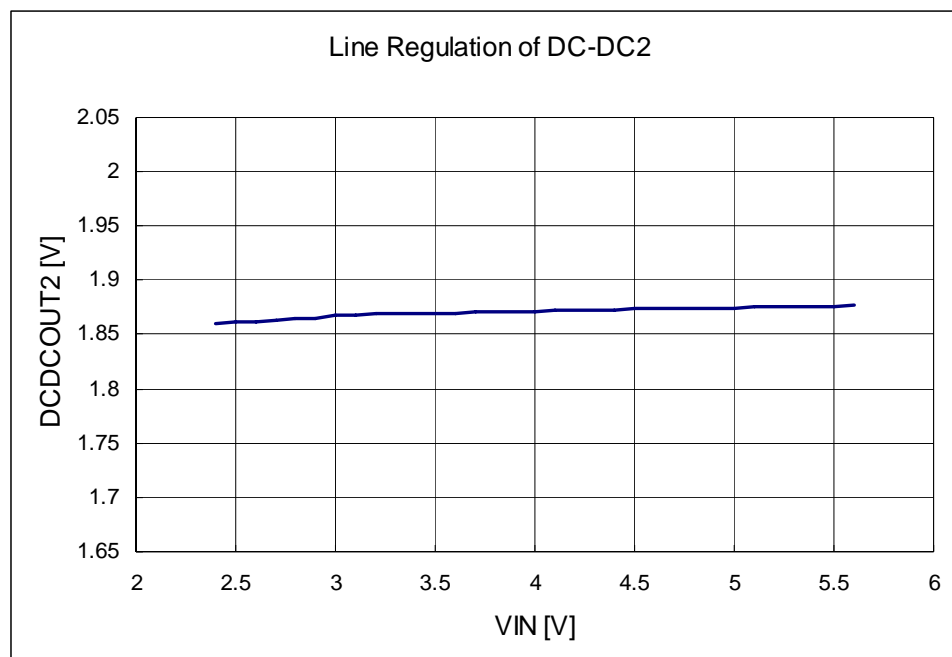
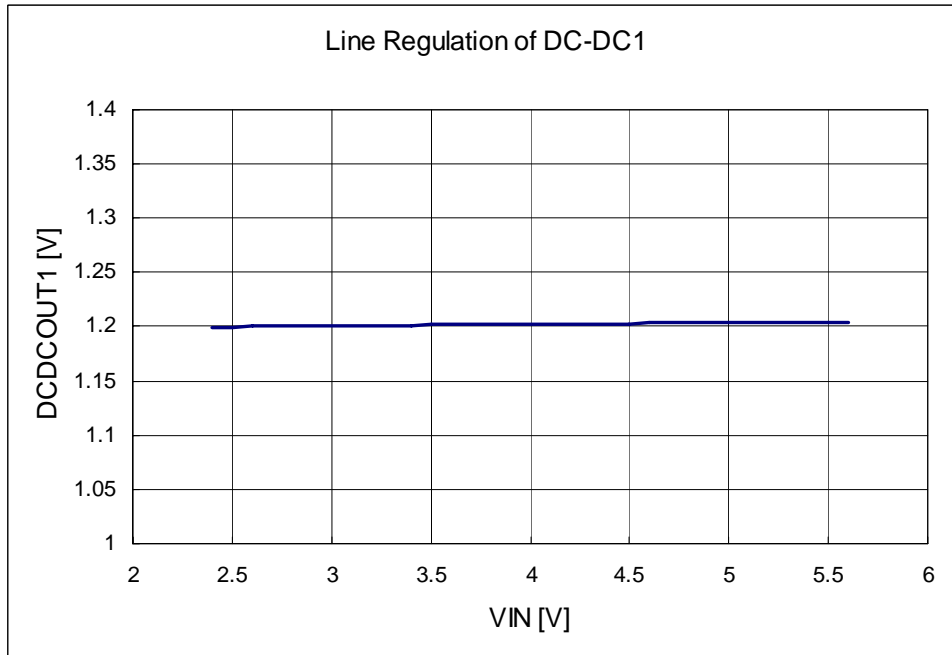

TYPICAL CHARACTERISTICS CURVES (Continued)

(6) Start Up & Shut Down of DC-DC1 and DC-DC2

$V_{IN} = 3.7\text{ V}$ , DC-DC1\_Vout = 1.2 V, DC-DC2\_Vout=1.85V,  $L1 = L2 = 1\ \mu\text{H}$ , CDCDCOUT1 = CDCDCOUT2 = 4.7  $\mu\text{F}$

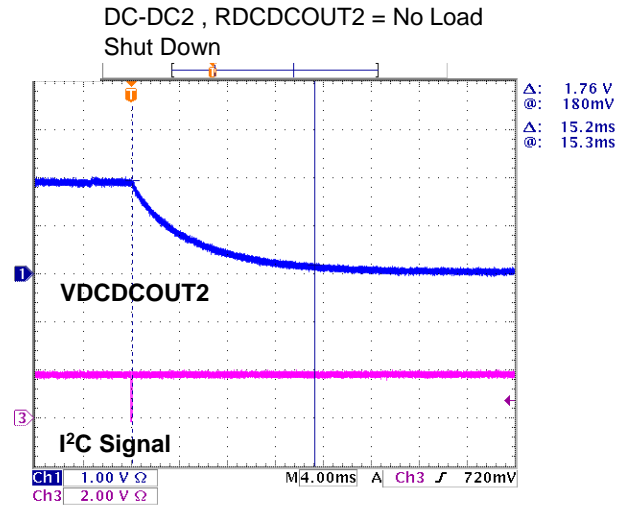
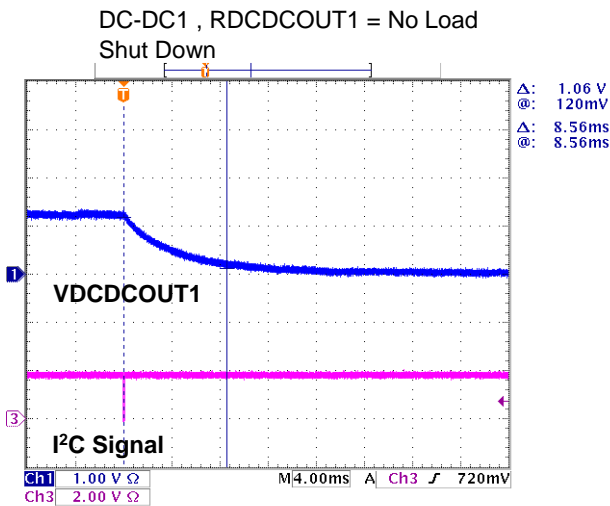
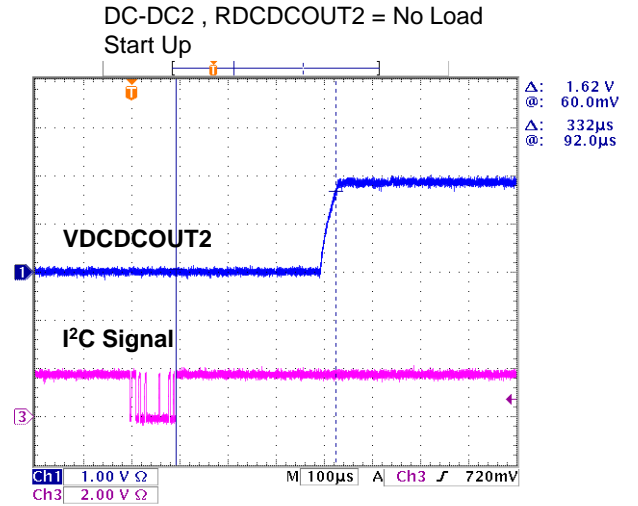
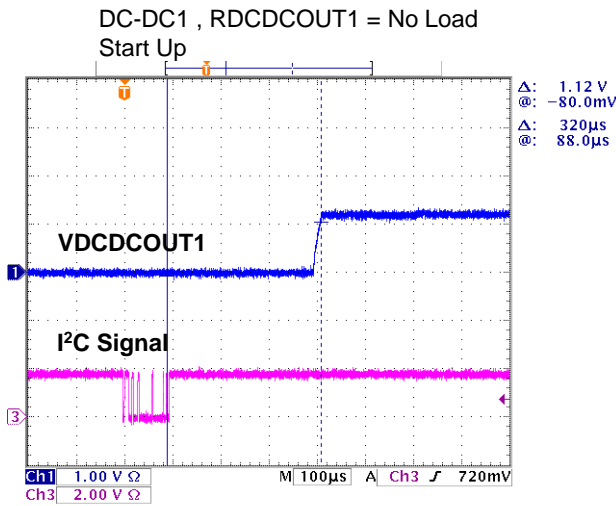

TYPICAL CHARACTERISTICS CURVES (Continued)

(7) Start Up & Shut Down of DC-DC1 and DC-DC2

$V_{IN} = 3.7\text{ V}$ ,  $DC\text{-}DC1\_V_{out} = 1.2\text{ V}$ ,  $DC\text{-}DC2\_V_{out} = 1.85\text{ V}$ ,  $L1 = L2 = 1\ \mu\text{H}$ ,  $CDCDCOUT1 = CDCDCOUT2 = 4.7\ \mu\text{F}$

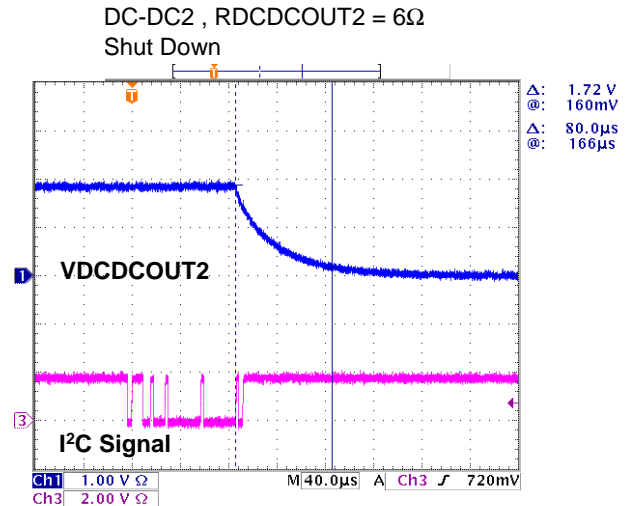
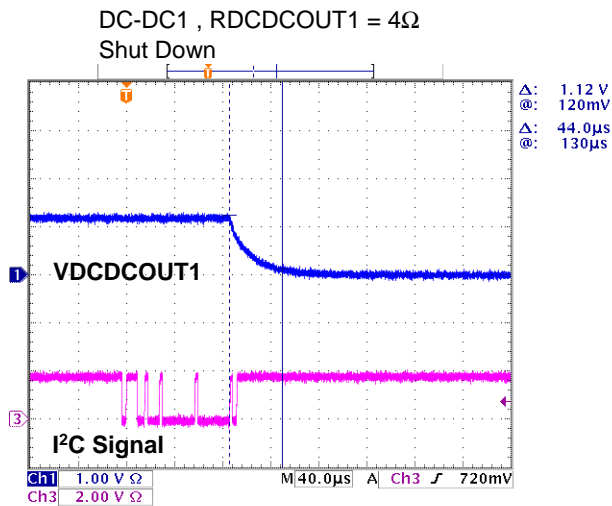
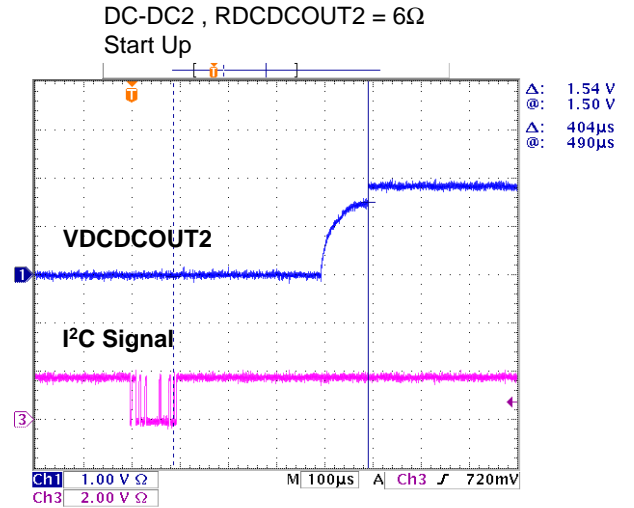
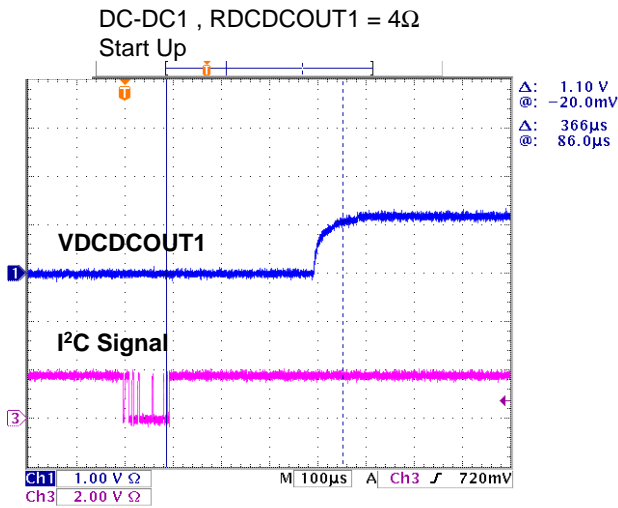

TYPICAL CHARACTERISTICS CURVES (Continued)

(8) Short Protection of DC-DC1

$V_{IN} = 3.7\text{ V}$ ,  $DC\text{-}DC1\_V_{out} = 1.2\text{ V}$ ,  $L1 = 1\text{ }\mu\text{H}$ ,  $CDCDCOUT1 = 4.7\text{ }\mu\text{F}$

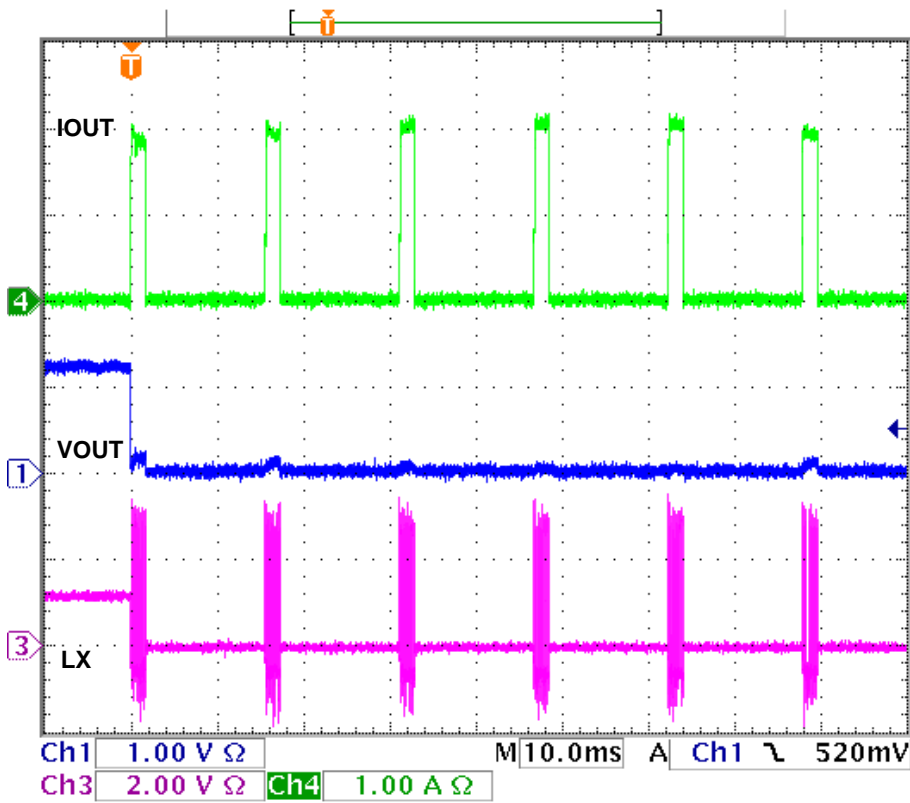

TYPICAL CHARACTERISTICS CURVES (Continued)

(9) Thermal Performance of DC-DC1

$V_{IN} = 3.7\text{ V}$ , DC-DC1\_Vout = 1.2 V, ILoad = 600mA , L1 = 1  $\mu\text{H}$  , CDCDCOUT1 = 4.7  $\mu\text{F}$

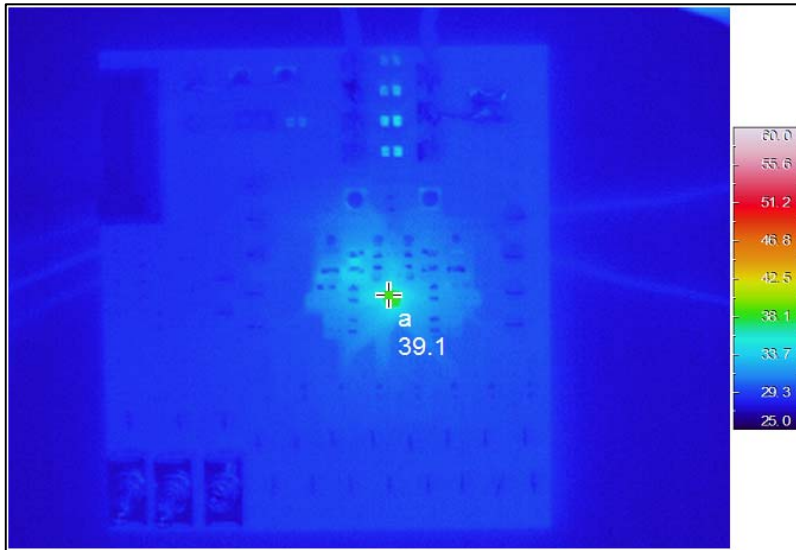

(10) Thermal Performance of DC-DC2

$V_{IN} = 3.7\text{ V}$ , DC-DC2\_Vout = 1.85 V, ILoad = 600mA , L2 = 1  $\mu\text{H}$  , CDCDCOUT2 = 4.7  $\mu\text{F}$

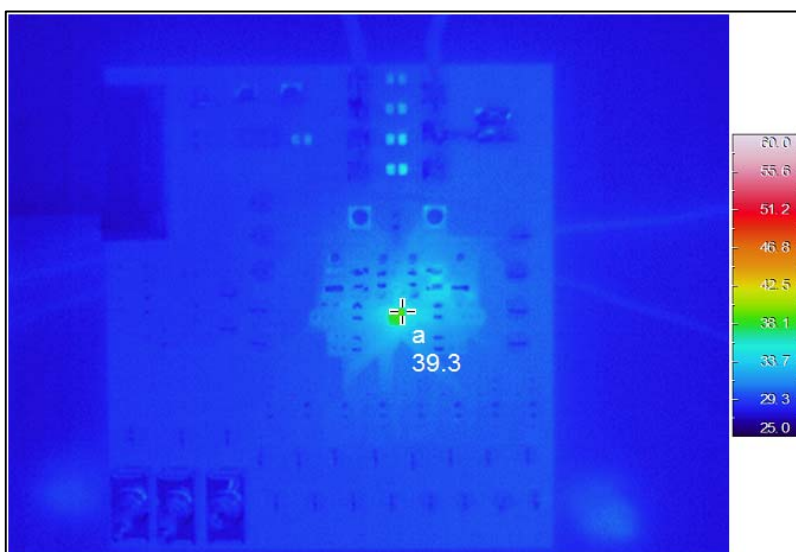

TYPICAL CHARACTERISTICS CURVES (Continued)

(11) Frequency of DC-DC1 and DC-DC2

$V_{IN} = 3.7\text{ V}$ , DC-DC1\_Vout = 1.2 V, DC-DC2\_Vout=1.85V,  $L1 = L2 = 1\ \mu\text{H}$ , CDCDCOUT1 = CDCDCOUT2 = 4.7  $\mu\text{F}$

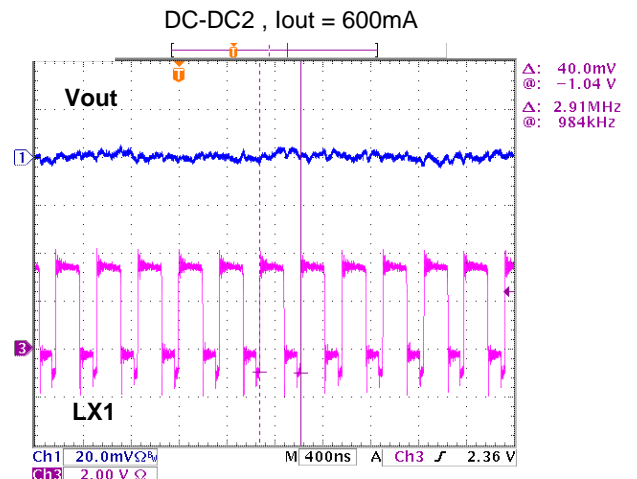
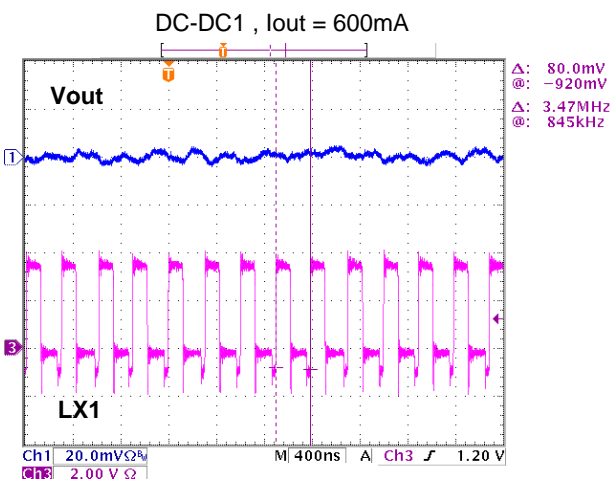
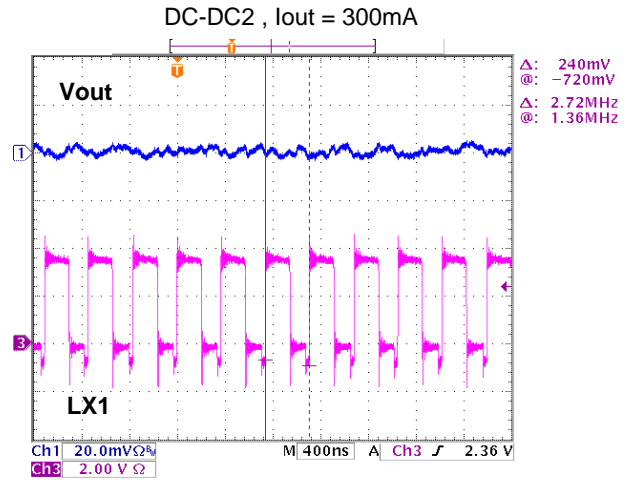
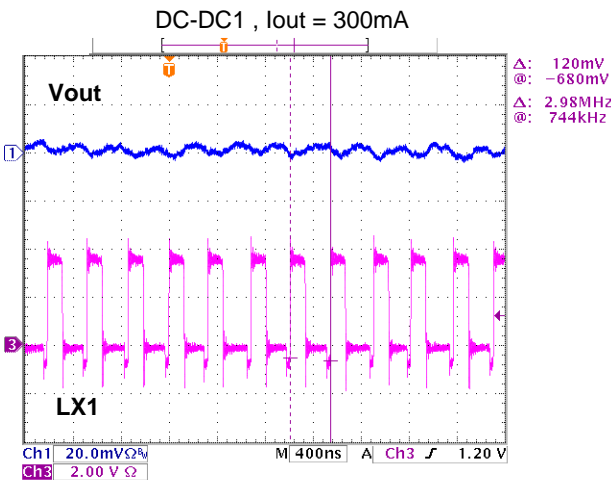
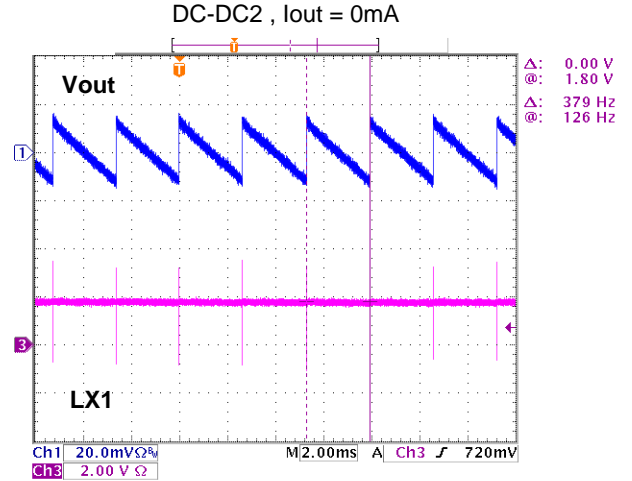
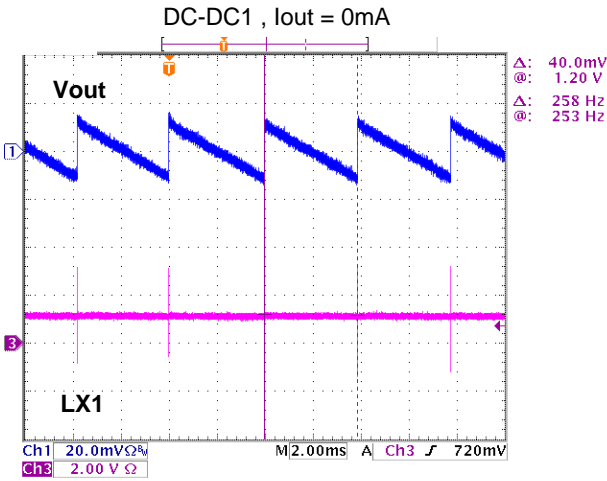

TYPICAL CHARACTERISTICS CURVES (Continued)

(12) Frequency of DC-DC1 and DC-DC2

$I_{OUT} = 300\text{mA}$ , DC-DC1\_Vout = 1.2 V, DC-DC2\_Vout=1.85V ,  $L_1 = L_2 = 1\ \mu\text{H}$   
 CDCDCOUT1 = CDCDCOUT2 = 4.7  $\mu\text{F}$

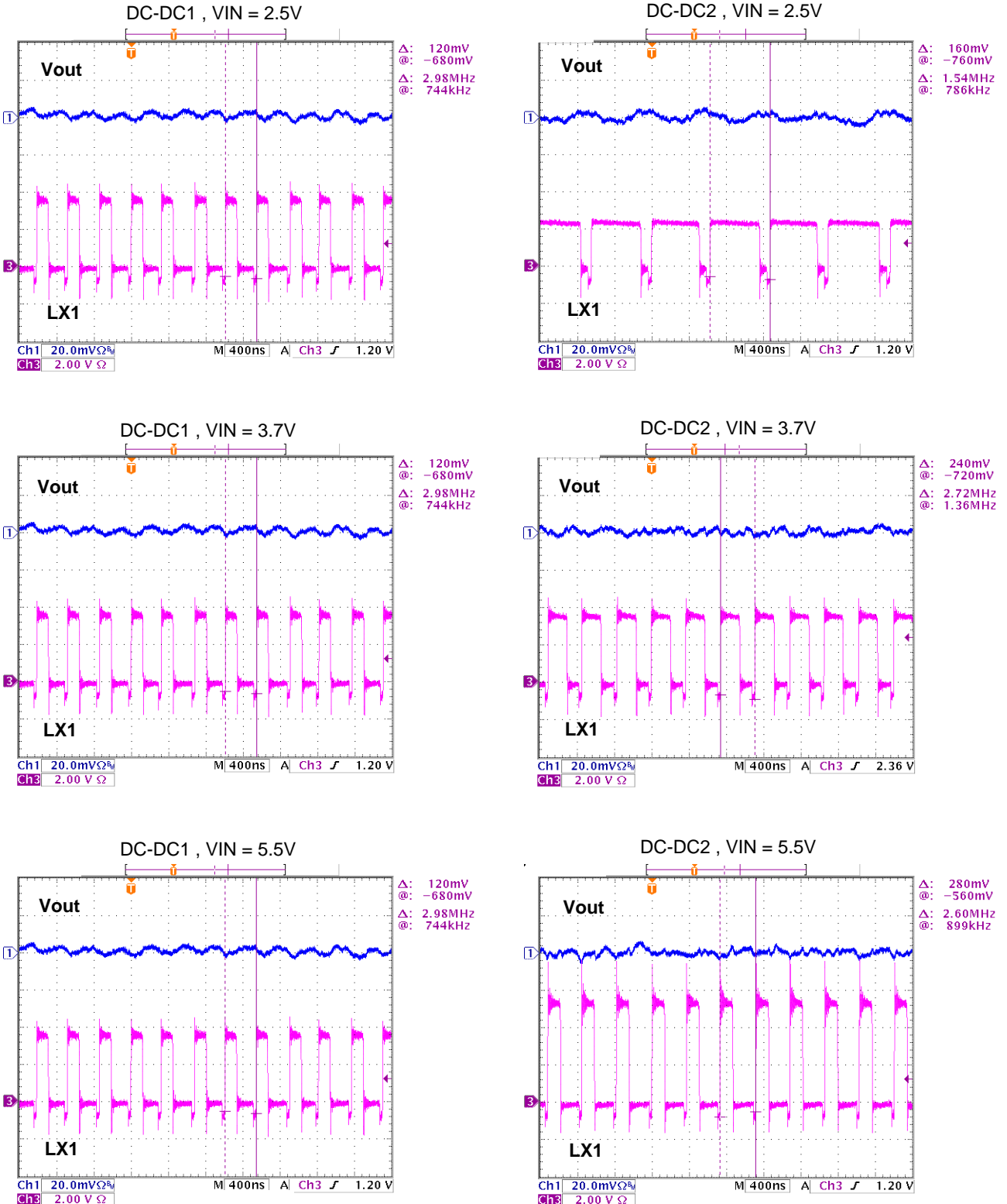



**OPERATION**

Note) The characteristics listed below are reference values derived from the design of the IC and are not guaranteed.

**1. I<sup>2</sup>C-bus Interface**

a.) Basic Rules

This IC, I<sup>2</sup>C-bus, is designed to correspond to the Standard-mode (100 kbps) and Fast-mode(400 kbps) devices in the version 2.1 of NXP's specification. However, it does not correspond to the HS-mode (to 3.4 Mbps). This IC will operate as a slave device in the I<sup>2</sup>C-bus system. This IC will not operate as a master device. The program operation check of this IC has not been conducted on the multi-master bus system and the mixed-speed bus system, yet. The connected confirmation of this IC to the CBUS receiver also has not been checked. Please confirm with our company if the IC will be used in these mode systems. The I<sup>2</sup>C is the brand of NXP.

b.) START and STOP conditions

A High to Low transition on the SDA line while SCL is High is one such unique case. This situation indicates START condition. A Low to High transition on the SDA line while SCL is High defines STOP condition. START and STOP conditions are always generated by the master. After START condition occur, the bus will be busy. The bus is considered to be free again a certain time after the STOP condition.

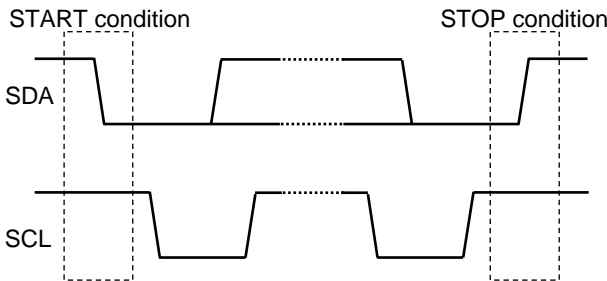

Every byte put on the SDA line must be 8-bits long. The number of bytes that can be transmitted per transfer is unrestricted. Each byte has to be followed by an acknowledgement bit. Data is transferred with the most significant bit (MSB) first.

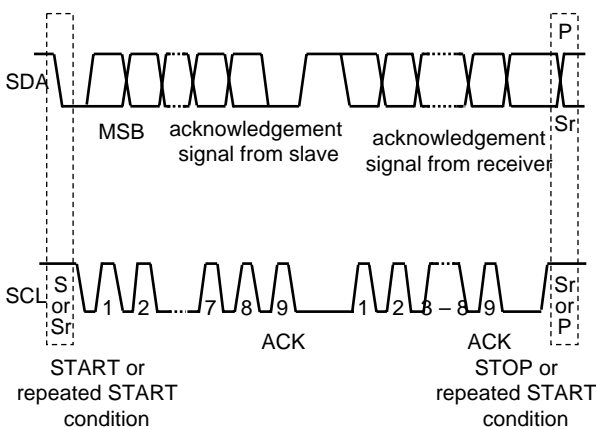

d.) Data format

Slave Address

Pin ASEL	A6	A5	A4	A3	A2	A1	A0	R/W	Hex
Low	1	1	1	0	0	1	0	x	72h
High	1	1	1	0	0	1	1	x	73h

Write mode

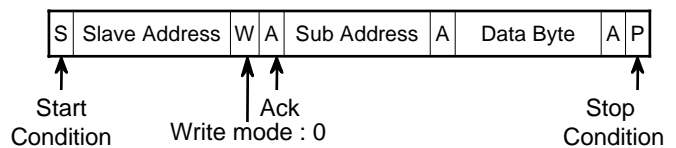

Read mode

d1.) When Sub address is not specified

When data is read without assigning sub-address, it is possible to read the value of sub-address specified in Write mode immediately before.

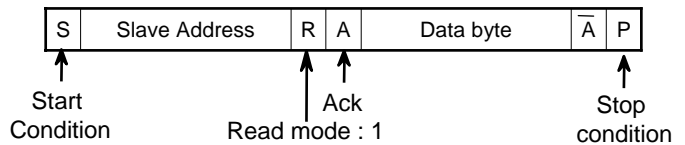

Ex) When writing data into address and reading data from "01 h".

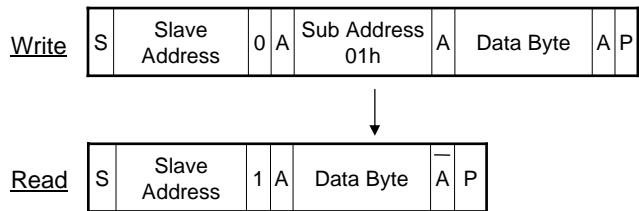

d2.) When Sub address is specified

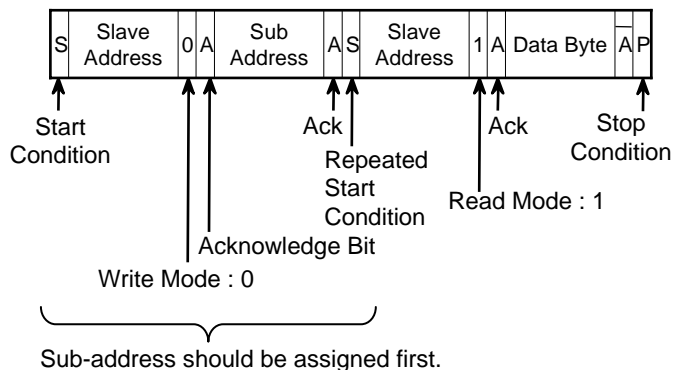

Sub-address should be assigned first.

**OPERATION ( Continued )**

Note) The characteristics listed below are reference values derived from the design of the IC and are not guaranteed.

**2. Register map**

Sub Address	R/W	Register Name	Bit	Data							
				D7	D6	D5	D4	D3	D2	D1	D0
00h	R/W	CNT	Name	LD6ON	LD5ON	LD4ON	LD3ON	LD2ON	LD1ON	DD2ON	DD1ON
			Default	0	0	0	0	0	0	0	0
01h	R/W	DAC1	Name	VDC2[3:0]				VDC1[3:0]			
			Default	1	1	1	0	1	0	0	0
02h	R/W	DAC2	Name	VL2[3:0]				VL1[3:0]			
			Default	0	0	0	0	1	0	0	1
03h	R/W	DAC3	Name	VL4[3:0]				VL3[3:0]			
			Default	1	1	0	0	1	0	1	0
04h	R/W	DAC4	Name	VL6[3:0]				VL5[3:0]			
			Default	1	1	1	1	1	0	0	0
05h	R/W	PSCNT	Name	—	—	LD6PS	LD5PS	LD4PS	LD3PS	LD2PS	LD1PS
			Default	—	—	0	0	0	0	0	0
06h	R/W	ENSEL	Name	—	—	—	—	—	—	—	LDO1EN SEL
			Default	—	—	—	—	—	—	—	1

Initial voltage	LDO6	LDO5	LDO4	LDO3	LDO2	LDO1	DCDC2	DCDC1
	3.3 V	1.8 V	2.8 V	2.6 V	1.0 V	1.85 V	1.85 V	1.2 V

**OPERATION ( Continued )**

Note) The characteristics listed below are reference values derived from the design of the IC and are not guaranteed.

**3. Register map details**

Sub Address	R/W	Register Name	Bit	Data							
				D7	D6	D5	D4	D3	D2	D1	D0
00h	R/W	CNT	Name	LD6ON	LD5ON	LD4ON	LD3ON	LD2ON	LD1ON	DD2ON	DD1ON
			Default	0	0	0	0	0	0	0	0

- D7 : LDO6 ON/OFF select register  
[0] : OFF (default)  
[1] : ON
- D6 : LDO5 ON/OFF select register  
[0] : OFF (default)  
[1] : ON
- D5 : LDO4 ON/OFF select register  
[0] : OFF (default)  
[1] : ON
- D4 : LDO3 ON/OFF select register  
[0] : OFF (default)  
[1] : ON
- D3 : LDO2 ON/OFF select register  
[0] : OFF (default)  
[1] : ON
- D2 : LDO1 ON/OFF select register  
[0] : OFF (default)  
[1] : ON
- D1 : DCDC2 ON/OFF select register  
[0] : OFF (default)  
[1] : ON
- D0 : DCDC1 ON/OFF select register  
[0] : OFF (default)  
[1] : ON

**OPERATION ( Continued )**

Note) The characteristics listed below are reference values derived from the design of the IC and are not guaranteed.

**3. Register map details**

Sub Address	R/W	Register Name	Bit	Data							
				D7	D6	D5	D4	D3	D2	D1	D0
01h	R/W	DAC1	Name	VDC2[3:0]				VDC1[3:0]			
			Default	1	1	1	0	1	0	0	0

D7-4 : DCDC2 Register for output voltage setup

VDC2[3:0]				Output voltage [V]
D7	D6	D5	D4	
0	0	0	0	0.80
0	0	0	1	0.85
0	0	1	0	0.90
0	0	1	1	0.95
0	1	0	0	1.00
0	1	0	1	1.05
0	1	1	0	1.10
0	1	1	1	1.15
1	0	0	0	1.20
1	0	0	1	1.30
1	0	1	0	1.40
1	0	1	1	1.50
1	1	0	0	1.65
1	1	0	1	1.80
1	1	1	0	1.85 (Default)
1	1	1	1	2.40

D3-0 : DCDC1 Register for output voltage setup

VDC1[3:0]				Output voltage [V]
D3	D2	D1	D0	
0	0	0	0	0.80
0	0	0	1	0.85
0	0	1	0	0.90
0	0	1	1	0.95
0	1	0	0	1.00
0	1	0	1	1.05
0	1	1	0	1.10
0	1	1	1	1.15
1	0	0	0	1.20 (Default)
1	0	0	1	1.30
1	0	1	0	1.40
1	0	1	1	1.50
1	1	0	0	1.65
1	1	0	1	1.80
1	1	1	0	1.85
1	1	1	1	2.40

**OPERATION ( Continued )**

Note) The characteristics listed below are reference values derived from the design of the IC and are not guaranteed.

**3. Register map details**

Sub Address	R/W	Register Name	Bit	Data							
				D7	D6	D5	D4	D3	D2	D1	D0
02h	R/W	DAC2	Name	VL2[3:0]				VL1[3:0]			
			Default	0	0	0	0	1	0	0	1

D7-4 : LDO2 Register for output voltage setup

VL2[3:0]				Output voltage [V]
D7	D6	D5	D4	
0	0	0	0	1.00 (Default)
0	0	0	1	1.10
0	0	1	0	1.20
0	0	1	1	1.30
0	1	0	0	1.40
0	1	0	1	1.50
0	1	1	0	1.60
0	1	1	1	1.70
1	0	0	0	1.80
1	0	0	1	1.85
1	0	1	0	2.60
1	0	1	1	2.70
1	1	0	0	2.80
1	1	0	1	2.85
1	1	1	0	3.00
1	1	1	1	3.30

D3-0 : LDO1 Register for output voltage setup

VL1[3:0]				Output voltage [V]
D3	D2	D1	D0	
0	0	0	0	1.00
0	0	0	1	1.10
0	0	1	0	1.20
0	0	1	1	1.30
0	1	0	0	1.40
0	1	0	1	1.50
0	1	1	0	1.60
0	1	1	1	1.70
1	0	0	0	1.80
1	0	0	1	1.85 (Default)
1	0	1	0	1.90
1	0	1	1	2.70
1	1	0	0	2.80
1	1	0	1	2.85
1	1	1	0	3.00
1	1	1	1	3.30

**OPERATION ( Continued )**

Note) The characteristics listed below are reference values derived from the design of the IC and are not guaranteed.

**3. Register map details**

Sub Address	R/W	Register Name	Bit	Data							
				D7	D6	D5	D4	D3	D2	D1	D0
03h	R/W	DAC3	Name	VL4[3:0]				VL3[3:0]			
			Default	1	1	0	0	1	0	1	0

D7-4 : LDO4 Register for output voltage setup

VL4[3:0]				Output voltage [V]
D7	D6	D5	D4	
0	0	0	0	1.00
0	0	0	1	1.10
0	0	1	0	1.20
0	0	1	1	1.30
0	1	0	0	1.40
0	1	0	1	1.50
0	1	1	0	1.60
0	1	1	1	1.70
1	0	0	0	1.80
1	0	0	1	1.85
1	0	1	0	2.60
1	0	1	1	2.70
1	1	0	0	2.80 (Default)
1	1	0	1	2.85
1	1	1	0	3.00
1	1	1	1	3.30

D3-0 : LDO3 Register for output voltage setup

VL3[3:0]				Output voltage [V]
D3	D2	D1	D0	
0	0	0	0	1.00
0	0	0	1	1.10
0	0	1	0	1.20
0	0	1	1	1.30
0	1	0	0	1.40
0	1	0	1	1.50
0	1	1	0	1.60
0	1	1	1	1.70
1	0	0	0	1.80
1	0	0	1	1.85
1	0	1	0	2.60 (Default)
1	0	1	1	2.70
1	1	0	0	2.80
1	1	0	1	2.85
1	1	1	0	3.00
1	1	1	1	3.30

**OPERATION ( Continued )**

Note) The characteristics listed below are reference values derived from the design of the IC and are not guaranteed.

**3. Register map details**

Sub Address	R/W	Register Name	Bit	Data							
				D7	D6	D5	D4	D3	D2	D1	D0
04h	R/W	DAC4	Name	VL6[3:0]				VL5[3:0]			
			Default	1	1	1	1	1	0	0	0

D7-4 : LDO6 Register for output voltage setup

VL6[3:0]				Output voltage [V]
D7	D6	D5	D4	
0	0	0	0	1.00
0	0	0	1	1.10
0	0	1	0	1.20
0	0	1	1	1.30
0	1	0	0	1.40
0	1	0	1	1.50
0	1	1	0	1.60
0	1	1	1	1.70
1	0	0	0	1.80
1	0	0	1	1.85
1	0	1	0	2.60
1	0	1	1	2.70
1	1	0	0	2.80
1	1	0	1	2.85
1	1	1	0	3.00
1	1	1	1	3.30 (Default)

D3-0 : LDO5 Register for output voltage setup

VL5[3:0]				Output voltage [V]
D3	D2	D1	D0	
0	0	0	0	1.00
0	0	0	1	1.10
0	0	1	0	1.20
0	0	1	1	1.30
0	1	0	0	1.40
0	1	0	1	1.50
0	1	1	0	1.60
0	1	1	1	1.70
1	0	0	0	1.80 (Default)
1	0	0	1	1.85
1	0	1	0	2.60
1	0	1	1	2.70
1	1	0	0	2.80
1	1	0	1	2.85
1	1	1	0	3.00
1	1	1	1	3.30

**OPERATION ( Continued )**

Note) The characteristics listed below are reference values derived from the design of the IC and are not guaranteed.

**3. Register map details**

Sub Address	R/W	Register Name	Bit	Data							
				D7	D6	D5	D4	D3	D2	D1	D0
05h	R/W	PSCNT	Name	—	—	LD6PS	LD5PS	LD4PS	LD3PS	LD2PS	LD1PS
			Default	—	—	0	0	0	0	0	0

\* Please set it to normal mode when LDO starts.

D5 : LDO6 Power save mode select register  
 [0] : Normal mode (default)  
 [1] : Power save mode

D4 : LDO5 Power save mode select register  
 [0] : Normal mode (default)  
 [1] : Power save mode

D3 : LDO4 Power save mode select register  
 [0] : Normal mode (default)  
 [1] : Power save mode

D2 : LDO3 Power save mode select register  
 [0] : Normal mode (default)  
 [1] : Power save mode

D1 : LDO2 Power save mode select register  
 [0] : Normal mode (default)  
 [1] : Power save mode

D0 : LDO1 Power save mode select register  
 [0] : Normal mode (default)  
 [1] : Power save mode



**OPERATION ( Continued )**

Note) The characteristics listed below are reference values derived from the design of the IC and are not guaranteed.

**3. Register map details**

Sub Address	R/W	Register Name	Bit	Data								
				D7	D6	D5	D4	D3	D2	D1	D0	
06h	R/W	ENSEL	Name	—	—	—	—	—	—	—	—	LDO1EN SEL
			Default	—	—	—	—	—	—	—	—	1

D0 : LDO1ENSEL

[0] : LDO1ON control invalid

[1] : LDO1ON control valid (default)

OPERATION ( Continued )

Note) The characteristics listed below are reference values derived from the design of the IC and are not guaranteed.

4. Timing Chart (Sequence – 1 (DVDD input externally))

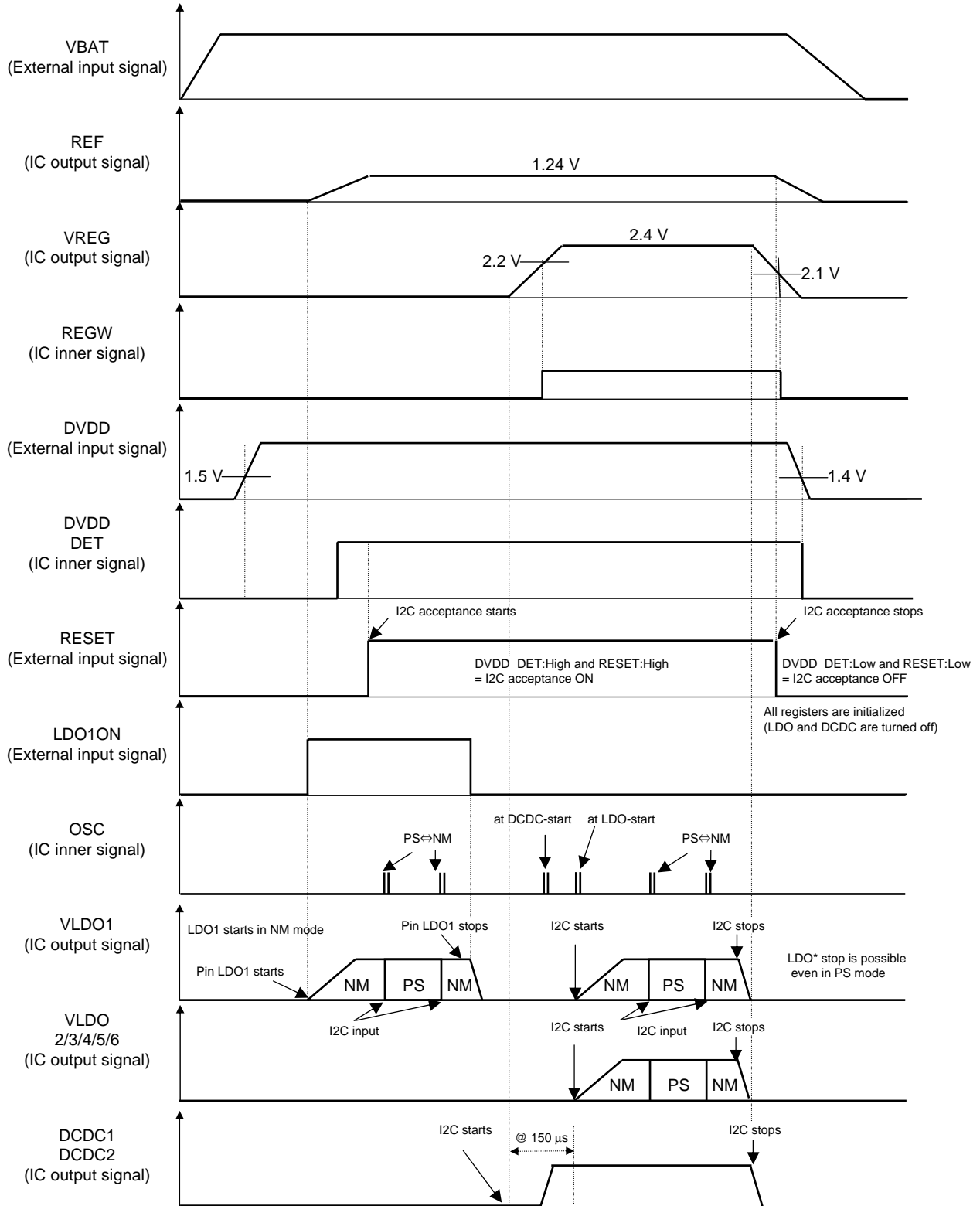

OPERATION ( Continued )

Note) The characteristics listed below are reference values derived from the design of the IC and are not guaranteed.

4. Timing Chart (Sequence – 2 (LDO1ON = fixed VBAT))

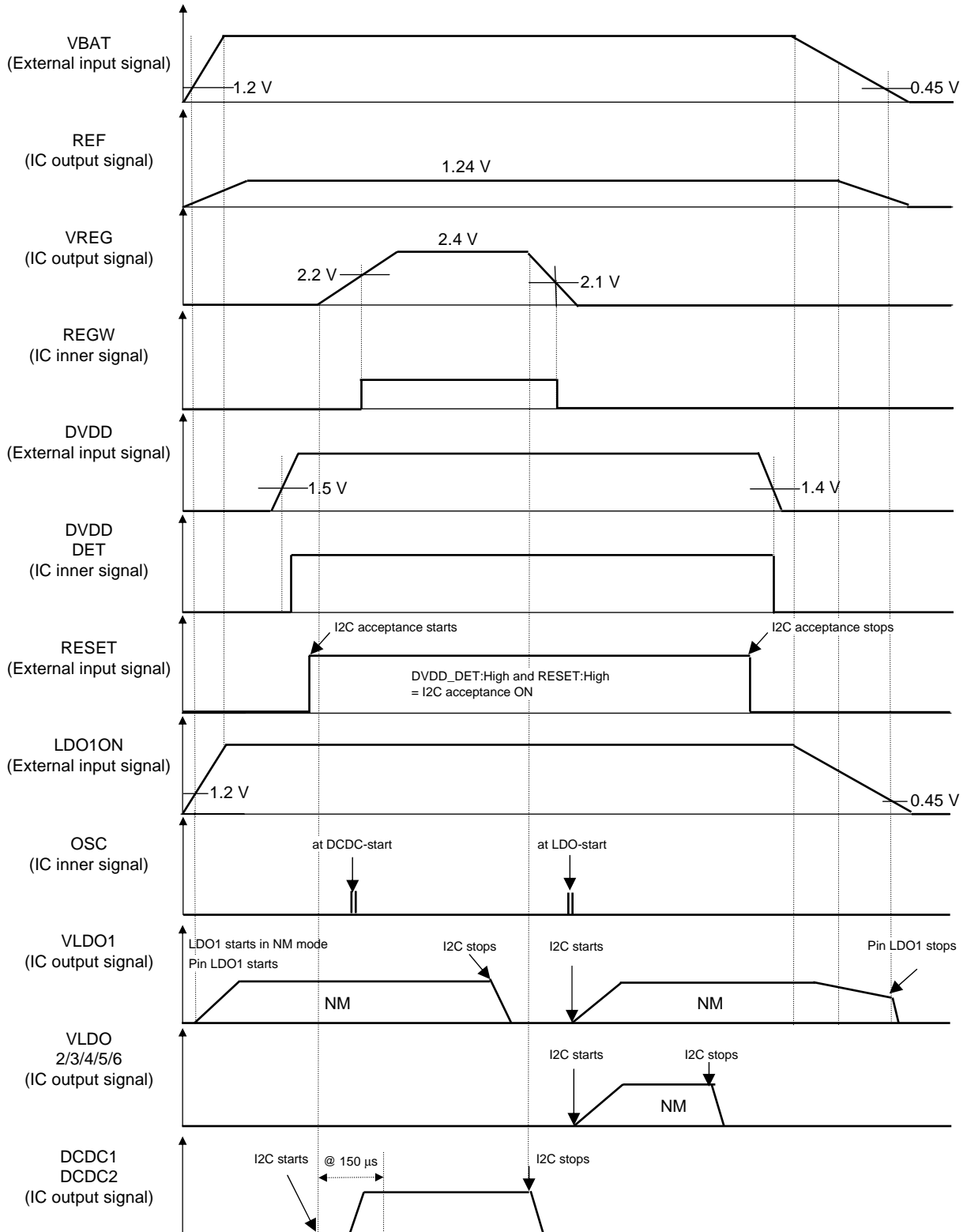

OPERATION ( Continued )

Note) The characteristics listed below are reference values derived from the design of the IC and are not guaranteed.

4. Timing Chart (Sequence – 3 (VLDO1 = connected DVDD))

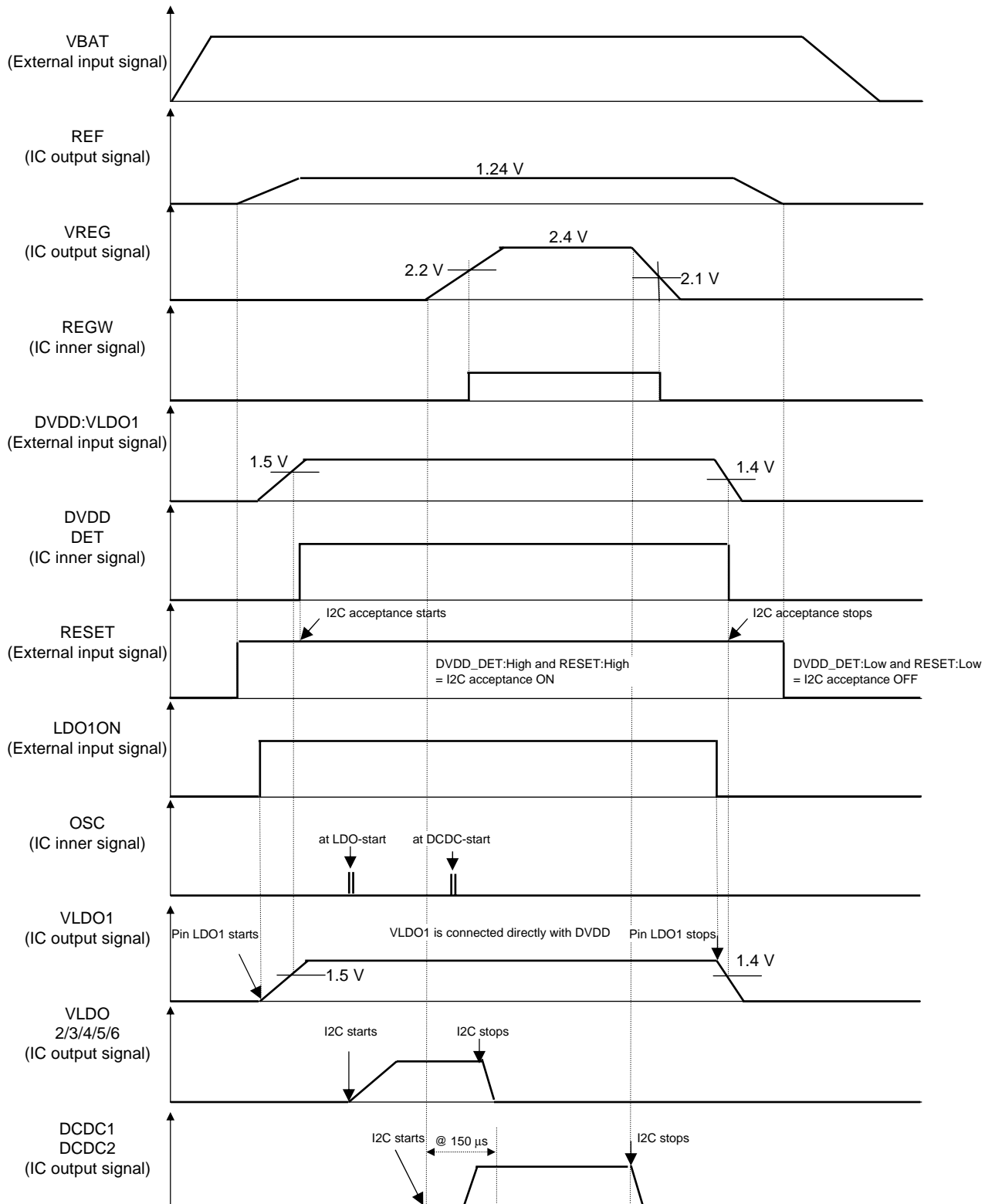

**OPERATION ( Continued )**

Note) The characteristics listed below are reference values derived from the design of the IC and are not guaranteed.

**5. DC-DC Protection Operation**

< Operation explanation >

- (1) The Overcurrent protection operates at about 1 A (Typ).
- (2) The Ground protection sequence is implemented when the output voltage decreases to about 70% of the set voltage.
- (3) The Ground short protection operates intermittently. (2 ms : ON, 16 ms : OFF)

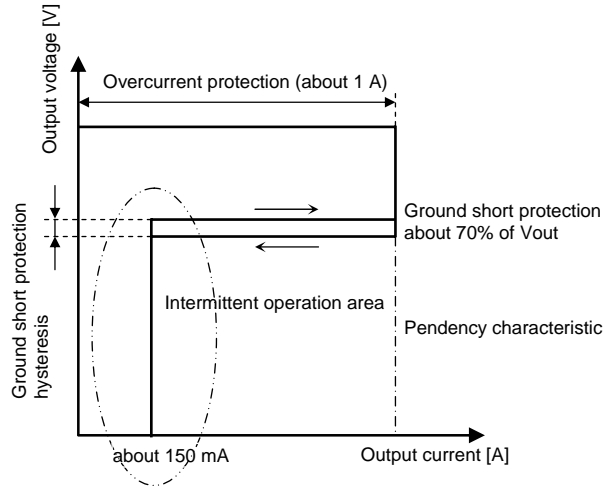

Operation explanation chart

**6. DAC Voltage Accuracy**

DCDC1 (VBAT = 3.7 V , Iout = 300 mA)

VDC1[3:0]				Output voltage [V]	Accuracy [%]
D3	D2	D1	D0		
0	0	0	0	0.80	±5.0
0	0	0	1	0.85	±5.0
0	0	1	0	0.90	±4.5
0	0	1	1	0.95	±4.0
0	1	0	0	1.00	±4.0
0	1	0	1	1.05	±4.0
0	1	1	0	1.10	±3.5
0	1	1	1	1.15	±3.5
1	0	0	0	1.20 (Default)	±2.5
1	0	0	1	1.30	±3.0
1	0	1	0	1.40	±3.0
1	0	1	1	1.50	±3.0
1	1	0	0	1.65	±3.0
1	1	0	1	1.80	±3.0
1	1	1	0	1.85	±3.0
1	1	1	1	2.40	±3.0

DCDC2 (VBAT = 3.7 V , Iout = 300 mA)

VDC2[3:0]				Output voltage [V]	Accuracy [%]
D3	D2	D1	D0		
0	0	0	0	0.80	±8.5
0	0	0	1	0.85	±6.5
0	0	1	0	0.90	±6.5
0	0	1	1	0.95	±6.0
0	1	0	0	1.00	±6.0
0	1	0	1	1.05	±6.0
0	1	1	0	1.10	±5.5
0	1	1	1	1.15	±5.5
1	0	0	0	1.20	±3.0
1	0	0	1	1.30	±3.0
1	0	1	0	1.40	±4.0
1	0	1	1	1.50	±3.0
1	1	0	0	1.65	±3.0
1	1	0	1	1.80	±4.0
1	1	1	0	1.85 (Default)	±2.5
1	1	1	1	2.40	±3.0

**OPERATION ( Continued )**

Note) The characteristics listed below are reference values derived from the design of the IC and are not guaranteed.

**6. DAC Voltage Accuracy (continued)**

LDO VBAT = 3.7 V (Normal-mode : Iout = 150 mA, PS-mode : Iout = 5 mA)

VL1[3:0]				Output voltage [V]	Accuracy [%]			
D3	D2	D1	D0		Normal-mode		PS-mode	
					LDO1	LDO2 to 6	LDO1	LDO2 to 6
0	0	0	0	1.00	±5.0	±5.0	±5.0	±5.0
0	0	0	1	1.10	±4.5	±4.5	±4.5	±4.5
0	0	1	0	1.20	±4.0	±4.0	±4.0	±4.0
0	0	1	1	1.30	±4.0	±4.0	±4.0	±4.0
0	1	0	0	1.40	±3.0	±3.0	±3.0	±3.0
0	1	0	1	1.50	±3.0	±3.0	±3.0	±3.0
0	1	1	0	1.60	±3.0	±3.0	±3.0	±3.0
0	1	1	1	1.70	±3.0	±3.0	±3.0	±3.0
1	0	0	0	1.80	±3.0	±3.0	±3.0	±3.0
1	0	0	1	1.85	±2.5	±2.5	±2.5	±2.5
1	0	1	0	1.90	±2.5	—	±2.5	—
				2.60	—	±3.0	—	±3.0
1	0	1	1	2.70	±3.0	±3.0	±3.0	±3.0
1	1	0	0	2.80	±3.0	±3.0	±3.0	±3.0
1	1	0	1	2.85	±3.0	±3.0	±3.0	±3.0
1	1	1	0	3.00	±3.0	±3.0	±3.0	±3.0
1	1	1	1	3.30	±3.0	±3.0	±3.0	±3.0

APPLICATION INFORMATION

Note) The characteristics listed below are reference values derived from the design of the IC and are not guaranteed.

1.Application Circuit and Evaluation Board

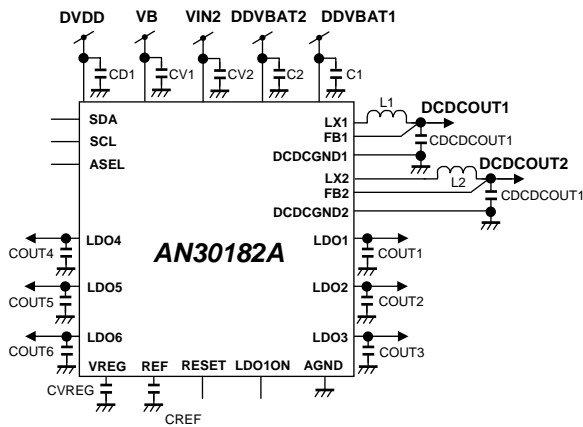

Figure : Application Circuit

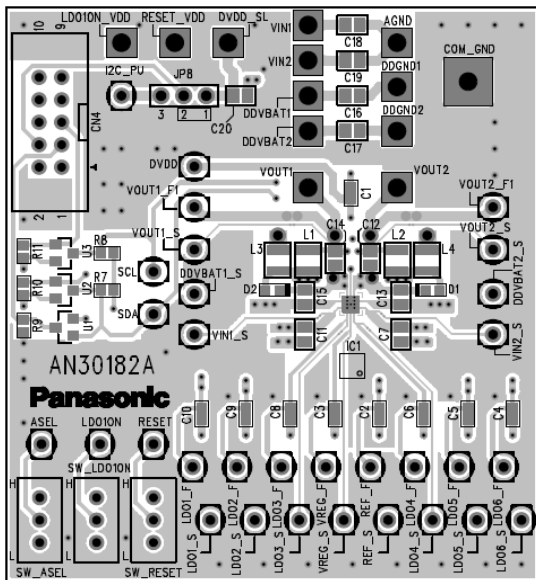

Figure : Top Layer with silk screen ( Top View ) with Evaluation Board

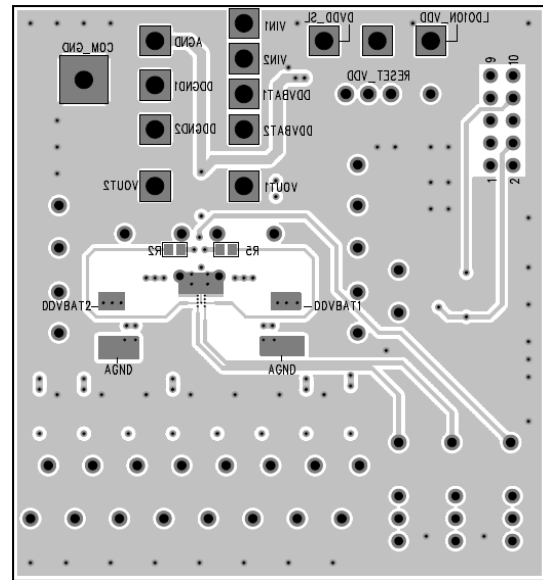

Figure : Bottom Layer with silk screen ( Bottom View ) with Evaluation Board

Notes) This application circuit and layout is an example. The operation of mass production set is not guaranteed. You should perform enough evaluation and verification on the design of mass production set. You are fully responsible for the incorporation of the above application circuit and information in the design of your equipment.

**APPLICATION INFORMATION( Continued )**

Note) The characteristics listed below are reference values derived from the design of the IC and are not guaranteed.

**2.RECOMMENDED COMPONENT**

Reference Designator	QTY	Value	Manufacturer	Part Number
C1	1	4.7 $\mu$ F	Murata	GRM21BB31C475KA87
C2	1	4.7 $\mu$ F	Murata	GRM21BB31C475KA87
CV1	1	4.7 $\mu$ F	Murata	GRM21BB31C475KA87
VC2	1	4.7 $\mu$ F	Murata	GRM21BB31C475KA87
CD1	1	0.1 $\mu$ F	Murata	GRM188B11C104KA01
L1	1	1.0 $\mu$ H	FDK	MIPSZ2012D1R0
CDCDCOUT1	1	4.7 $\mu$ F	Murata	GRM21BB31A475KA74
L2	1	1.0 $\mu$ H	FDK	MIPSZ2012D1R0
CDCDCOUT2	1	4.7 $\mu$ F	Murata	GRM21BB31A475KA74
COUT1	1	1.0 $\mu$ F	Murata	GRM185B31A105KE35
COUT2	1	1.0 $\mu$ F	Murata	GRM185B31A105KE35
COUT3	1	1.0 $\mu$ F	Murata	GRM185B31A105KE35
COUT4	1	1.0 $\mu$ F	Murata	GRM185B31A105KE35
COUT5	1	1.0 $\mu$ F	Murata	GRM185B31A105KE35
COUT6	1	1.0 $\mu$ F	Murata	GRM185B31A105KE35
CVREG	1	1.0 $\mu$ F	Murata	GRM185B31A105KE35
CREF	1	1.0 $\mu$ F	Murata	GRM185B31A105KE35

Figure : Recommended Component



**PACKAGE INFORMATION ( Reference Data )**

Outline Drawing

Package Code : XBGA025-W-2222AEL

Unit:mm

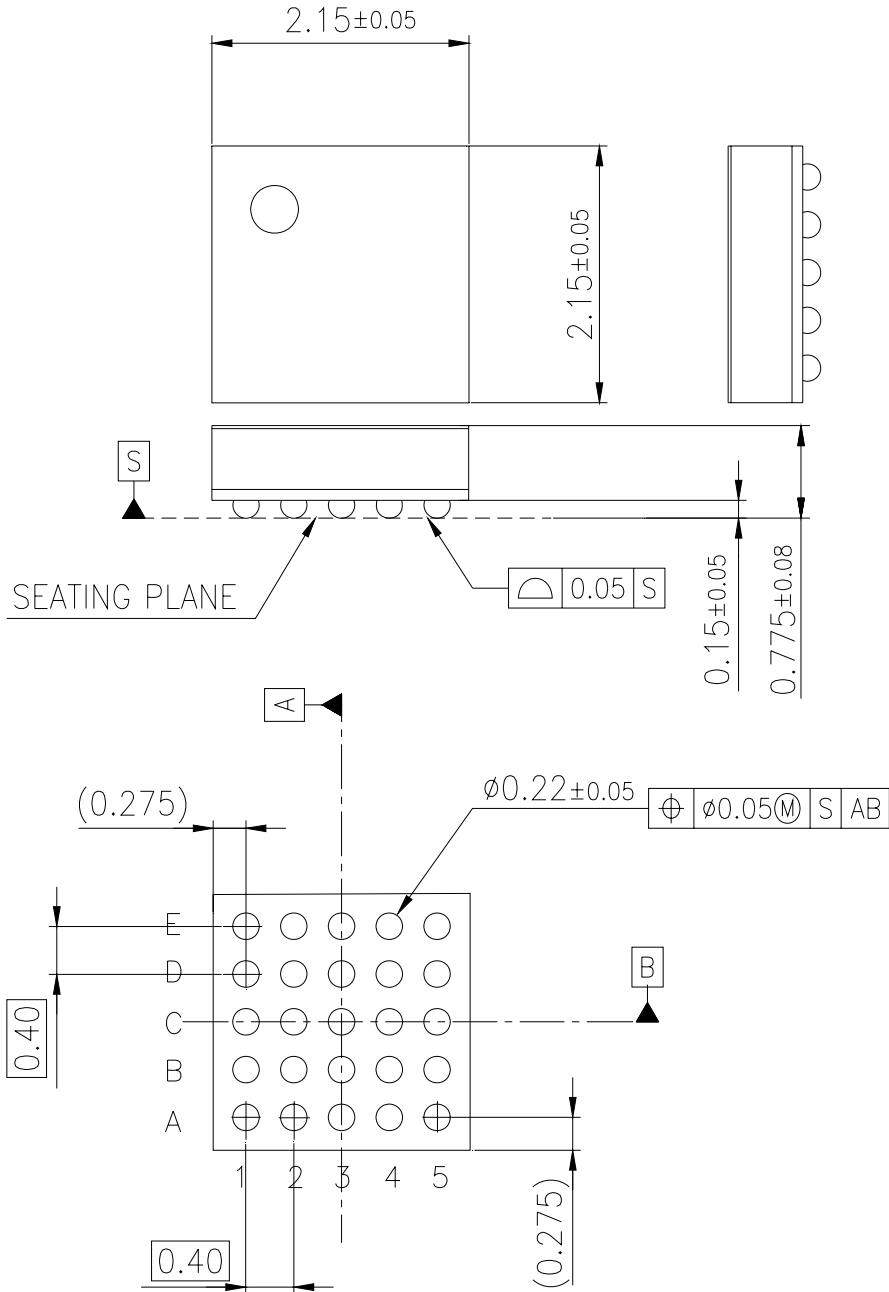

Body Material	: Br/Sb Free Epoxy resin
Reroute Material	: Cu
Bump	: SnAgCu

**IMPORTANT NOTICE**

1. The products and product specifications described in this book are subject to change without notice for modification and/or improvement. At the final stage of your design, purchasing, or use of the products, therefore, ask for the most up-to-date Product Standards in advance to make sure that the latest specifications satisfy your requirements.
  
2. When using the LSI for new models, verify the safety including the long-term reliability for each product.
  
3. When the application system is designed by using this LSI, be sure to confirm notes in this book.  
Be sure to read the notes to descriptions and the usage notes in the book.
  
4. The technical information described in this book is intended only to show the main characteristics and application circuit examples of the products. No license is granted in and to any intellectual property right or other right owned by Panasonic Corporation or any other company. Therefore, no responsibility is assumed by our company as to the infringement upon any such right owned by any other company which may arise as a result of the use of technical information de-scribed in this book.
  
5. This book may be not reprinted or reproduced whether wholly or partially, without the prior written permission of our company.
  
6. This LSI is intended to be used for general electronic equipment.  
Consult our sales staff in advance for information on the following applications: Special applications in which exceptional quality and reliability are required, or if the failure or malfunction of this LSI may directly jeopardize life or harm the human body.  
Any applications other than the standard applications intended.  
  - (1) Space appliance (such as artificial satellite, and rocket)
  - (2) Traffic control equipment (such as for automobile, airplane, train, and ship)
  - (3) Medical equipment for life support
  - (4) Submarine transponder
  - (5) Control equipment for power plant
  - (6) Disaster prevention and security device
  - (7) Weapon
  - (8) Others : Applications of which reliability equivalent to (1) to (7) is required
 It is to be understood that our company shall not be held responsible for any damage incurred as a result of or in connection with your using the LSI described in this book for any special application, unless our company agrees to your using the LSI in this book for any special application.
  
7. This LSI is neither designed nor intended for use in automotive applications or environments unless the specific product is designated by our company as compliant with the ISO/TS 16949 requirements.  
Our company shall not be held responsible for any damage incurred by you or any third party as a result of or in connection with your using the LSI in automotive application, unless our company agrees to your using the LSI in this book for such application.
  
8. If any of the products or technical information described in this book is to be exported or provided to non-residents, the laws and regulations of the exporting country, especially, those with regard to security export control, must be observed.
  
9. Please use this product in compliance with all applicable laws and regulations that regulate the inclusion or use of controlled substances, including without limitation, the EU RoHS Directive.  
Our company shall not be held responsible for any damage incurred as a result of your using the LSI not complying with the applicable laws and regulations.

---

**USAGE NOTES**

1. When designing your equipment, comply with the range of absolute maximum rating and the guaranteed operating conditions (operating power supply voltage and operating environment etc.). Especially, please be careful not to exceed the range of absolute maximum rating on the transient state, such as power-on, power-off and mode-switching. Otherwise, we will not be liable for any defect which may arise later in your equipment.

Even when the products are used within the guaranteed values, take into the consideration of incidence of break down and failure mode, possible to occur to semiconductor products. Measures on the systems such as redundant design, arresting the spread of fire or preventing glitch are recommended in order to prevent physical injury, fire, social damages, for example, by using the products.

2. Comply with the instructions for use in order to prevent breakdown and characteristics change due to external factors (ESD, EOS, thermal stress and mechanical stress) at the time of handling, mounting or at customer's process. When using products for which damp-proof packing is required, satisfy the conditions, such as shelf life and the elapsed time since first opening the packages.
3. Pay attention to the direction of LSI. When mounting it in the wrong direction onto the PCB (printed-circuit-board), it might smoke or ignite.
4. Pay attention in the PCB (printed-circuit-board) pattern layout in order to prevent damage due to short circuit between pins. In addition, refer to the Pin Description for the pin configuration.
5. Perform a visual inspection on the PCB before applying power, otherwise damage might happen due to problems such as a solder-bridge between the pins of the semiconductor device. Also, perform a full technical verification on the assembly quality, because the same damage possibly can happen due to conductive substances, such as solder ball, that adhere to the LSI during transportation.
6. Take notice in the use of this product that it might break or occasionally smoke when an abnormal state occurs such as output pin-VCC short (Power supply fault), output pin-GND short (Ground fault), or output-to-output-pin short (load short) .

And, safety measures such as an installation of fuses are recommended because the extent of the above-mentioned damage and smoke emission will depend on the current capability of the power supply.

7. The protection circuit is for maintaining safety against abnormal operation. Therefore, the protection circuit should not work during normal operation.  
  
Especially for the thermal protection circuit, if the area of safe operation or the absolute maximum rating is momentarily exceeded due to output pin to VCC short (Power supply fault), or output pin to GND short (Ground fault), the LSI might be damaged before the thermal protection circuit could operate.
8. Unless specified in the product specifications, make sure that negative voltage or excessive voltage are not applied to the pins because the device might be damaged, which could happen due to negative voltage or excessive voltage generated during the ON and OFF timing when the inductive load of a motor coil or actuator coils of optical pick-up is being driven.
9. The product which has specified ASO (Area of Safe Operation) should be operated in ASO
10. Verify the risks which might be caused by the malfunctions of external components.
11. Connect the metallic plates on the back side of the LSI with their respective potentials (AGND, PVIN, LX). The thermal resistance and the electrical characteristics are guaranteed only when the metallic plates are connected with their respective potentials.

## Request for your special attention and precautions in using the technical information and semiconductors described in this book

- (1) If any of the products or technical information described in this book is to be exported or provided to non-residents, the laws and regulations of the exporting country, especially, those with regard to security export control, must be observed.
- (2) The technical information described in this book is intended only to show the main characteristics and application circuit examples of the products. No license is granted in and to any intellectual property right or other right owned by Panasonic Corporation or any other company. Therefore, no responsibility is assumed by our company as to the infringement upon any such right owned by any other company which may arise as a result of the use of technical information described in this book.
- (3) The products described in this book are intended to be used for general applications (such as office equipment, communications equipment, measuring instruments and household appliances), or for specific applications as expressly stated in this book.  
Consult our sales staff in advance for information on the following applications:
  - Special applications (such as for airplanes, aerospace, automotive equipment, traffic signaling equipment, combustion equipment, life support systems and safety devices) in which exceptional quality and reliability are required, or if the failure or malfunction of the products may directly jeopardize life or harm the human body.It is to be understood that our company shall not be held responsible for any damage incurred as a result of or in connection with your using the products described in this book for any special application, unless our company agrees to your using the products in this book for any special application.
- (4) The products and product specifications described in this book are subject to change without notice for modification and/or improvement. At the final stage of your design, purchasing, or use of the products, therefore, ask for the most up-to-date Product Standards in advance to make sure that the latest specifications satisfy your requirements.
- (5) When designing your equipment, comply with the range of absolute maximum rating and the guaranteed operating conditions (operating power supply voltage and operating environment etc.). Especially, please be careful not to exceed the range of absolute maximum rating on the transient state, such as power-on, power-off and mode-switching. Otherwise, we will not be liable for any defect which may arise later in your equipment.  
Even when the products are used within the guaranteed values, take into the consideration of incidence of break down and failure mode, possible to occur to semiconductor products. Measures on the systems such as redundant design, arresting the spread of fire or preventing glitch are recommended in order to prevent physical injury, fire, social damages, for example, by using the products.
- (6) Comply with the instructions for use in order to prevent breakdown and characteristics change due to external factors (ESD, EOS, thermal stress and mechanical stress) at the time of handling, mounting or at customer's process. When using products for which damp-proof packing is required, satisfy the conditions, such as shelf life and the elapsed time since first opening the packages.
- (7) This book may be not reprinted or reproduced whether wholly or partially, without the prior written permission of our company.