

# Q6 series

Ø6 mm panel mount LED indicators



## DISTINCTIVE FEATURES

3 mm colored diffused epoxy lens or 3 mm water clear super bright LEDs

Prominent, recessed and flush bezel styles

(2.0 x 0.5) solder lug terminals, pins or (200 mm long) wire terminations, other lengths available on request



## ENVIRONMENTAL SPECIFICATIONS

- IP67 sealing option (EN60529)
- Operating & Storage Temperature Range:  
Rear plastic body: -30 °C to +65 °C (-22 °F to +149 °F)  
Rear epoxy body: -40 °C to +85 °C (-40 °F to +185 °F)



## GENERAL SPECIFICATIONS

- Max Reverse Voltage: 5 V
- Viewing Angle: 30–100° (dependant on model)
- Life Expectancy: 100,000 hours
- Torque: 4 cNm (dependent on option)
- Maximum panel thickness 7 mm



## MATERIALS

- Plated brass bezel finished in bright chrome, black chrome or satin grey and moulded polycarbonate rear body



## MOUNTING

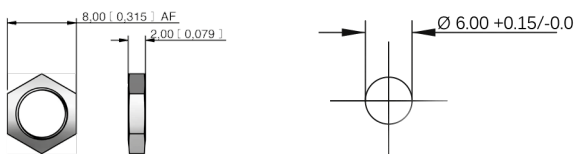

The company reserves the right to change specifications without notice.

All LED characteristics are dependent upon environmental conditions. Therefore published data should be considered nominal and subject to variations.



# Q6 series

Ø6 mm panel mount LED indicators



## ELECTRICAL SPECIFICATIONS

### STANDARD LED INTENSITY

LED COMPONENT SPECIFICATIONS			
	Prominent and Recessed	Flush	Forward Voltage
HE Red	40 mcd	10 mcd	2.0 V
Green	50 mcd	12 mcd	2.2 V
Yellow	30 mcd	6 mcd	2.1 V
Blue	1,200 mcd	100 mcd	3.8 V
White	1,200 mcd	160 mcd	3.8 V
Orange	60 mcd	10 mcd	2.0 V
Bi-color (Typical) (Red/Green)	20/15 mcd	10/8 mcd	2.0 V/2.2 V

Bi-color - The color is changed by reversing the polarity of the supply voltage.

### SUPER BRIGHT LED INTENSITY

LED COMPONENT SPECIFICATIONS			
	Prominent and Recessed	Flush	Forward Voltage
HE Red	1,000 mcd	700 mcd	2.2 V
Green	1,200 mcd	2,000 mcd	3.5 V
Yellow	2,000 mcd	8,000 mcd	2.3 V
Blue	1,600 mcd	200 mcd	3.3 V
White	1,200 mcd	350 mcd	3.3 V
Orange	10,000 mcd	500 mcd	2.2 V

### HYPER BRIGHT LED INTENSITY

LED COMPONENT SPECIFICATIONS			
	Prominent and Recessed	Flush	Forward Voltage
HE Red	3,700 mcd	600 mcd	2.2 V
Green	2,000 mcd	350 mcd	3.2 V
Yellow	1,200 mcd	140 mcd	2.0 V
Orange	4,500 mcd	400 mcd	2.2 V

- The operating voltage must not be exceeded by more than 10% as this will result in reduced life expectancy
- Luminous intensity is measured at 20 mA on a discrete LED unless otherwise stated.
- Luminous intensities and color shades of white LEDs may vary within a batch.
- Luminous intensity will be reduced with lower operating current.

Voltage	Operating Voltage	Operating Current
	(Min to Max)	(Typical All Types)
02 (No Resistor)	1.8 to 3.3 VDC	20 mA max*
6 VDC	5.4 to 6.6 VDC	20 mA
12 VDC	10.8 to 13.2 VDC	20 mA
24 VDC	21.6 to 26.4 VDC	20 mA
28 VDC	25.2 to 30.8 VDC	20 mA

\* Customer to supply resistor for desired operating current.



### BUILD YOUR PART NUMBER

<div style="border: 1px solid black; padding: 2px; width: 30px; margin: 0 auto;">Q</div> <p>SERIES</p>	<div style="border: 1px solid black; padding: 2px; width: 30px; margin: 0 auto;">6</div> <p>MOUNTING HOLE</p> <p>Ø6 mm</p>	<div style="border: 1px solid black; padding: 2px; width: 30px; margin: 0 auto;">P</div> <p>BEZEL STYLE</p> <ul style="list-style-type: none"> <li><b>P</b> Prominent</li> <li><b>R</b> Recessed</li> <li><b>F</b> Flush</li> </ul>	<div style="border: 1px solid black; padding: 2px; width: 30px; margin: 0 auto;">1</div> <p>TERMINALS</p> <ul style="list-style-type: none"> <li><b>1</b> Solder Lug/ Fastons (2.0 x 0.5)</li> <li><b>2</b> Pins</li> <li><b>3</b> Wires</li> </ul>	<div style="border: 1px solid black; padding: 2px; width: 30px; margin: 0 auto;">4</div> <p>BEZEL FINISH</p> <ul style="list-style-type: none"> <li><b>C</b> Bright Chrome</li> <li><b>B</b> Black Chrome</li> <li><b>G</b> Satin Grey</li> </ul>
<div style="border: 1px solid black; padding: 2px; width: 30px; margin: 0 auto;">XX</div> <p>TYPE OF ILLUMINATION</p> <ul style="list-style-type: none"> <li><b>XX</b> Fixed Light</li> <li><b>KK</b> Flashing Light (12 V – 28 VDC)</li> <li><b>YY</b> Bi-color</li> </ul>	<div style="border: 1px solid black; padding: 2px; width: 30px; margin: 0 auto;">R</div> <p>LED COLOR</p> <ul style="list-style-type: none"> <li><b>R</b> Red</li> <li><b>G</b> Green</li> <li><b>Y</b> Yellow</li> <li><b>B</b> Blue</li> <li><b>W</b> White</li> <li><b>O</b> Orange</li> <li><b>HR</b> Hyper Bright Red</li> <li><b>HG</b> Hyper Bright Green</li> <li><b>HY</b> Hyper Bright Yellow</li> <li><b>HO</b> Hyper Bright Orange</li> </ul>	<div style="border: 1px solid black; padding: 2px; width: 30px; margin: 0 auto;">SR</div> <p>VOLTAGE</p> <ul style="list-style-type: none"> <li><b>SR</b> Super Bright Red</li> <li><b>SG</b> Super Bright Green</li> <li><b>SY</b> Super Bright Yellow</li> <li><b>SB</b> Super Bright Blue</li> <li><b>SW</b> Super Bright White</li> <li><b>SO</b> Super Bright Orange</li> <li><b>RG</b> Red/Green</li> <li><b>RY</b> Red/Yellow</li> <li><b>GY</b> Green/Yellow</li> </ul>	<div style="border: 1px solid black; padding: 2px; width: 30px; margin: 0 auto;">02</div> <p>SEALING</p> <ul style="list-style-type: none"> <li><b>02</b> no resistor*</li> <li><b>06</b> 6V DC</li> <li><b>12</b> 12 VDC</li> <li><b>12A</b> 12 VAC/DC</li> <li><b>24</b> 24 VDC</li> <li><b>24A</b> 24 VAC/DC</li> <li><b>28</b> 28 VDC</li> <li><b>28A</b> 28 VAC/DC</li> </ul> <p>* please refer to the forward voltage in electrical specifications</p>	<div style="border: 1px solid black; padding: 2px; width: 30px; margin: 0 auto;">(Blank)</div> <p>SEALING</p> <ul style="list-style-type: none"> <li><b>(Blank)</b> Unsealed</li> <li><b>E</b> IP67</li> </ul>



### ABOUT THIS SERIES

- Notice:** please note that not all combinations of above numbers are available.
- Gold faston terminal denotes anode (+), silver terminal denotes cathode (-)
  - Standard wire length is 200 mm, 24 AWG UL1061, red wire denotes anode (+), black wire denotes cathode (-) for other wire lengths consult APEM.
  - For LEDs with alternative voltages consult APEM
  - Bi-color leds, by connecting the gold solder lug (+) one color is produced, by reversing the supply voltage another color is produced – bi-colors are available up to 28 V in DC only.
  - Take care when soldering to the faston terminals (recommended solder temperature 300 °C - 3 sec)
  - Short body options are only available up to 24 VDC.

# Q6 series

Ø6 mm panel mount LED indicators

## PROMINENT BEZEL



## WIRES

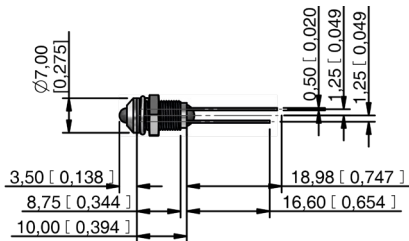

## REAR EPOXY WIRES

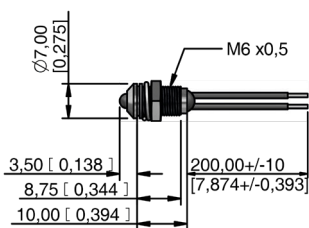

## SHORT BODY WIRES

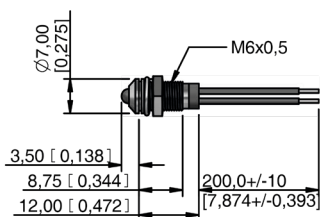

## SOLDER LUG/FASTON

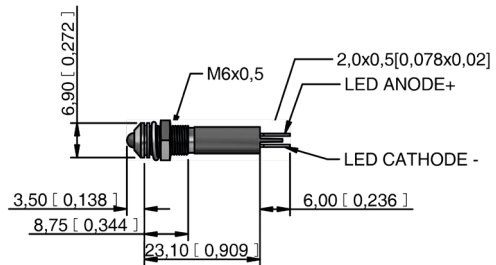

## PINS

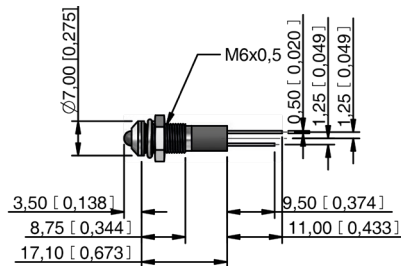

## REAR EPOXY PINS

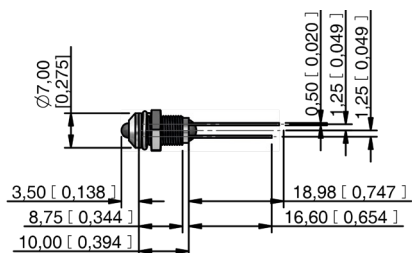

## SHORT BODY PINS

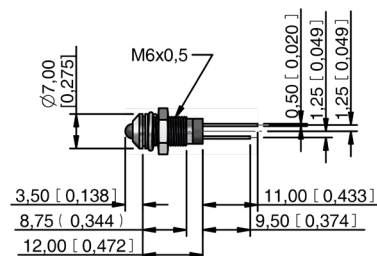

# Q6 series

Ø6 mm panel mount LED indicators

## FLUSH BEZEL



## SOLDER LUG/FASTON

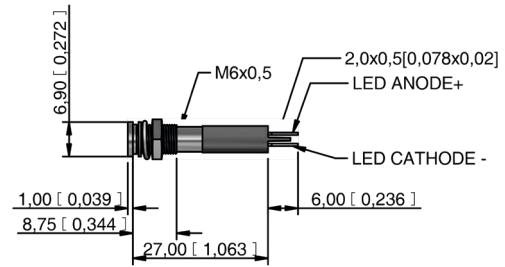

## WIRES

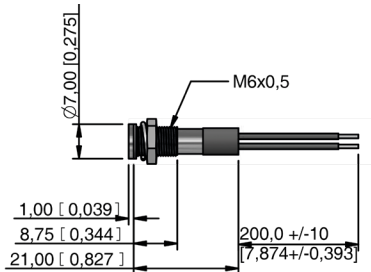

## PINS

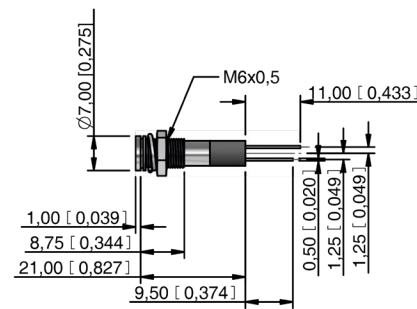

## REAR EPOXY WIRES

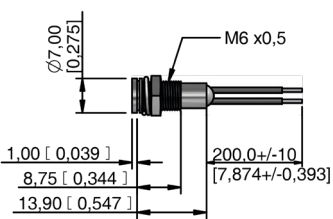

## REAR EPOXY PINS

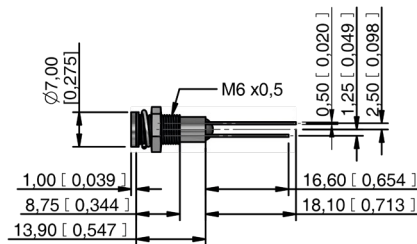

## SHORT BODY WIRES

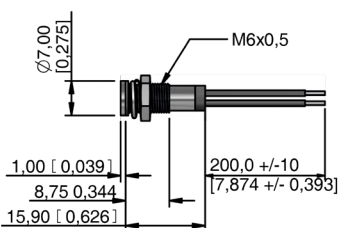

## SHORT BODY PINS

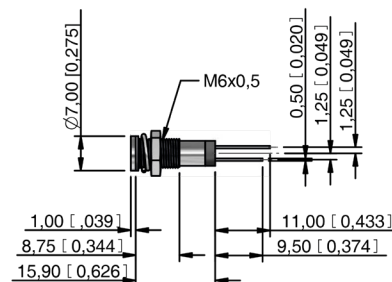

# Q6 series

Ø6 mm panel mount LED indicators

## RECESSED BEZEL



## WIRES

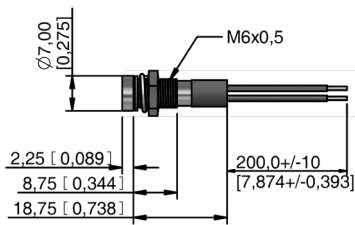

## REAR EPOXY WIRES

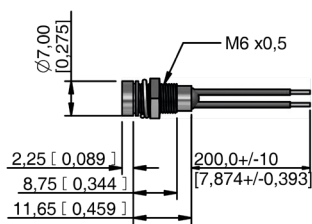

## SHORT BODY WIRES

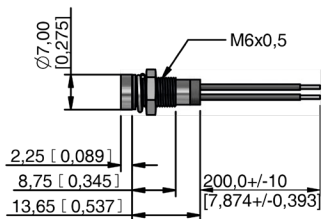

## SOLDER LUG/FASTON

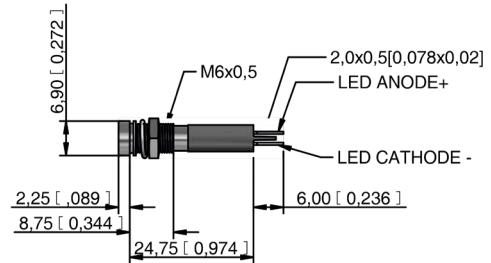

## PINS

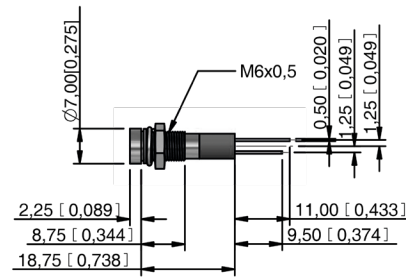

## REAR EPOXY PINS

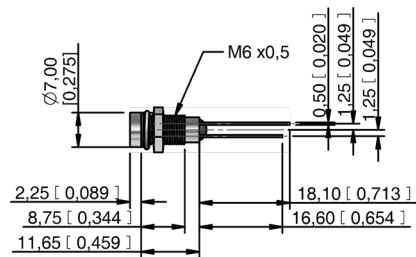

## SHORT BODY PINS

