

Q6 series

Ø6 mm panel mount LED indicators



DISTINCTIVE FEATURES

3 mm colored diffused epoxy lens or 3 mm water clear super bright LEDs

Prominent, recessed and flush bezel styles

(2.0 x 0.5) solder lug terminals, pins or (200 mm long) wire terminations, other lengths available on request



ENVIRONMENTAL SPECIFICATIONS

- IP67 sealing option (EN60529)
- Operating & Storage Temperature Range:
Rear plastic body: -30 °C to +65 °C (-22 °F to +149 °F)
Rear epoxy body: -40 °C to +85 °C (-40 °F to +185 °F)



GENERAL SPECIFICATIONS

- Max Reverse Voltage: 5 V
- Viewing Angle: 30–100° (dependant on model)
- Life Expectancy: 100,000 hours
- Torque: 4 cNm (dependent on option)
- Maximum panel thickness 7 mm



MATERIALS

- Plated brass bezel finished in bright chrome, black chrome or satin grey and moulded polycarbonate rear body



MOUNTING

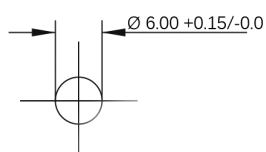

The company reserves the right to change specifications without notice.

All LED characteristics are dependent upon environmental conditions. Therefore published data should be considered nominal and subject to variations.



Q6 series

Ø6 mm panel mount LED indicators



ELECTRICAL SPECIFICATIONS

STANDARD LED INTENSITY

| LED COMPONENT SPECIFICATIONS | | | |
|-----------------------------------|------------------------|----------|-----------------|
| | Prominent and Recessed | Flush | Forward Voltage |
| HE Red | 40 mcd | 10 mcd | 2.0 V |
| Green | 50 mcd | 12 mcd | 2.2 V |
| Yellow | 30 mcd | 6 mcd | 2.1 V |
| Blue | 1,200 mcd | 100 mcd | 3.8 V |
| White | 1,200 mcd | 160 mcd | 3.8 V |
| Orange | 60 mcd | 10 mcd | 2.0 V |
| Bi-color (Typical) (Red/Green) | 20/15 mcd | 10/8 mcd | 2.0 V/2.2 V |

Bi-color - The color is changed by reversing the polarity of the supply voltage.

SUPER BRIGHT LED INTENSITY

| LED COMPONENT SPECIFICATIONS | | | |
|------------------------------|------------------------|-----------|-----------------|
| | Prominent and Recessed | Flush | Forward Voltage |
| HE Red | 1,000 mcd | 700 mcd | 2.2 V |
| Green | 1,200 mcd | 2,000 mcd | 3.5 V |
| Yellow | 2,000 mcd | 8,000 mcd | 2.3 V |
| Blue | 1,600 mcd | 200 mcd | 3.3 V |
| White | 1,200 mcd | 350 mcd | 3.3 V |
| Orange | 10,000 mcd | 500 mcd | 2.2 V |

HYPER BRIGHT LED INTENSITY

| LED COMPONENT SPECIFICATIONS | | | |
|------------------------------|------------------------|---------|-----------------|
| | Prominent and Recessed | Flush | Forward Voltage |
| HE Red | 3,700 mcd | 600 mcd | 2.2 V |
| Green | 2,000 mcd | 350 mcd | 3.2 V |
| Yellow | 1,200 mcd | 140 mcd | 2.0 V |
| Orange | 4,500 mcd | 400 mcd | 2.2 V |

- The operating voltage must not be exceeded by more than 10% as this will result in reduced life expectancy
- Luminous intensity is measured at 20 ma on a discrete led unless otherwise stated.
- Luminous intensities and color shades of white LEDs may vary within a batch.
- Luminous intensity will be reduced with lower operating current.

| Voltage | Operating Voltage | Operating Current |
|------------------|-------------------|---------------------|
| | (Min to Max) | (Typical All Types) |
| 02 (No Resistor) | 1.8 to 3.3 VDC | 20 mA max* |
| 6 VDC | 5.4 to 6.6 VDC | 20 mA |
| 12 VDC | 10.8 to 13.2 VDC | 20 mA |
| 24 VDC | 21.6 to 26.4 VDC | 20 mA |
| 28 VDC | 25.2 to 30.8 VDC | 20 mA |

* Customer to supply resistor for desired operating current.



BUILD YOUR PART NUMBER

| | | | | |
|---|---|---|--|---|
| <div style="border: 1px solid black; padding: 2px; width: 30px; margin: 0 auto;">Q</div> <p>SERIES</p> | <div style="border: 1px solid black; padding: 2px; width: 30px; margin: 0 auto;">6</div> <p>MOUNTING HOLE</p> <p>Ø6 mm</p> | <div style="border: 1px solid black; padding: 2px; width: 30px; margin: 0 auto;">P</div> <p>BEZEL STYLE</p> <ul style="list-style-type: none"> P Prominent R Recessed F Flush | <div style="border: 1px solid black; padding: 2px; width: 30px; margin: 0 auto;">1</div> <p>TERMINALS</p> <ul style="list-style-type: none"> 1 Solder Lug/ Fastons (2.0 x 0.5) 2 Pins 3 Wires | <div style="border: 1px solid black; padding: 2px; width: 30px; margin: 0 auto;">4</div> <p>BEZEL FINISH</p> <ul style="list-style-type: none"> C Bright Chrome B Black Chrome G Satin Grey |
| <div style="border: 1px solid black; padding: 2px; width: 30px; margin: 0 auto;">XX</div> <p>TYPE OF ILLUMINATION</p> <ul style="list-style-type: none"> XX Fixed Light KK Flashing Light (12 V – 28 VDC) YY Bi-color | <div style="border: 1px solid black; padding: 2px; width: 30px; margin: 0 auto;">R</div> <p>LED COLOR</p> <ul style="list-style-type: none"> R Red G Green Y Yellow B Blue W White O Orange HR Hyper Bright Red HG Hyper Bright Green HY Hyper Bright Yellow HO Hyper Bright Orange | <div style="border: 1px solid black; padding: 2px; width: 30px; margin: 0 auto;">SR</div> <p>LED COLOR</p> <ul style="list-style-type: none"> SR Super Bright Red SG Super Bright Green SY Super Bright Yellow SB Super Bright Blue SW Super Bright White SO Super Bright Orange RG Red/Green RY Red/Yellow GY Green/Yellow | <div style="border: 1px solid black; padding: 2px; width: 30px; margin: 0 auto;">02</div> <p>VOLTAGE</p> <ul style="list-style-type: none"> 02 no resistor* 06 6V DC 12 12 VDC 12A 12 VAC/DC 24 24 VDC 24A 24 VAC/DC 28 28 VDC 28A 28 VAC/DC <p>* please refer to the forward voltage in electrical specifications</p> | <div style="border: 1px solid black; padding: 2px; width: 30px; margin: 0 auto;">(Blank)</div> <p>SEALING</p> <ul style="list-style-type: none"> (Blank) Unsealed E IP67 |



ABOUT THIS SERIES

- Notice:** please note that not all combinations of above numbers are available.
- Gold faston terminal denotes anode (+), silver terminal denotes cathode (-)
 - Standard wire length is 200 mm, 24 AWG UL1061, red wire denotes anode (+), black wire denotes cathode (-) for other wire lengths consult APEM.
 - For LEDs with alternative voltages consult APEM
 - Bi-color leds, by connecting the gold solder lug (+) one color is produced, by reversing the supply voltage another color is produced – bi-colors are available up to 28 V in DC only.
 - Take care when soldering to the faston terminals (recommended solder temperature 300 °C - 3 sec)
 - Short body options are only available up to 24 VDC.

Q6 series

Ø6 mm panel mount LED indicators

PROMINENT BEZEL



WIRES



REAR EPOXY WIRES



SHORT BODY WIRES



SOLDER LUG/FASTON



PINS



REAR EPOXY PINS



SHORT BODY PINS



FLUSH BEZEL



SOLDER LUG/FASTON



WIRES



PINS

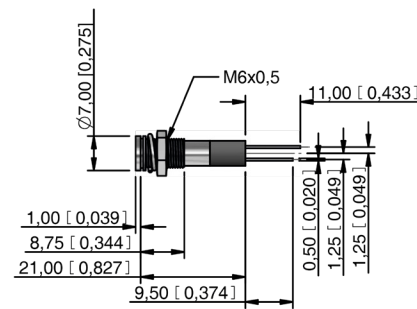

REAR EPOXY WIRES



REAR EPOXY PINS

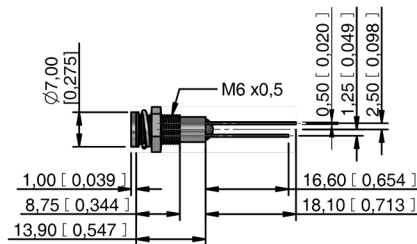

SHORT BODY WIRES

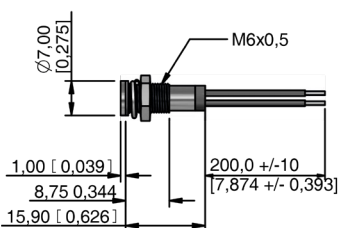

SHORT BODY PINS



Q6 series

Ø6 mm panel mount LED indicators

RECESSED BEZEL



WIRES



REAR EPOXY WIRES

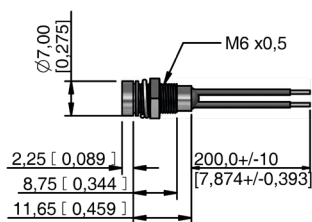

SHORT BODY WIRES

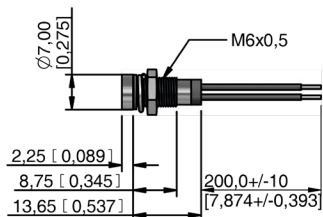

SOLDER LUG/FASTON

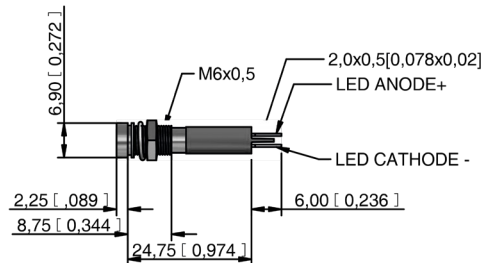

PINS

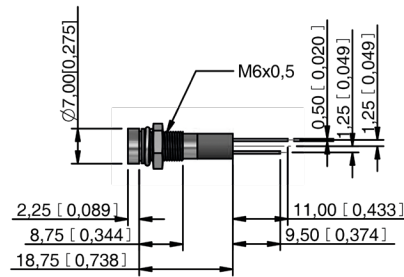

REAR EPOXY PINS

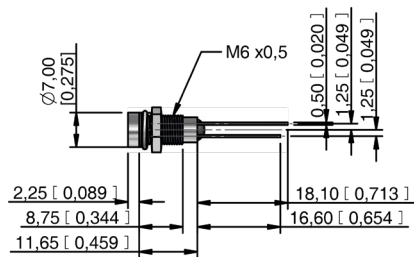

SHORT BODY PINS

