

## EMILY-O

~45° x 10° oval beam. 14.96 mm high lens.

### TECHNICAL SPECIFICATIONS:

Dimensions	Ø 26.0 mm
Height	15 mm
Fastening	tape, pin
ROHS compliant	yes ⓘ

### MATERIAL SPECIFICATIONS:

Component	Type	Material	Colour	Finish
EMILY-O	Single lens	PMMA	clear	
SPUTNIK-TAPE	Tape	PU tape	black	



### ORDERING INFORMATION:

Component	Type	Qty in box	MOQ	MPQ	Box weight (kg)
CA12066_EMILY-O » Box size: 480 x 280 x 300 mm	Single lens	1690	260	130	10.7

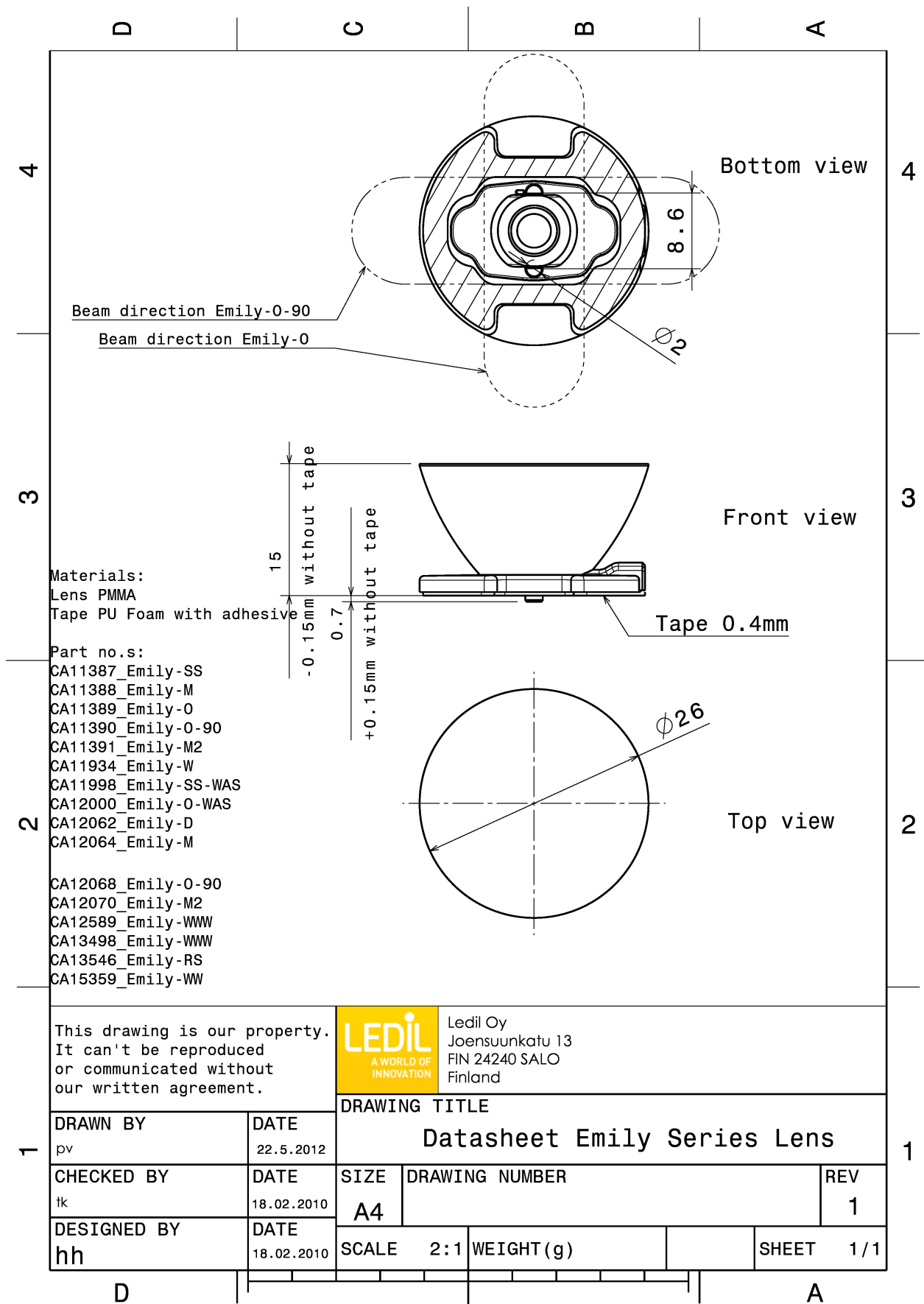

This drawing is our property. It can't be reproduced or communicated without our written agreement.

**LEDiL**  
A WORLD OF INNOVATION

Ledil Oy  
Joensuunkatu 13  
FIN 24240 SALO  
Finland

<b>DRAWN BY</b> pv		<b>DATE</b> 22.5.2012		<b>DRAWING TITLE</b> Datasheet Emily Series Lens				
<b>CHECKED BY</b> tk		<b>DATE</b> 18.02.2010		<b>SIZE</b> A4		<b>DRAWING NUMBER</b>		<b>REV</b> 1
<b>DESIGNED BY</b> hh		<b>DATE</b> 18.02.2010		<b>SCALE</b> 2:1		<b>WEIGHT (g)</b>		<b>SHEET</b> 1/1

#### PHOTOMETRIC DATA (MEASURED):

#### CREE

LED XD16  
 FWHM 47.0 + 8.0°  
 Efficiency 91 %  
 Peak intensity 5.4 cd/lm  
 LEDs/each optic 1  
 Light colour White  
 Required components:

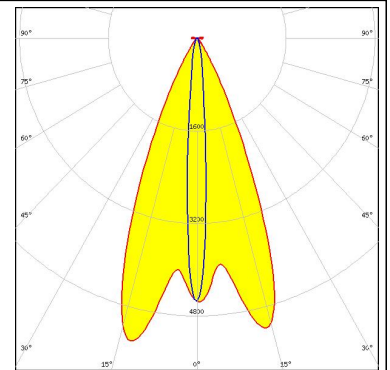

#### CREE

LED XM-L  
 FWHM 47.0 + 13.0°  
 Efficiency 90 %  
 LEDs/each optic 1  
 Light colour White  
 Required components:

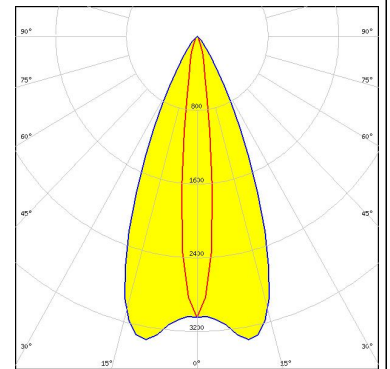

#### CREE

LED XM-L2  
 FWHM 47.0 + 14.0°  
 Efficiency 86 %  
 Peak intensity 3.6 cd/lm  
 LEDs/each optic 1  
 Light colour White  
 Required components:

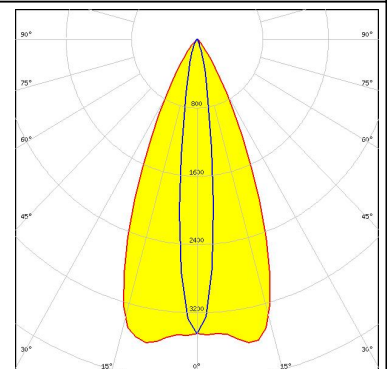
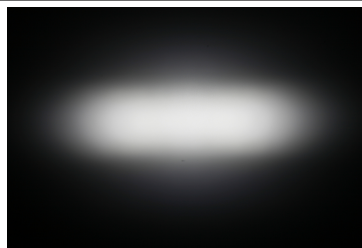

#### CREE

LED XP-G3  
 FWHM 47.0 + 11.0°  
 Efficiency 93 %  
 Peak intensity 4.2 cd/lm  
 LEDs/each optic 1  
 Light colour White  
 Required components:

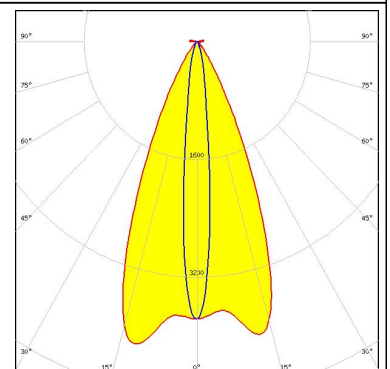
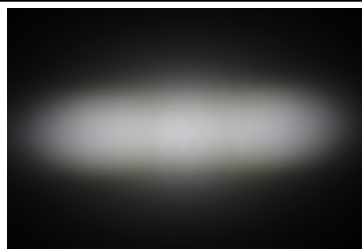

#### PHOTOMETRIC DATA (MEASURED):



LED XP-L HD  
 FWHM 46.0 + 14.0°  
 Efficiency 86 %  
 Peak intensity 3.7 cd/lm  
 LEDs/each optic 1  
 Light colour White  
 Required components:

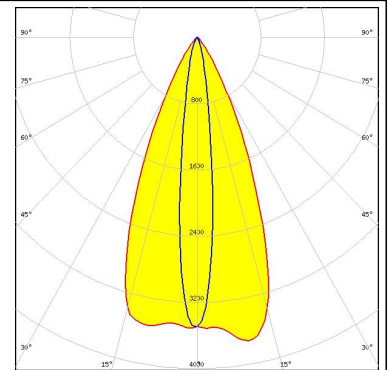
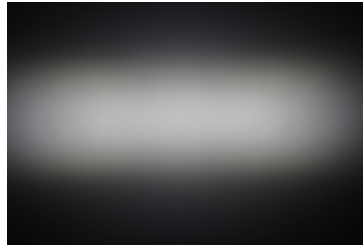

LED XP-L HI  
 FWHM 48.0 + 9.0°  
 Efficiency 86 %  
 Peak intensity 5.7 cd/lm  
 LEDs/each optic 1  
 Light colour White  
 Required components:

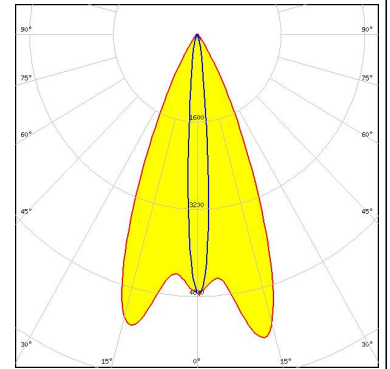

LED LUXEON A  
 FWHM 44.0 + 10.0°  
 Efficiency %  
 LEDs/each optic 1  
 Light colour White  
 Required components:



LED LUXEON Rebel ES  
 FWHM 44.0 + 10.0°  
 Efficiency 90 %  
 LEDs/each optic 1  
 Light colour White  
 Required components:

#### PHOTOMETRIC DATA (MEASURED):



#### PHOTOMETRIC DATA (SIMULATED):



LED XM-L HVW  
 FWHM 12.0 + 48.0°  
 Efficiency %  
 LEDs/each optic 1  
 Light colour White  
 Required components:



LED XP-G2 HE  
 FWHM 44.0 + 12.0°  
 Efficiency 92 %  
 Peak intensity 4.5 cd/lm  
 LEDs/each optic 1  
 Light colour White  
 Required components:

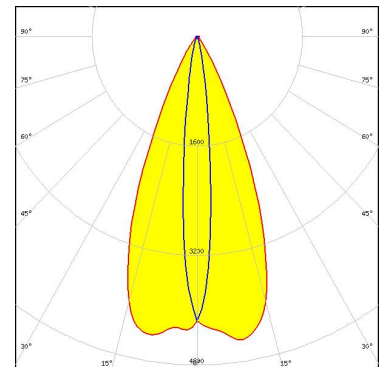

LED OSOLON Black  
 FWHM 11.0 + 44.0°  
 Efficiency %  
 Peak intensity 5.1 cd/lm  
 LEDs/each optic 1  
 Light colour White  
 Required components:

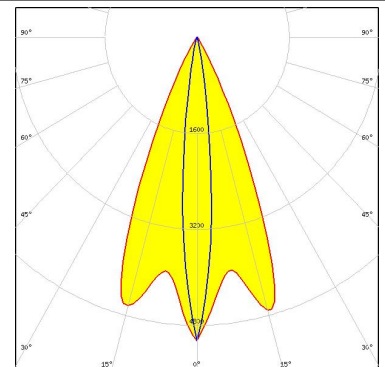

LED OSOLON Black Flat  
 FWHM 47.0 + 9.0°  
 Efficiency 94 %  
 Peak intensity 6.7 cd/lm  
 LEDs/each optic 1  
 Light colour White  
 Required components:

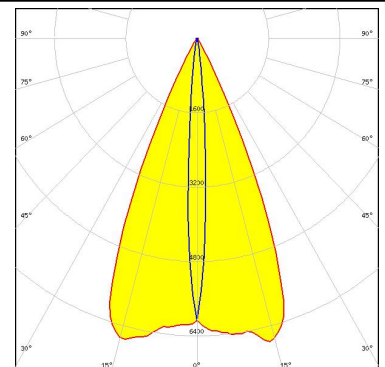

### GENERAL INFORMATION:

NOTE: The typical beam angle will be changed by different color, chip size and chip position tolerance. The typical total beam angle is the full angle measured where the luminous intensity is half of the peak value.

### MATERIALS:

As part of our continuous research and improvement processes, and to ensure the best possible quality and availability of our products, LEDiL reserves the right to change material grades without notice.

### PRODUCT DATA USER AGREEMENT AND DISCLAIMER:

The measured data in the provided downloadable LEDiL Product Datasheets and Mechanical 2D-Drawings is rounded and provided as reference for planning. LEDiL Oy's optical specifications have been verified by conducting performance testing of the products in accordance with the company's quality system. The reported data are averaged results of multiple measurements with typical variation. LEDiL Oy reserves the right to without prior notification make changes and improvements to its products.

LEDiL Oy assumes neither warranty, nor guarantee nor any other liability of any kind for the contents and correctness of the provided data. The provided data has been generated with highest diligence but the provided data may in reality not represent the complete possible variation range of all intrinsic parameters. Therefore, in certain cases a deviation from the provided data could occur.

LEDiL Oy reserves the right to undertake technical changes of its products without further notification which could lead to changes in the provided data. LEDiL Oy assumes no liability of any kind for the possible deviation from any provided data or any other damage resulting from the usage of the provided data.

The user agrees to this disclaimer and user agreement with the download or usage of the provided files.

#### LEDiL Oy

Joensuunkatu 13  
FI-24240 SALO  
Finland

#### LEDiL Inc.

228 West Page Street  
Suite D  
Sycamore IL 60178  
USA

#### Local sales and technical support

[www.ledil.com/  
where\\_to\\_buy](http://www.ledil.com/where_to_buy)

#### Shipping locations

Salo, Finland  
Hong Kong, China

#### Distribution Partners

[www.ledil.com/  
where\\_to\\_buy](http://www.ledil.com/where_to_buy)