

## Complementary power Darlingtons

### Features

- Good  $h_{FE}$  linearity
- High  $f_T$  frequency
- Monolithic Darlingtons configuration with integrated antiparallel collector-emitter diode

### Applications

- Linear and switching industrial equipment

### Description

The devices are manufactured in planar base island technology with monolithic Darlingtons configuration.

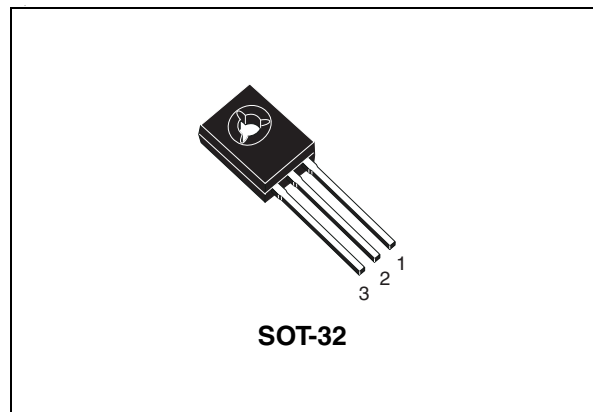

**Figure 1. Internal schematic diagram**

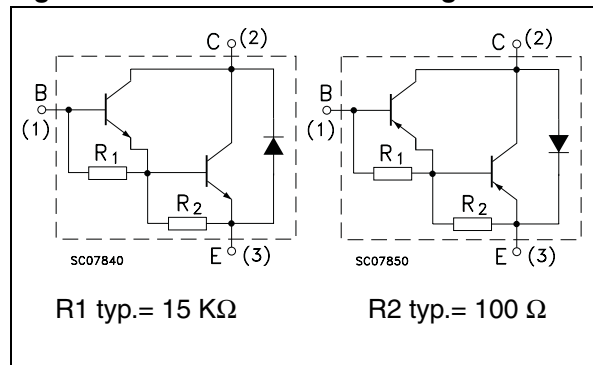

**Table 1. Device summary**

Order codes	Marking	Package	Packaging
BD677	BD677	SOT-32	Tube
BD677A	BD677A		
BD678	BD678		
BD678A	BD678A		
BD679	BD679		
BD679A	BD679A		
BD680	BD680		
BD680A	BD680A		
BD681	BD681		
BD682	BD682		

---

# Contents

<b>1</b>	<b>Absolute maximum ratings</b> .....	<b>3</b>
<b>2</b>	<b>Electrical characteristics</b> .....	<b>4</b>
2.1	Typical characteristic (curves) .....	6
2.2	Test circuit .....	8
<b>3</b>	<b>Package mechanical data</b> .....	<b>9</b>
<b>4</b>	<b>Revision history</b> .....	<b>11</b>

# 1 Absolute maximum ratings

**Table 2. Absolute maximum ratings**

Symbol	Parameter	Value			Unit	
		NPN	BD677 BD677A	BD679 BD679A		BD681
		PNP	BD678 BD678A	BD680 BD680A		BD682
V <sub>CBO</sub>	Collector-base voltage (I <sub>E</sub> = 0)	60	80	100	V	
V <sub>CEO</sub>	Collector-emitter voltage (I <sub>B</sub> = 0)					
V <sub>EBO</sub>	Emitte-base voltage (I <sub>C</sub> = 0)	5			V	
I <sub>C</sub>	Collector current	4			A	
I <sub>CM</sub>	Collector peak current	6			A	
I <sub>B</sub>	Base current	0.1			A	
P <sub>TOT</sub>	Total dissipation at T <sub>case</sub> = 25°C	40			W	
T <sub>stg</sub>	Storage temperature	-65 to 150			°C	
T <sub>J</sub>	Max. operating junction temperature	150			°C	

*Note:* For PNP types voltage and current values are negative

## 2 Electrical characteristics

( $T_{case} = 25^{\circ}C$ ; unless otherwise specified)

**Table 3. Electrical characteristics**

Symbol	Parameter	Test conditions	Min.	Typ.	Max.	Unit
$I_{CEO}$	Collector cut-off current ( $I_B = 0$ )	$V_{CE} = \text{half rated } V_{CEO}$			0.5	mA
$I_{CBO}$	Collector cut-off current ( $I_E = 0$ )	$V_{CE} = \text{rated } V_{CBO}$ $V_{CE} = \text{rated } V_{CBO}$ $T_C = 100^{\circ}C$			0.2 2	mA
$I_{EBO}$	Emitter cut-off current ( $I_C = 0$ )	$V_{EB} = 5 V$			2	mA
$V_{CEO(sus)}^{(1)}$	Collector-emitter sustaining voltage ( $I_B = 0$ )	for BD677, BD677A, BD678, BD678A $I_C = 50 \text{ mA}$	60			V
		for BD679, BD679A, BD680, BD680A $I_C = 50 \text{ mA}$	80			
		for BD681, BD682 $I_C = 50 \text{ mA}$	100			
$V_{CE(sat)}^{(1)}$	Collector-emitter saturation voltage	for BD677, BD678, BD679, BD680, BD681, BD682 $I_C = 1.5 \text{ A}$ $I_B = 30 \text{ mA}$			2.5	V
		for BD677A, BD678A, BD679A, BD680A $I_C = 2 \text{ A}$ $I_B = 40 \text{ mA}$			2.8	
$V_{BE}^{(1)}$	Base-emitter voltage	for BD677, BD678, BD679, BD680, BD681, BD682 $I_C = 1.5 \text{ A}$ $V_{CE} = 3 \text{ V}$			2.5	V
		for BD677A, BD678A, BD679A, BD680A $I_C = 2 \text{ A}$ $V_{CE} = 3 \text{ V}$				

Table 3. Electrical characteristics (continued)

Symbol	Parameter	Test conditions	Min.	Typ.	Max.	Unit
$h_{FE}^{(1)}$	DC current gain	for BD677, BD678, BD679, BD680, BD681, BD682 $I_C = 1.5 \text{ A}$ $V_{CE} = 3 \text{ V}$	750			
		for BD677A, BD678A, BD679A, BD680A $I_C = 2 \text{ A}$ $V_{CE} = 3 \text{ V}$				

1. Pulsed duration = 300 ms, duty cycle  $\geq 1.5\%$ .

**Note:** For PNP types voltage e current values are negative.

## 2.1 Typical characteristic (curves)

Figure 2. DC current gain (NPN)

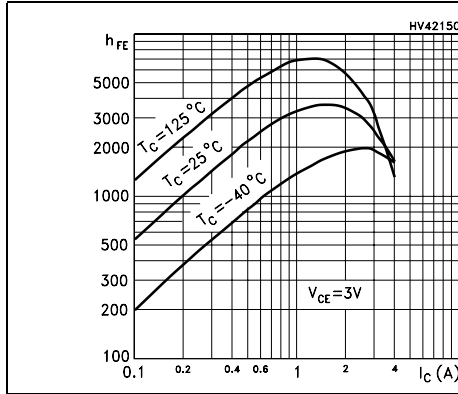

Figure 3. DC current gain (PNP)

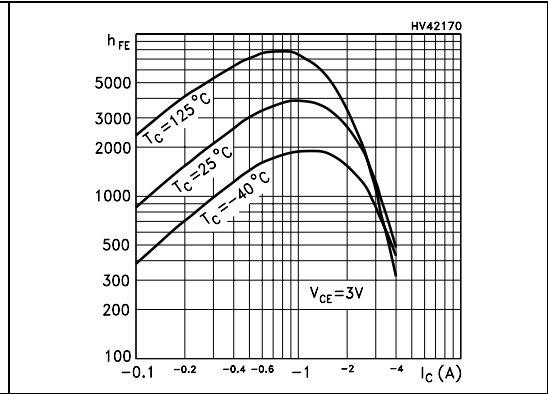

Figure 4. DC current gain (NPN)

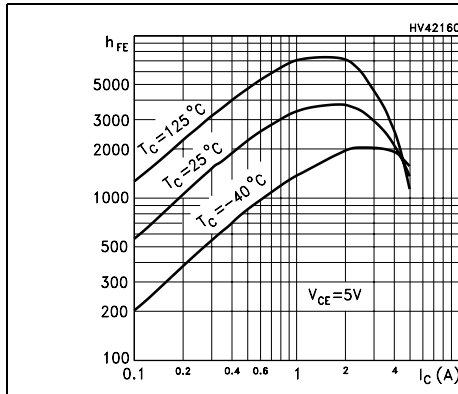

Figure 5. DC current gain (PNP)

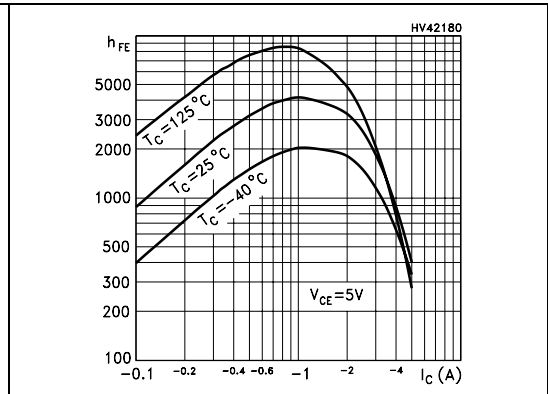

Figure 6. Collector-emitter saturation voltage (NPN)

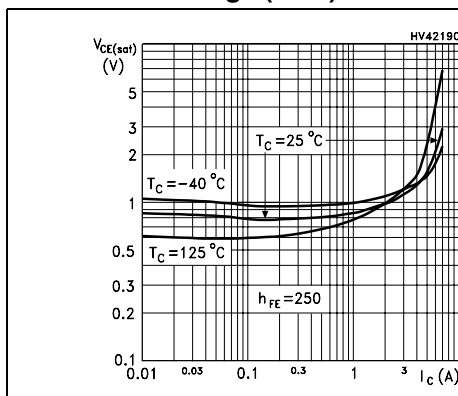
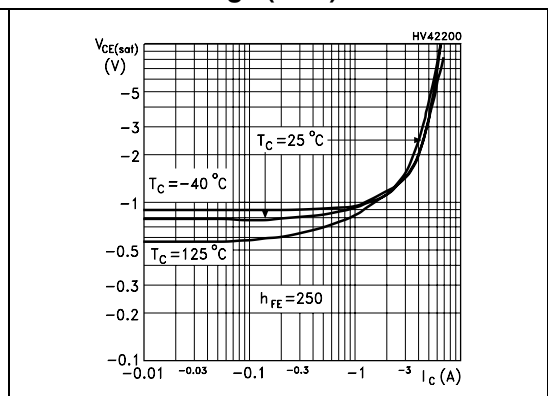

Figure 7. Collector-emitter saturation voltage (PNP)



**Figure 8. Base-emitter saturation voltage (NPN)**



**Figure 9. Base-emitter saturation voltage (PNP)**



**Figure 10. Base-emitter voltage (NPN)**

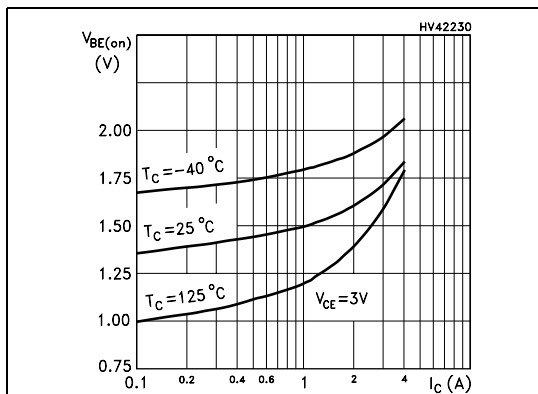

**Figure 11. Base-emitter voltage (PNP)**

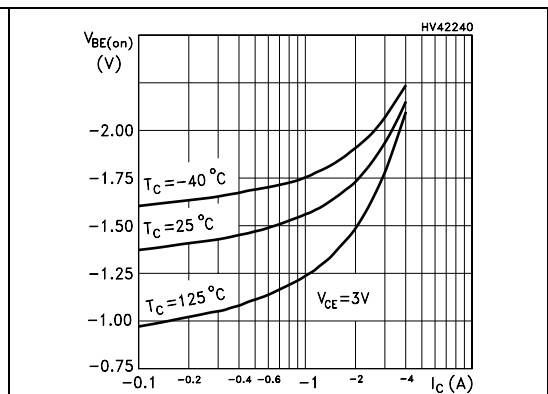

**Figure 12. Resistive load switching time (NPN, on)**

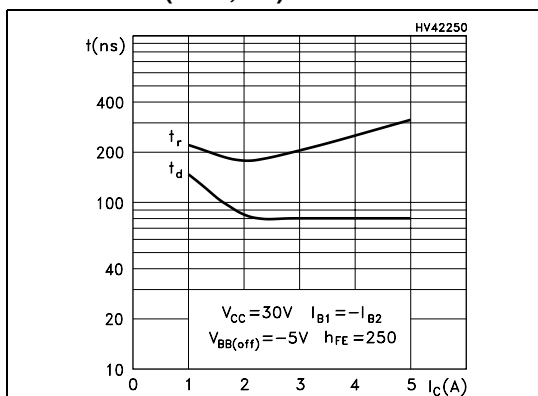

**Figure 13. Resistive load switching time (PNP, on)**

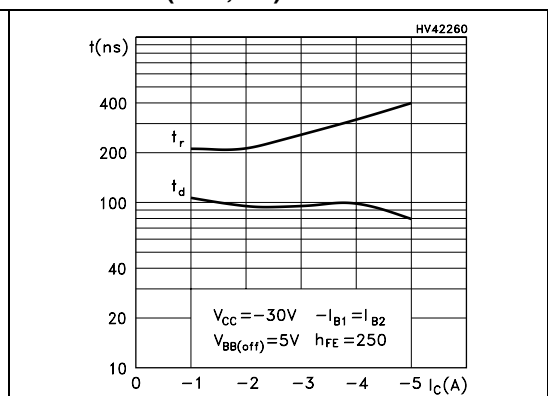

**Figure 14. Resistive load switching time (NPN, off)**      **Figure 15. Resistive load switching time (PNP, off)**



## 2.2 Test circuit

**Figure 16. Resistive load switching test circuit**



*Note: For PNP types voltage e current values are negative.*



### 3 Package mechanical data

In order to meet environmental requirements, ST offers these devices in ECOPACK® packages. These packages have a lead-free second level interconnect . The category of second level interconnect is marked on the package and on the inner box label, in compliance with JEDEC Standard JESD97. The maximum ratings related to soldering conditions are also marked on the inner box label. ECOPACK is an ST trademark. ECOPACK specifications are available at: [www.st.com](http://www.st.com)

**SOT-32 (TO-126) MECHANICAL DATA**

DIM.	mm.		
	MIN.	TYP	MAX.
A	2.4		2.9
B	0.64		0.88
B1	0.39		0.63
D	10.5		11.05
E	7.4		7.8
e	2.04	2.29	2.54
e1	4.07	4.58	5.08
L	15.3		16
P	2.9		3.2
Q		3.8	
Q1	1		1.52
H2		2.15	
l		1.27	



## 4 Revision history

**Table 4. Document revision history**

Date	Revision	Changes
21-Jun-2004	4	
14-Jan-2008	5	<ol style="list-style-type: none"><li data-bbox="683 521 1412 555">1. Technology change from epybase to planar.</li><li data-bbox="683 555 1412 622">2. Updated <i>Section 2.1: Typical characteristic (curves) on page 6</i></li><li data-bbox="683 622 1412 656">3. Content reworked to improve readability.</li></ol>

**Please Read Carefully:**

Information in this document is provided solely in connection with ST products. STMicroelectronics NV and its subsidiaries ("ST") reserve the right to make changes, corrections, modifications or improvements, to this document, and the products and services described herein at any time, without notice.

All ST products are sold pursuant to ST's terms and conditions of sale.

Purchasers are solely responsible for the choice, selection and use of the ST products and services described herein, and ST assumes no liability whatsoever relating to the choice, selection or use of the ST products and services described herein.

No license, express or implied, by estoppel or otherwise, to any intellectual property rights is granted under this document. If any part of this document refers to any third party products or services it shall not be deemed a license grant by ST for the use of such third party products or services, or any intellectual property contained therein or considered as a warranty covering the use in any manner whatsoever of such third party products or services or any intellectual property contained therein.

**UNLESS OTHERWISE SET FORTH IN ST'S TERMS AND CONDITIONS OF SALE ST DISCLAIMS ANY EXPRESS OR IMPLIED WARRANTY WITH RESPECT TO THE USE AND/OR SALE OF ST PRODUCTS INCLUDING WITHOUT LIMITATION IMPLIED WARRANTIES OF MERCHANTABILITY, FITNESS FOR A PARTICULAR PURPOSE (AND THEIR EQUIVALENTS UNDER THE LAWS OF ANY JURISDICTION), OR INFRINGEMENT OF ANY PATENT, COPYRIGHT OR OTHER INTELLECTUAL PROPERTY RIGHT.**

**UNLESS EXPRESSLY APPROVED IN WRITING BY AN AUTHORIZED ST REPRESENTATIVE, ST PRODUCTS ARE NOT RECOMMENDED, AUTHORIZED OR WARRANTED FOR USE IN MILITARY, AIR CRAFT, SPACE, LIFE SAVING, OR LIFE SUSTAINING APPLICATIONS, NOR IN PRODUCTS OR SYSTEMS WHERE FAILURE OR MALFUNCTION MAY RESULT IN PERSONAL INJURY, DEATH, OR SEVERE PROPERTY OR ENVIRONMENTAL DAMAGE. ST PRODUCTS WHICH ARE NOT SPECIFIED AS "AUTOMOTIVE GRADE" MAY ONLY BE USED IN AUTOMOTIVE APPLICATIONS AT USER'S OWN RISK.**

Resale of ST products with provisions different from the statements and/or technical features set forth in this document shall immediately void any warranty granted by ST for the ST product or service described herein and shall not create or extend in any manner whatsoever, any liability of ST.

ST and the ST logo are trademarks or registered trademarks of ST in various countries.

Information in this document supersedes and replaces all information previously supplied.

The ST logo is a registered trademark of STMicroelectronics. All other names are the property of their respective owners.

© 2008 STMicroelectronics - All rights reserved

STMicroelectronics group of companies

Australia - Belgium - Brazil - Canada - China - Czech Republic - Finland - France - Germany - Hong Kong - India - Israel - Italy - Japan - Malaysia - Malta - Morocco - Singapore - Spain - Sweden - Switzerland - United Kingdom - United States of America

[www.st.com](http://www.st.com)