

SinglFuse™ SF-0603FPxxx F Series Features

- Single blow fuse for overcurrent protection
- 1608 (EIA 0603) miniature footprint
- Fast-acting precision fuse
- UL 248-14 listed
- RoHS compliant* and halogen free**
- Thin film chip design
- Surface mount packaging for automated assembly

SF-0603FPxxx F Series - Fast Acting Precision Surface Mount Fuses

Electrical Characteristics

Model	Rated Current (Amps)	Fusing Time	Resistance (Ω) Typ.***	Rated Voltage	Interrupting Rating	Typical I ² t (A ² s) ****
SF-0603FP015F-2	0.15	Open within 5 sec. at 200 % rated current	2.20	DC 65 V	DC 35 V 50 A AC 65 V 13 A	0.0006
SF-0603FP020F-2	0.20		1.30			0.0014
SF-0603FP025F-2	0.25		1.10			0.0016
SF-0603FP0375F-2	0.375		0.48			0.0040
SF-0603FP050F-2	0.50		0.185			0.0120
SF-0603FP075F-2	0.75		0.112			0.0210
SF-0603FP100F-2	1.00		0.069			0.0420
SF-0603FP125F-2	1.25		0.048			0.0520
SF-0603FP150F-2	1.50		0.037	0.0710		
SF-0603FP175F-2	1.75		0.031	DC 35 V	DC 35 V 35 A AC 24 V 50 A	0.10
SF-0603FP200F-2	2.00		0.026			0.14
SF-0603FP250F-2	2.50		0.021			0.24
SF-0603FP300F-2	3.00		0.0176			0.33
SF-0603FP350F-2	3.50		0.0148			0.49
SF-0603FP400F-2	4.00		0.0125			0.63
SF-0603FP500F-2	5.00		0.0095			1.10

*** Resistance value measured with ≤10 % rated current at 25 °C ambient.

**** Melting I²t calculated at 0.001 second pre-arcing time.

Reliability Testing

No.	Test	Requirement	Test Condition	Test Reference
1	Bending	≤1 A: DCR change ≤ ±10 % >1 A: DCR change ≤ ±20 %	2 mm	Refer to STP document
2	Solderability	Minimum 95 % coverage	One dip at 255 °C for 5 seconds	MIL-STD-202 Method 208
3	Thermal shock	DCR change ≤ ±10 % No mechanical damage	100 cycles between -55 °C and +125 °C	MIL-STD-202 Method 107
4	Moisture resistance	DCR change ≤ ±10 % No excessive corrosion	10 cycles	MIL-STD-202 Method 106
5	Salt spray	DCR change ≤ ±10 % No excessive corrosion	48 hour exposure, 5 % salt solution	MIL-STD-202 Method 101
6	Mechanical vibration	DCR change ≤ ±10 % No mechanical damage	0.4 inch D.A. or 30 G between 5-3000 Hz	MIL-STD-202 Method 204
7	Mechanical shock	DCR change ≤ ±10 % No mechanical damage	1500 G, 0.5 ms, half-sine shocks	MIL-STD-202 Method 213
8	Life	No electrical "opens" during testing Voltage drop change shall be less than ±10 % of initial value	75 % rated current for 2000 hours at ambient temperature between +20 °C and +30 °C	Refer to STP document

Agency Recognition

UL File Number E198545

<http://www.ul.com/> Follow link to Online Certificates Directory, then enter UL File No. E198545, or [click here](#)

* RoHS Directive 2002/95/EC Jan. 27, 2003 including annex and RoHS Recast 2011/65/EU June 8, 2011.

** Bourns considers a product to be "halogen free" if (a) the Bromine (Br) content is 900 ppm or less; (b) the Chlorine (Cl) content is 900 ppm or less; and (c) the total Bromine (Br) and Chlorine (Cl) content is 1500 ppm or less.

"SinglFuse" is a trademark of Bourns, Inc.
Specifications are subject to change without notice.
The device characteristics and parameters in this data sheet can and do vary in different applications and actual device performance may vary over time.
Users should verify actual device performance in their specific applications.

SingIFuse™ SF-0603FPxxxF Series Applications

- Portable memory
- LCD monitors
- Disk drives
- PDAs
- Digital cameras
- MP3 players
- Cell phones
- Rechargeable battery packs
- Battery chargers
- Set-top boxes
- Industrial controllers
- Battery Management Systems (BMS)
- LED lighting
- Power tools

SF-0603FPxxxF Series - Fast Acting Precision Surface Mount Fuses BOURNS®

Environmental Characteristics

Operating Temperature.....-55 °C to +90 °C
 Storage Conditions
 Temperature +5 °C to +35 °C
 Humidity..... 40 % to 75 %
 Shelf Life.....2 years from manufacturing date
 Moisture Sensitivity Level..... 1
 ESD Classification (HBM)..... Class 6

Typical Part Marking

Represents total content. Layout may vary.



RATED CURRENT (A)	
· = 0.150	II = 1.500
.. = 0.200	= = 1.750
· · = 0.250	≡ = 2.000
·· · = 0.375	H = 2.500
I = 0.500	III = 3.000
— = 0.750	HH = 3.500
+ = 1.000	□ = 4.000
x = 1.250	○ = 5.000

How to Order

SF - 0603 FP 015 F - 2

SingIFuse™
 Product Designator
 SMD Footprint
 1608 = (EIA 0603) size
 Fuse Blow Type
 FP = Fast acting precision
 Rated Current
 015 ~ 500 (150 mA ~ 5.0 A)
 Structure Type
 F = Thin film
 Packaging Type
 - 2 = Tape & Reel

Construction

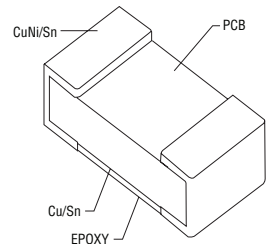

Packaging Quantity

8,000 pieces per 7-inch reel

Product Dimensions

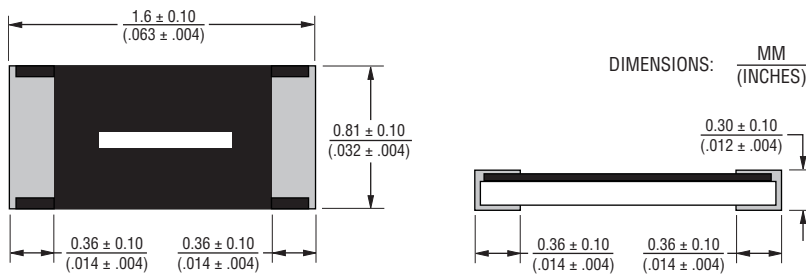

Recommended Pad Layout

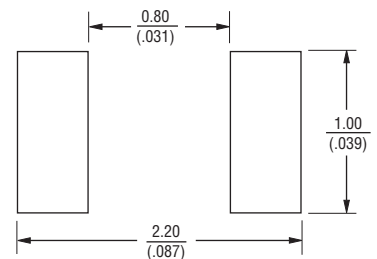

Current Rating Thermal Derating Curve

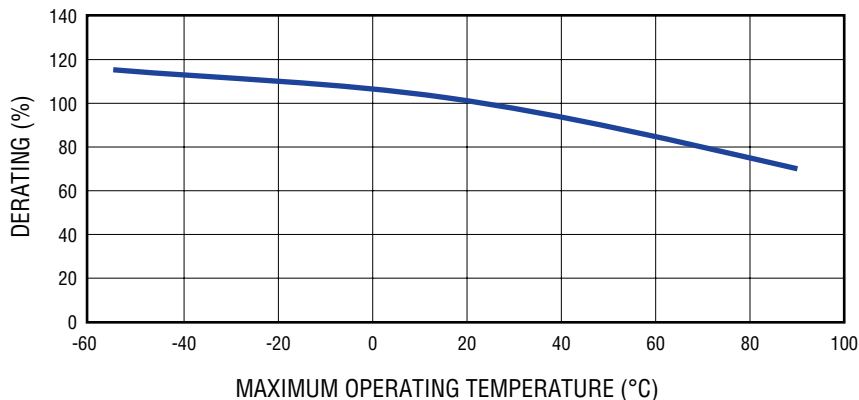

Specifications are subject to change without notice.
 The device characteristics and parameters in this data sheet can and do vary in different applications and actual device performance may vary over time.
 Users should verify actual device performance in their specific applications.

Solder Reflow Recommendations

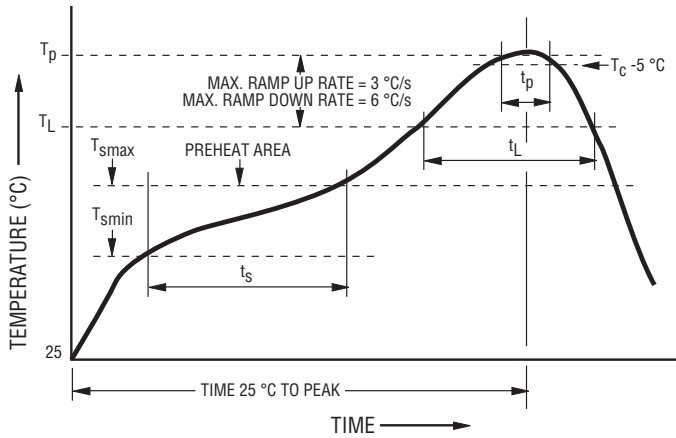

Profile Feature	Pb-Free Assembly
Preheat / Soak: Temperature Min. (T_{smin}) Temperature Max. (T_{smax}) Time (t_s) from (T_{smin} to T_{smax})	150 °C 200 °C 60~120 seconds
Ramp Up Rate (T_l to T_d)	3 °C / second max.
Liquidous Temperature (T_l) Time (t_L) maintained above T_l	217 °C 60~150 seconds
Peak Package Body Temperature (T_d)	260 °C
Time (t_p)* within 5 °C of the specified classification temperature (T_c)	30 seconds*
Ramp Down Rate (T_d to T_l)	6 °C / second max.
Time 25 °C to Peak Temperature	8 minutes max.

* Tolerance for peak profile temperature (T_p) is defined as a supplier minimum and a user maximum.

Recommended Temperature Profile for Wave Soldering



Wave soldering is suitable for 0603 size models.

Average Pre-Arcing Time vs. Current Curves



Average I^2t vs. t Curves

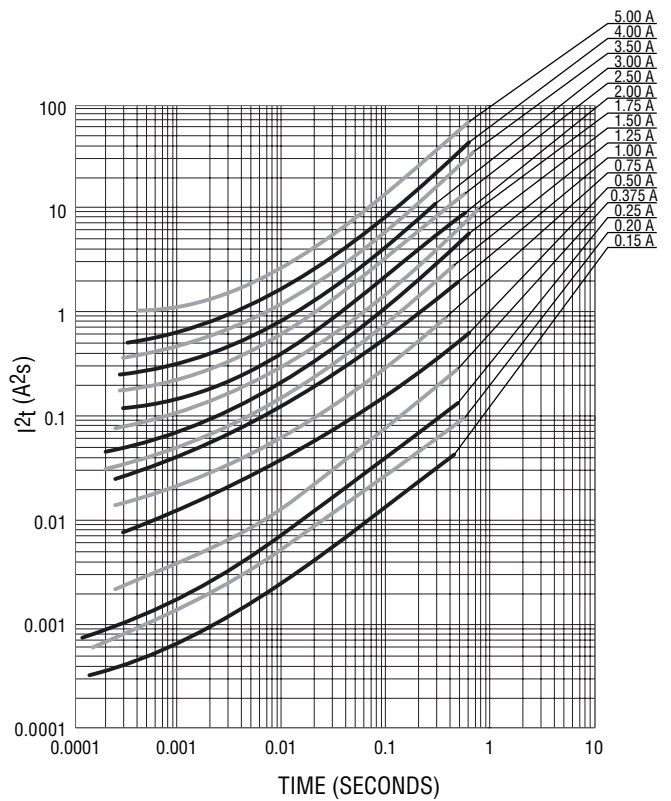

BOURNS®

Asia-Pacific: Tel: +886-2 2562-4117 • Email: asiacus@bourns.com

EMEA: Tel: +36 88 520 390 • Email: eurocus@bourns.com

The Americas: Tel: +1-951 781-5500 • Email: americus@bourns.com

www.bourns.com

SF-0603FPxxxF Series Tape and Reel Packaging Specifications

BOURNS®

Tape Dimensions	SF-0603FPxxxF Series per EIA 481-2
W	$\frac{8.10 \pm 0.20}{(.319 \pm .008)}$
P ₀	$\frac{4.0 \pm 0.10}{(.157 \pm .004)}$
P ₁	$\frac{2.0 \pm 0.05}{(.079 \pm .002)}$
P ₂	$\frac{2.0 \pm 0.05}{(.079 \pm .002)}$
A ₀	$\frac{1.00 \pm 0.10}{(.039 \pm .004)}$
B ₀	$\frac{1.80 \pm 0.10}{(.071 \pm .004)}$
F	$\frac{3.50 \pm 0.05}{(.138 \pm .002)}$
E ₁	$\frac{1.75 \pm 0.10}{(.069 \pm .004)}$
D ₀	$\frac{1.55 \pm 0.05}{(.061 \pm .002)}$
T	$\frac{0.60 \pm 0.08}{(.024 \pm .003)}$

PACKAGING: Paper tape, 8,000 pcs. per reel

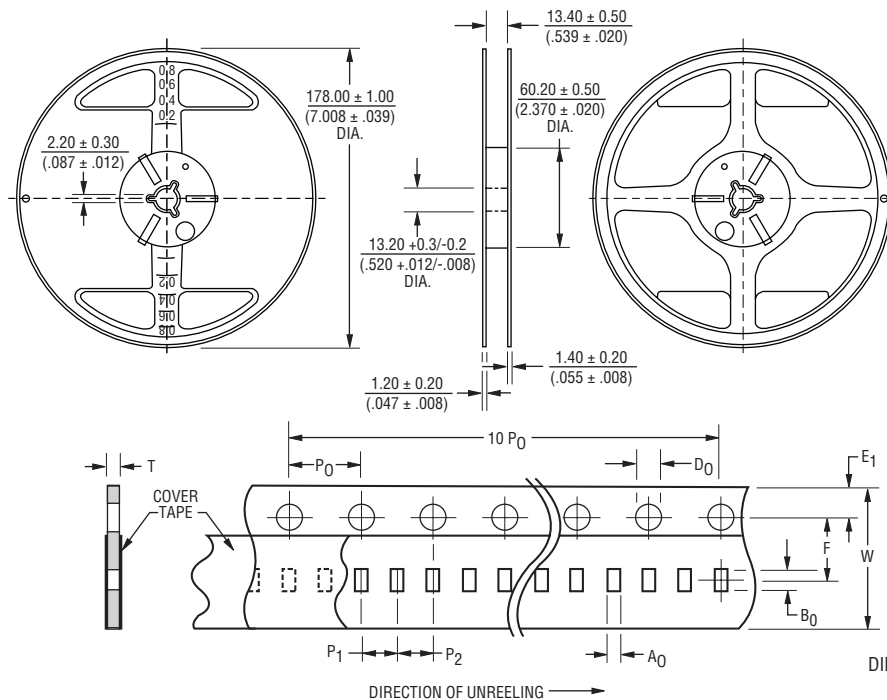

Specifications are subject to change without notice.

The device characteristics and parameters in this data sheet can and do vary in different applications and actual device performance may vary over time. Users should verify actual device performance in their specific applications.