

REV.	DESCRIPTION	DATE	APPROVED
B	Engineering Release	07/15/15	J. C.
C	Added Color Options, Sheet #2	01/25/16	J. C.

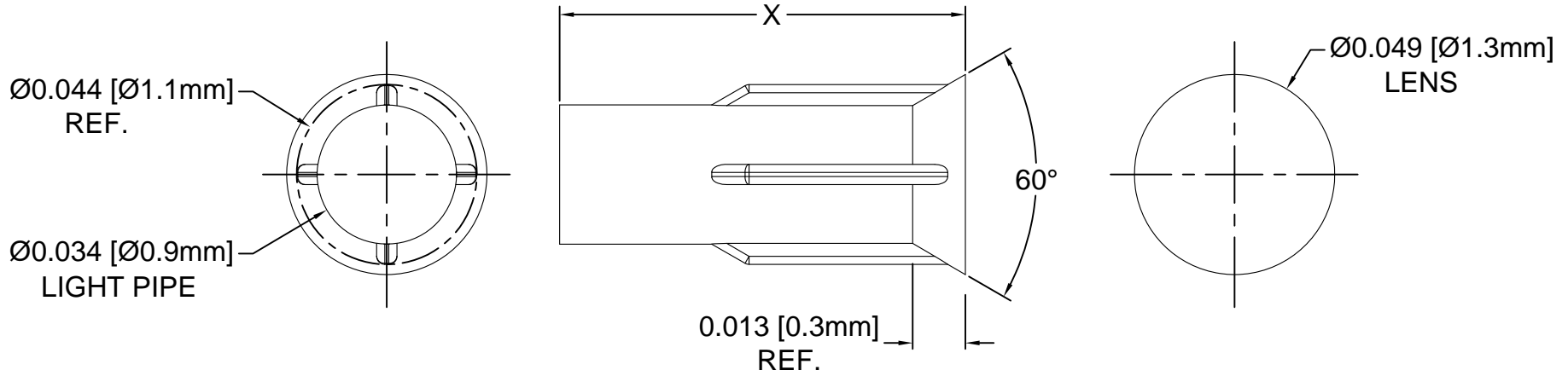

Part No.	X = Body Length
PLPC1-100	0.100 (2.5mm)
PLPC1-125	0.125 (3.2mm)
PLPC1-188	0.188 (4.8mm)
PLPC1-250	0.250 (6.4mm)
PLPC1-313	0.313 (7.9mm)
PLPC1-375	0.375 (9.5mm)
PLPC1-500	0.500 (12.7mm)
PLPC1-3MM	3mm (0.118")
PLPC1-4MM	4mm (0.157")
PLPC1-5MM	5mm (0.197")
PLPC1-6MM	6mm (0.236")
PLPC1-7MM	7mm (0.276")
PLPC1-8MM	8mm (0.315")
PLPC1-9MM	9mm (0.354")
PLPC1-10MM	10mm (0.394")

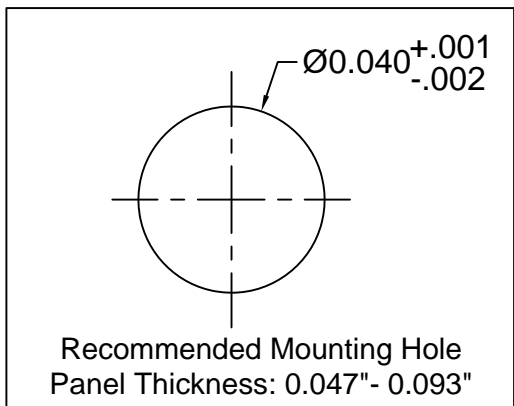

STANDARD TOLERANCE (UNLESS OTHERWISE SPECIFIED)		 4 THOMAS, IRVINE, CA. 92618 TEL: (949) 951-8808 FAX: (949) 951-3974	
DECIMALS	ANGULAR		
.X ± .1	X° ± 1°	TITLE: PRESS-FIT, PANEL MOUNT LIGHT PIPE, FLUSH, 1mm	
.XX ± .01			
.XXX ± .005		PART NO: PLPC1-XXX	REVISION: C
DESIGNED: A. Wright	DATE: 04/24/15	CAGE CODE : 32559 SHEET # 1 OF 2	
CHECKED: B. Oliver	DATE: 04/24/15	CAD GENERATED DOCUMENT, DO NOT MEASURE DRAWING.	

- 2. MATERIAL: POLYCARBONATE, 94V-0, CLEAR.
- 1. GENERAL SPECIFICATIONS: BIVAR MOLDED COMPONENT SPECIFICATION BV00-E101 and BSMC-1001.

OTHER AVAILABLE COLORS

* SEE TABLE FOR ORDERING INFORMATION

REV.	DESCRIPTION	DATE	APPROVED
	SEE SHEET #1		



COLOR	Order Code
BLUE	BE
BLACK	BK
GREEN	GN
GRAY	GY
RED	RD
YELLOW	YW

NOTE: LEAVE ORDER CODE BLANK IF NO COLOR IS DESIRED.

3. PARTS ARE DYED TO COLOR UPON REQUEST.

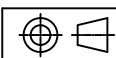
STANDARD TOLERANCE (UNLESS OTHERWISE SPECIFIED) DECIMALS ANGULAR		BIVAR [®] 4 THOMAS, IRVINE, CA. 92618 TEL: (949) 951-8808 FAX: (949) 951-3974	
			
DESIGNED: K. Aukshunas	DATE: 01/25/16	TITLE: PRESS-FIT, PANEL MOUNT, LIGHT PIPE, FLUSH, 1mm	REVISION: C
CHECKED: J. Chiang	DATE: 01/25/16	PART NO: PLPC1-XXX	CAGE CODE : 32559 SHEET # 2 OF 2
<small>CAD GENERATED DOCUMENT. DO NOT MEASURE DRAWING.</small>			