



QPA2308D

5 – 6 GHz 60 Watt GaN Power Amplifier

Product Overview

Qorvo's QPA2308D is a MMIC power amplifier fabricated on Qorvo's production 0.25 μm GaN on SiC process (QgaN25). Operating from 5.0–6.0 GHz, the QPA2308D produces greater than 60 W of saturated output power and greater than 21 dB of large-signal gain while achieving greater than 43% power-added efficiency.

Both RF ports are fully matched to 50 ohms with integrated DC blocking capacitors thereby simplifying system integration. The QPA2308D's performance makes it well suited for both commercial and military applications.

Lead-free and RoHS compliant.

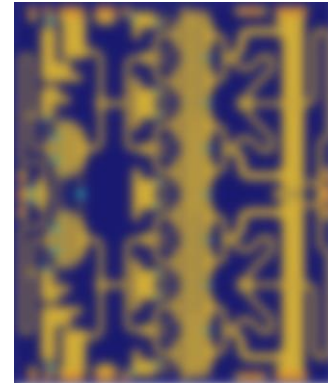

Key Features

- Frequency Range: 5.0–6.0 GHz
- P_{SAT} ($P_{IN}=26$ dBm): 47.8 dBm
- PAE ($P_{IN}=26$ dBm): 43 %
- Power Gain ($P_{IN}=26$ dBm): 21 dB
- Small Signal Gain: 31 dB
- Bias (pulsed): $V_D = 28$ V, $I_{DQ} = 1200$ mA
- Die Dimensions: 4.272 x 5.070 x 0.10 mm

Performance is typical across frequency. Please reference electrical specification table and data plots for more details.

Functional Block Diagram

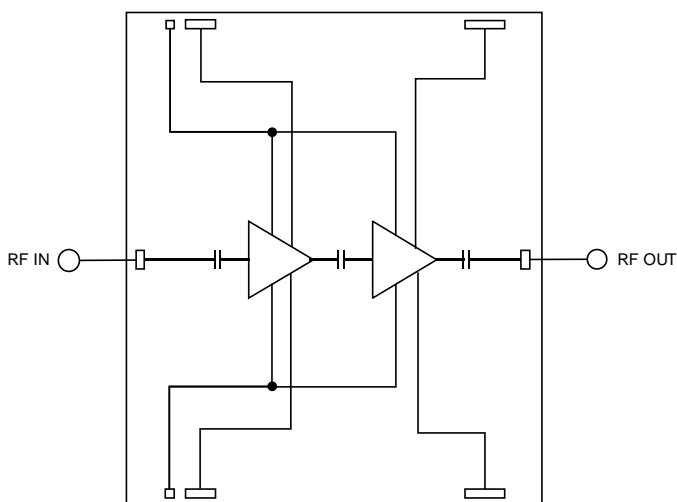

Applications

- C-Band Radar
- Satellite Communications

Ordering Information

Part No.	Description
QPA2308D	5-6 GHz 60 Watt GaN Power Amplifier
QPA2308DS2	Samples (2 pcs.)
QPA2308DEVB02	Evaluation Board for QPA2308D

Absolute Maximum Ratings

Parameter	Value / Range
Drain Voltage (V_D)	40 V
Gate Voltage Range (V_G)	-5 V to +1 V
Drain Current (I_D)	7600 mA
Gate Current (I_G)	See plot pg.12
Power Dissipation, CW, 85 °C	140 W
Input Power (P_{IN}), 50 Ω , $V_D=28$ V, $I_{DQ}=1.2$ A, 85 °C	32 dBm
Input Power (P_{IN}), 3:1 VSWR, $V_D=28$ V, $I_{DQ}=1.2$ A, 85 °C	32 dBm
Soldering Temperature (3 – 4 minutes, maximum)	320 °C
Storage Temperature	-55 to +125 °C

Operation of this device outside the parameter ranges given above may cause permanent damage. These are stress ratings only, and functional operation of the device at these conditions is not implied.

Recommended Operating Conditions

Parameter	Value / Range
Drain Voltage (V_D)	28 V
Drain Current (I_{DQ})	1200 mA
Operating Temperature	-40 to +85 °C

Electrical specifications are measured at specified test conditions. Specifications are not guaranteed over all recommended operating conditions.

Electrical Specifications

Parameter		Min	Typ	Max	Units
Operational Frequency		5		6	GHz
Output Power (P _{IN} =26 dBm)	5.0 GHz		48.0		dBm
	5.5 GHz		47.7		dBm
	6.0 GHz		47.4		dBm
Power Added Efficiency (P _{IN} =26 dBm)	5.0 GHz		43.6		%
	5.5 GHz		48.0		%
	6.0 GHz		51.5		%
Small Signal Gain	5.0 GHz		30.8		dB
	5.5 GHz		32.3		dB
	6.0 GHz		30.3		dB
Input Return Loss	5.0 GHz		27		dB
	5.5 GHz		11		dB
	6.0 GHz		11		dB
Output Return Loss	5.0 GHz		12		dB
	5.5 GHz		13		dB
	6.0 GHz		12		dB
Second Harmonic (P _{OUT} =45 dBm, Freq.=5.5 GHz)			-39		dBc
Third Harmonic (P _{OUT} =45 dBm, Freq.=5.5 GHz)			-60		dBc
P _{OUT} Temp. Coeff. (85 °C to 25 °C, P _{IN} = 26 dBm))			-0.003		dB/°C
Sm. Sig. Gain Temp. Coefficient (85 °C to -40 °C)			-0.046		dB/°C

Test conditions, unless otherwise noted: T = 25 °C, V_D = 28 V, I_{DQ} = 1200 mA, PW = 600 us, Duty Cycle = 20%

Performance Plots – Large Signal

Test conditions, unless otherwise noted: $V_D = 28\text{ V}$, $I_{DQ} = 1200\text{ mA}$, $T = +25\text{ }^\circ\text{C}$, $P_{IN} = 26\text{ dBm}$, $PW = 600\text{ }\mu\text{s}$, Duty Cycle = 20%

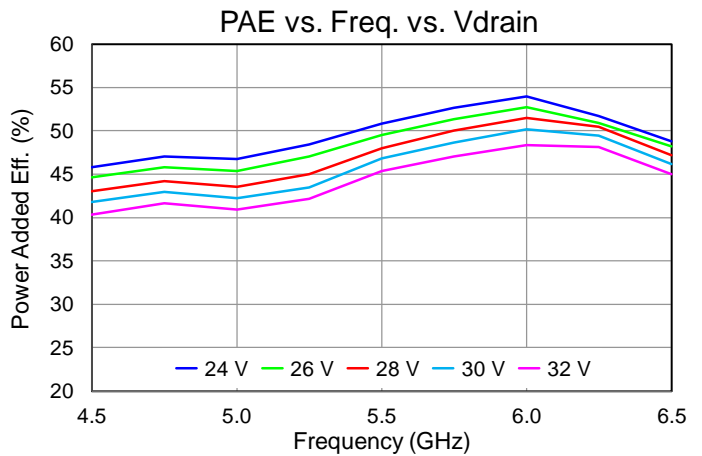
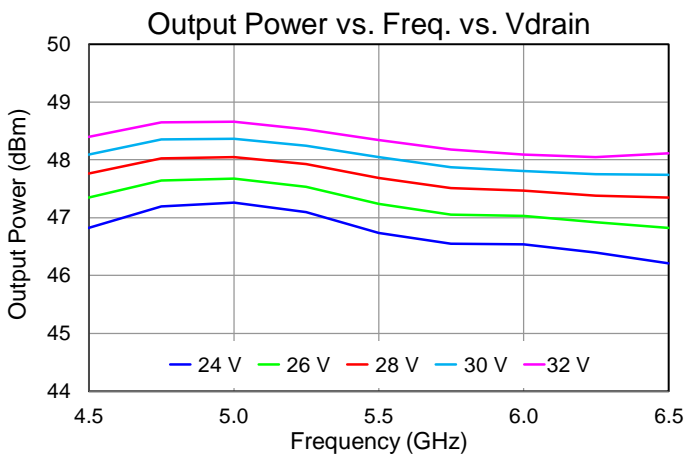
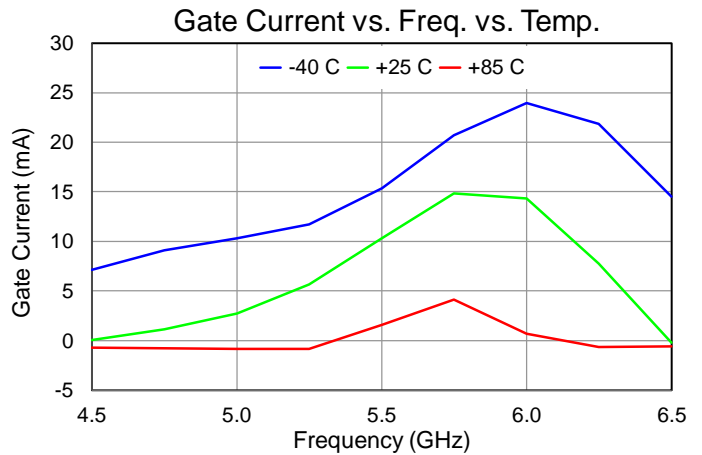
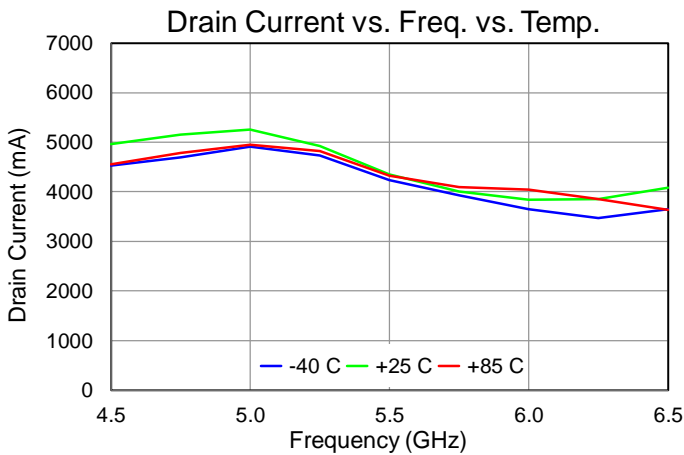
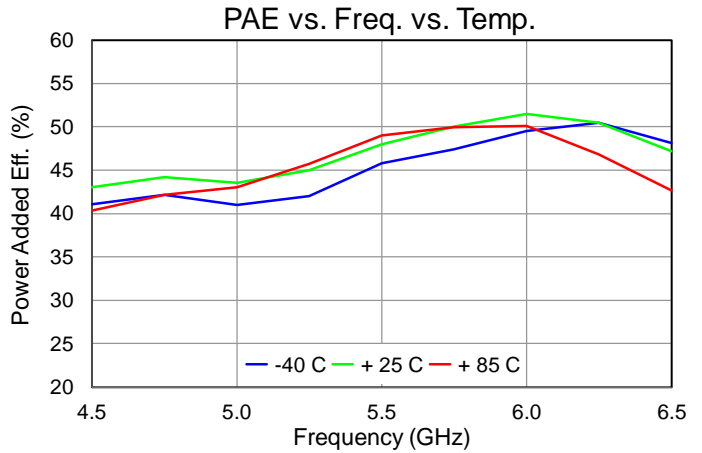
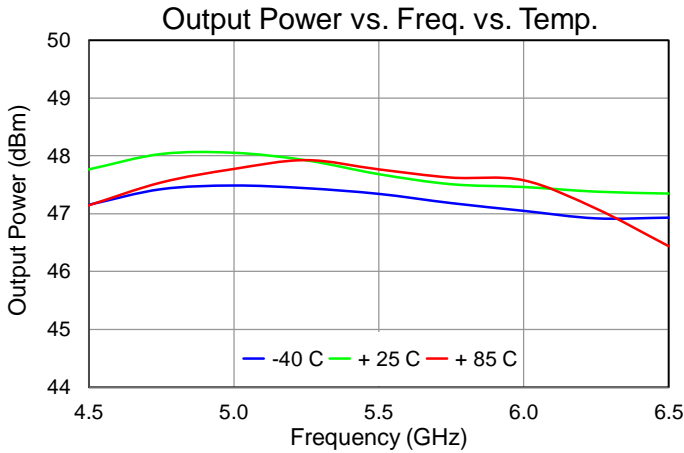

Performance Plots – Large Signal

Test conditions, unless otherwise noted: $V_D = 28\text{ V}$, $I_{DQ} = 1200\text{ mA}$, $T = +25^\circ\text{C}$, $P_{IN} = 26\text{ dBm}$, $PW = 600\text{ }\mu\text{s}$, Duty Cycle = 20%

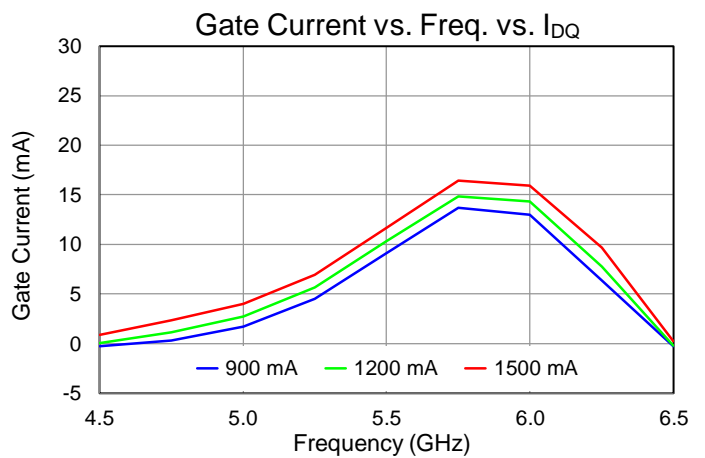
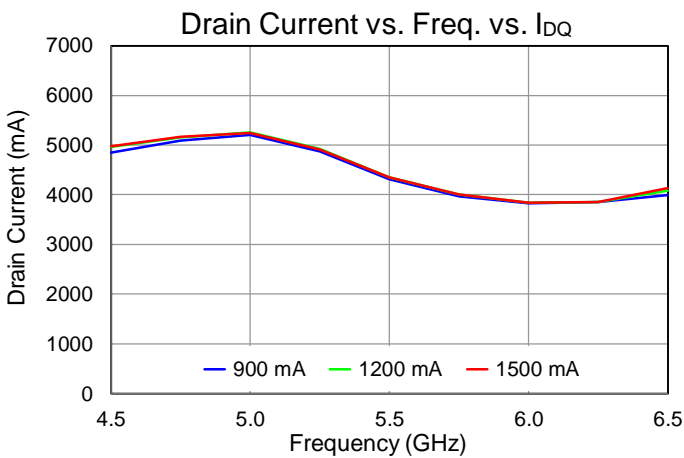
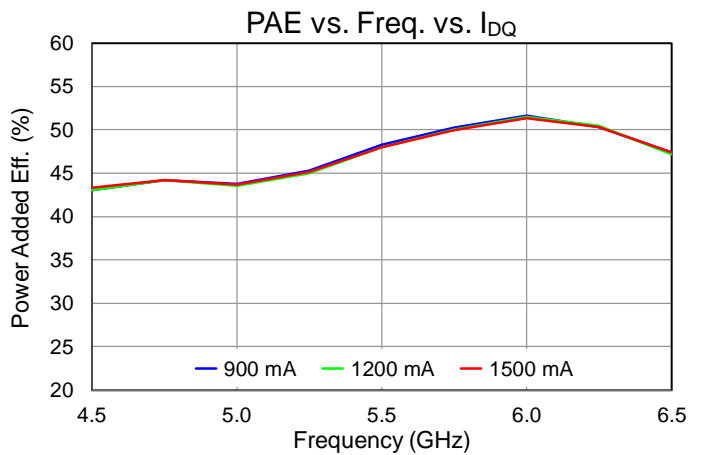
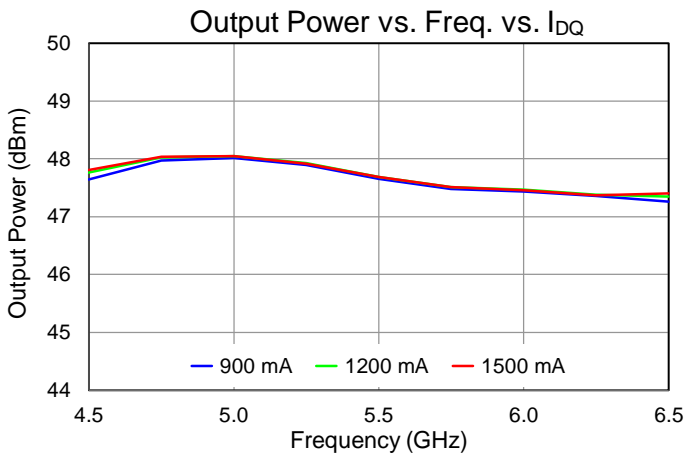
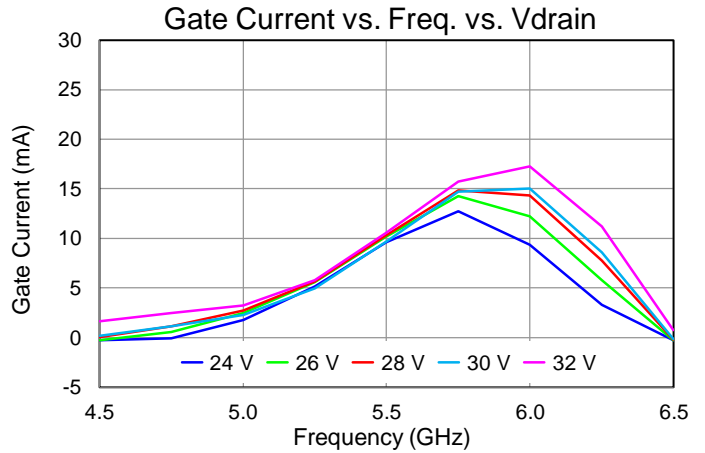
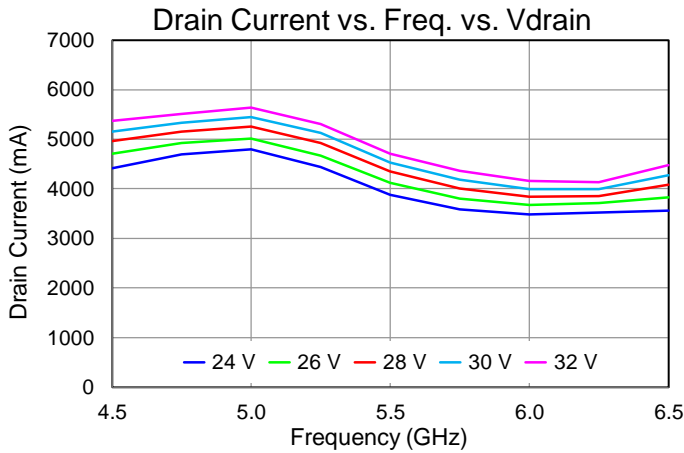

Performance Plots – Large Signal

Test conditions, unless otherwise noted: $V_D = 28\text{ V}$, $I_{DQ} = 1200\text{ mA}$, $T = +25\text{ }^\circ\text{C}$, $PW = 600\text{ }\mu\text{s}$, Duty Cycle = 20%

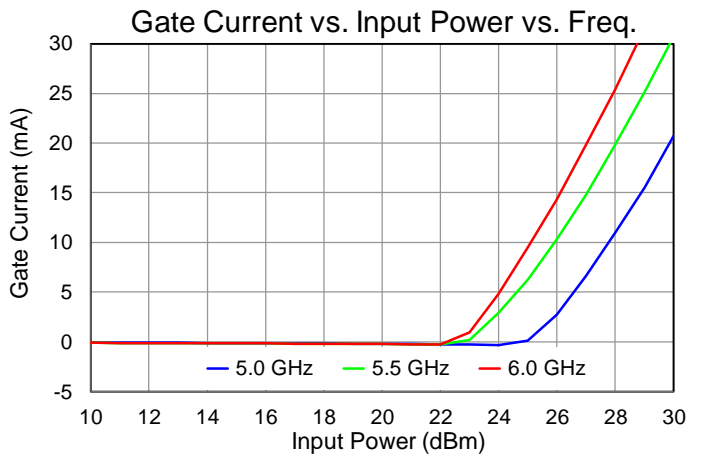
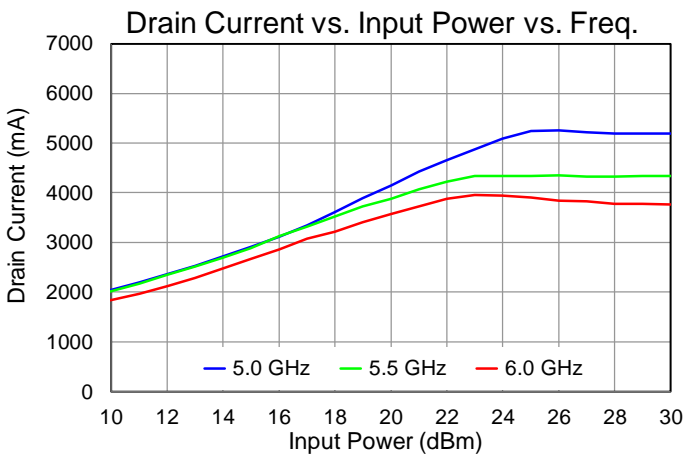
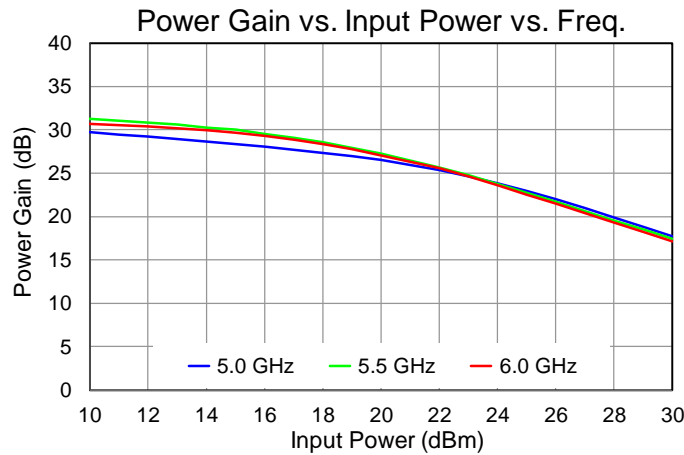
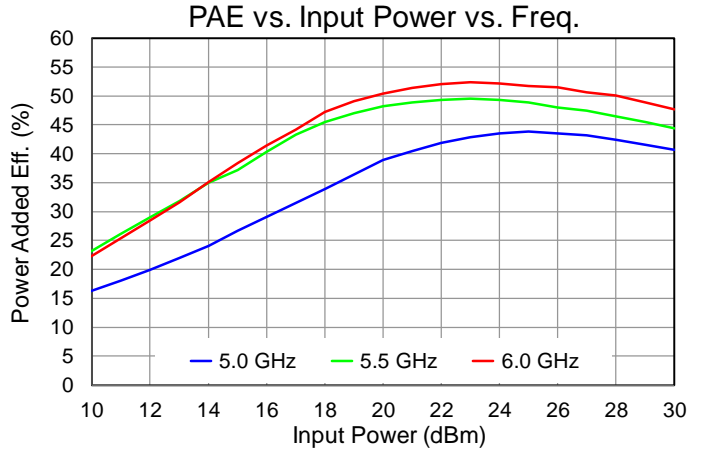
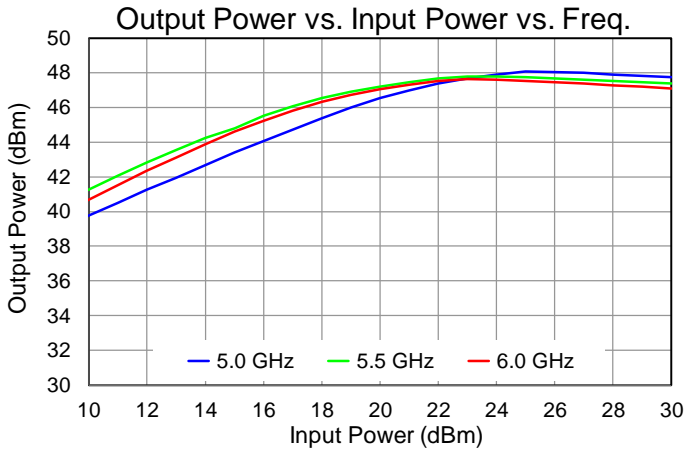

Performance Plots – Large Signal

Test conditions, unless otherwise noted: $V_D = 28\text{ V}$, $I_{DQ} = 1200\text{ mA}$, $T = +25\text{ }^\circ\text{C}$, $PW = 600\text{ }\mu\text{s}$, Duty Cycle = 20%

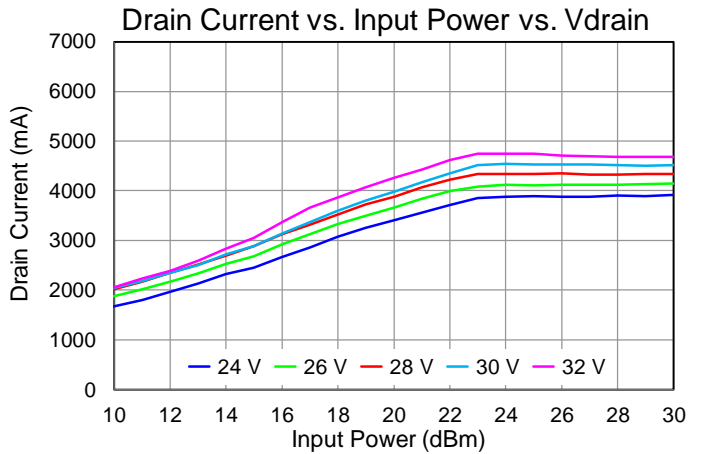
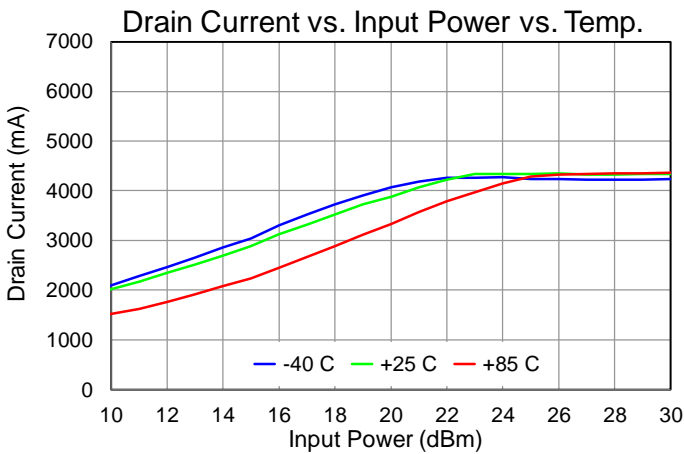
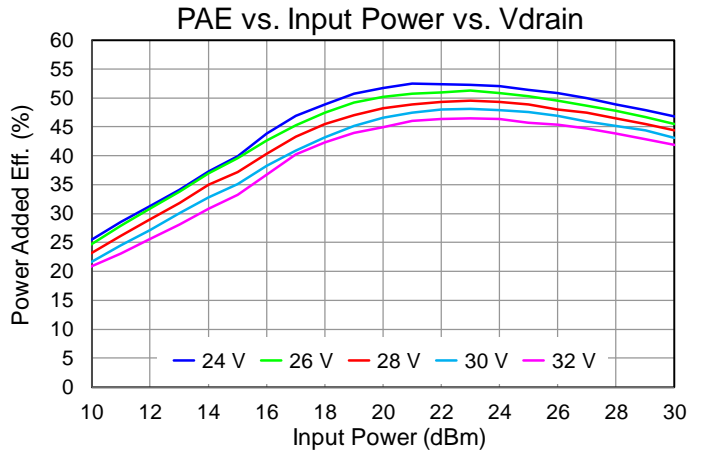
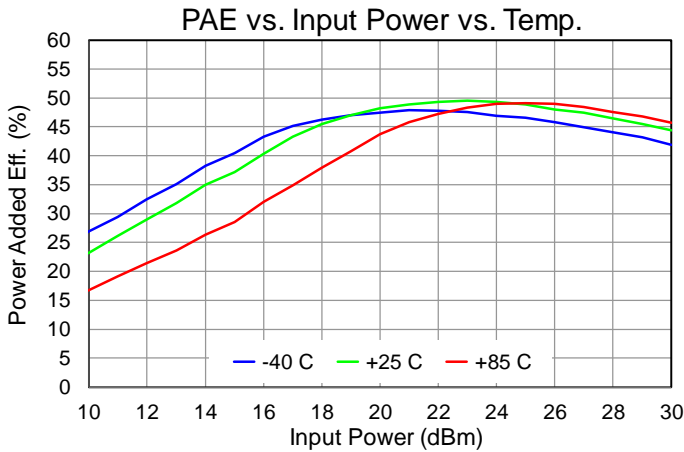
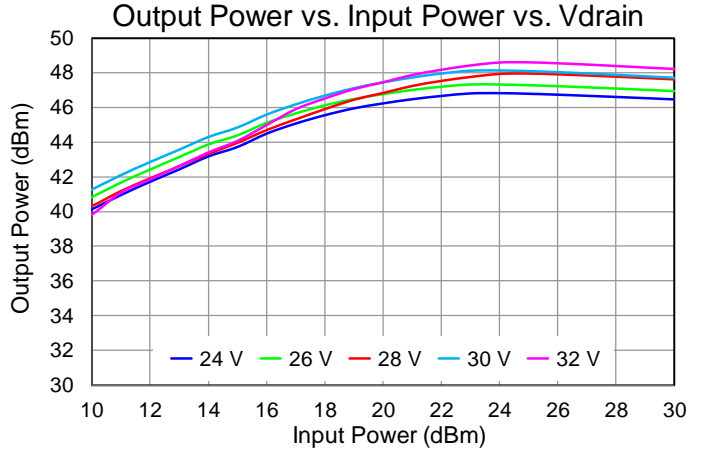
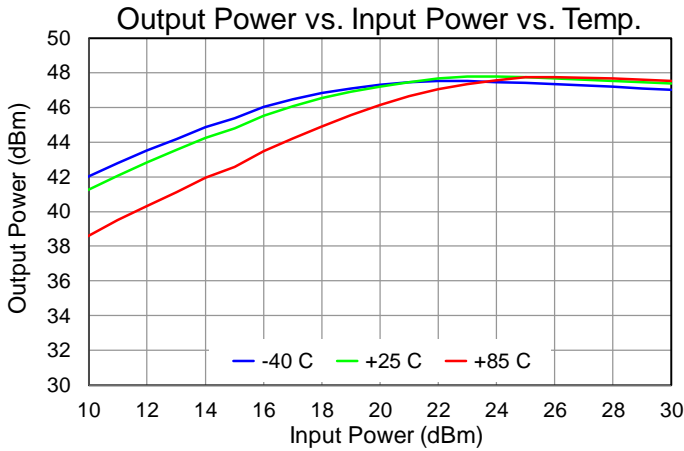

Performance Plots – Large Signal

Test conditions, unless otherwise noted: $V_D = 28\text{ V}$, $I_{DQ} = 1200\text{ mA}$, $T = +25\text{ }^\circ\text{C}$, $PW = 600\text{ }\mu\text{s}$, Duty Cycle = 20%

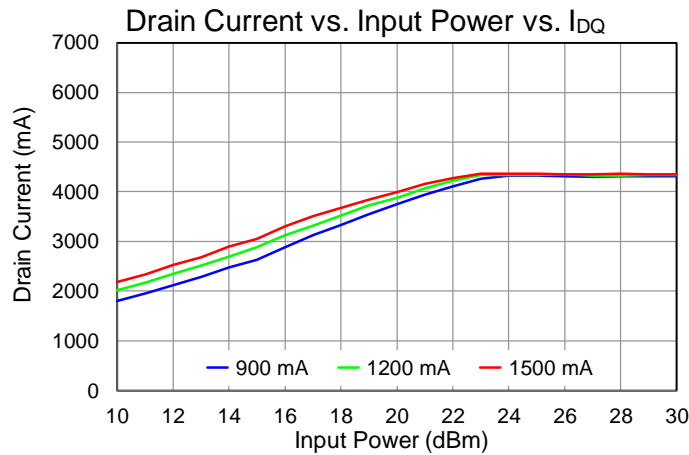
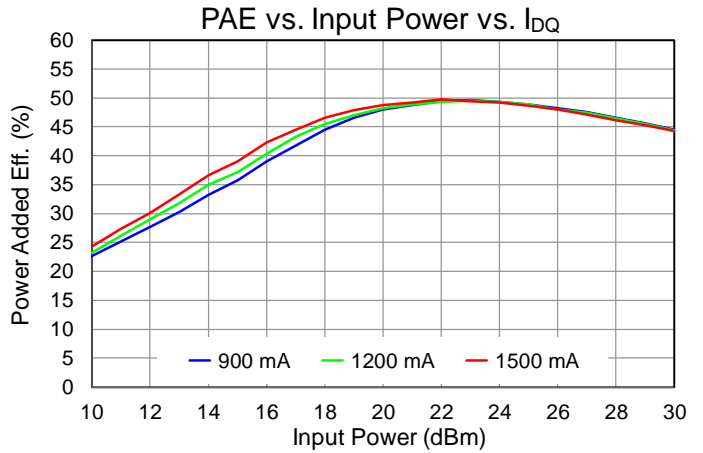
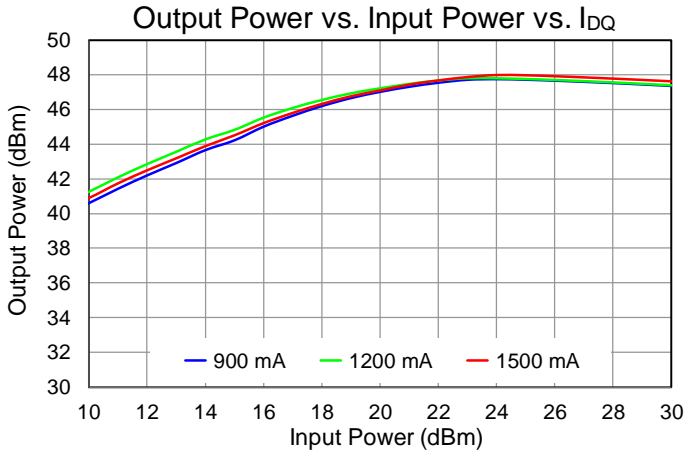

Performance Plots – Harmonics

Test conditions, unless otherwise noted: $V_D = 28\text{ V}$, $I_{DQ} = 1200\text{ mA}$, $T = +25\text{ }^\circ\text{C}$, $PW = 600\text{ }\mu\text{s}$, Duty Cycle = 20%

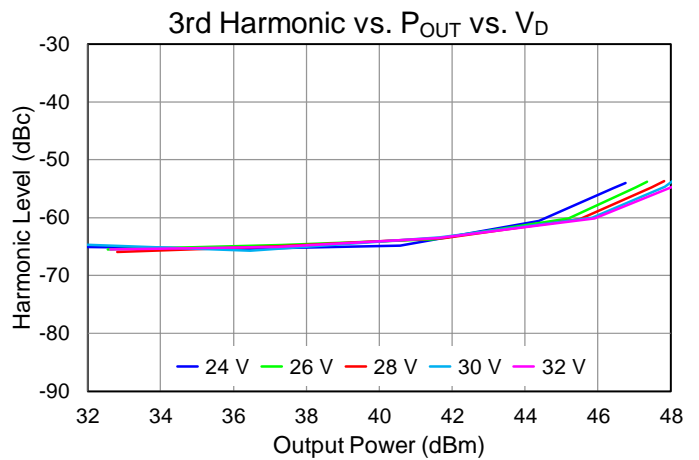
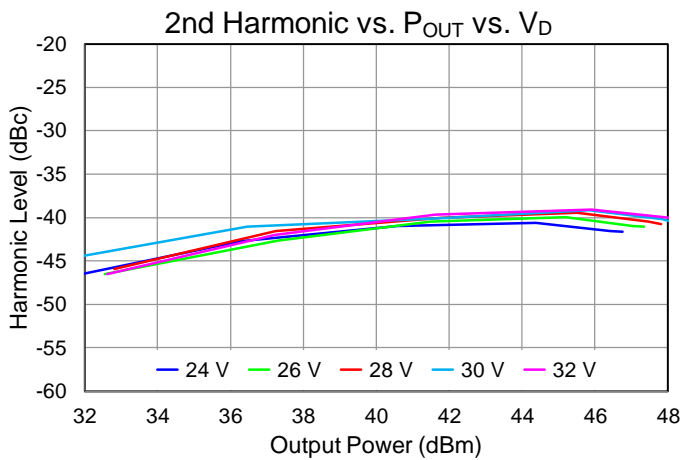
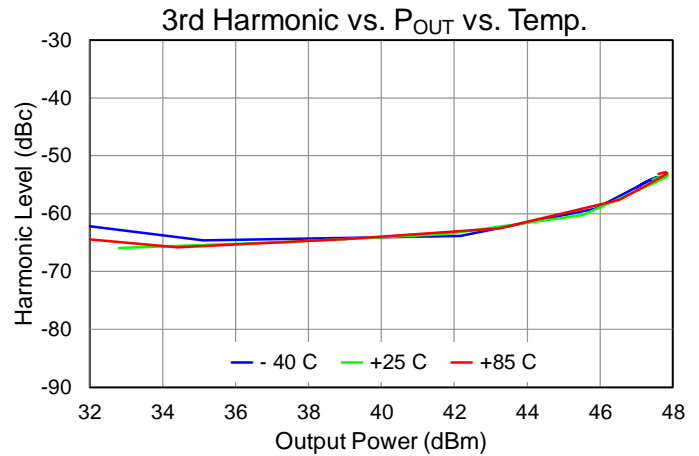
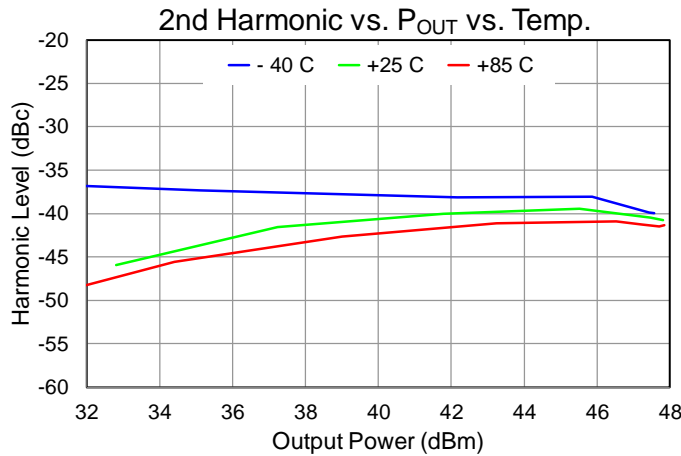
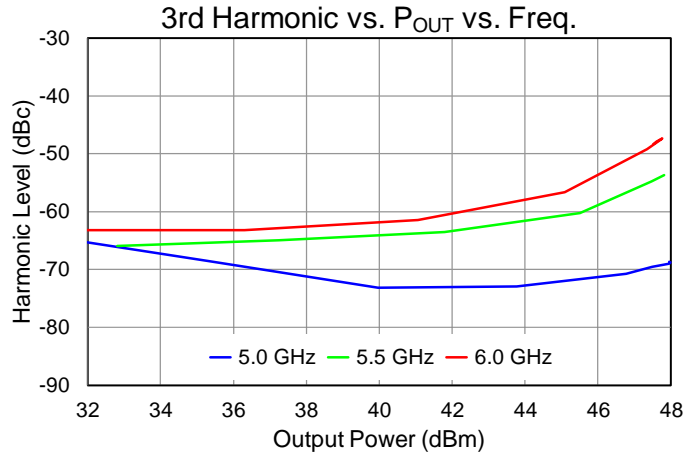
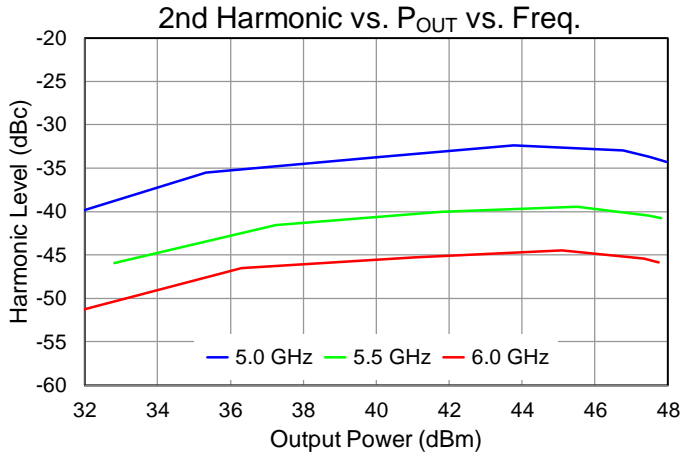

Performance Plots – Small Signal

Test conditions, unless otherwise noted: $V_D = 28\text{ V}$, $I_{DQ} = 1200\text{ mA}$, $T = +25\text{ }^\circ\text{C}$

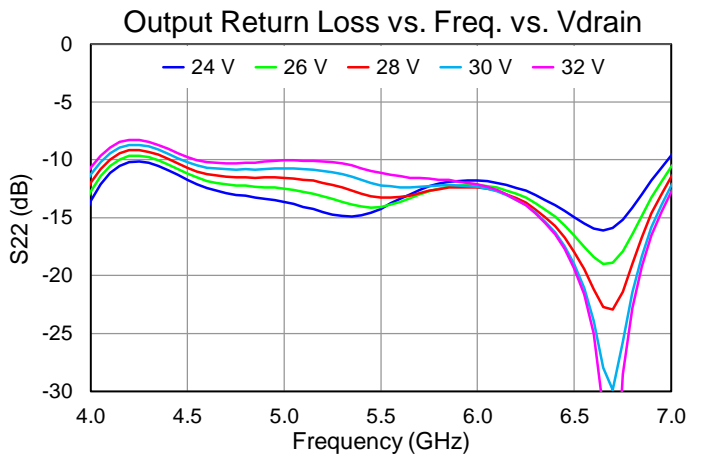
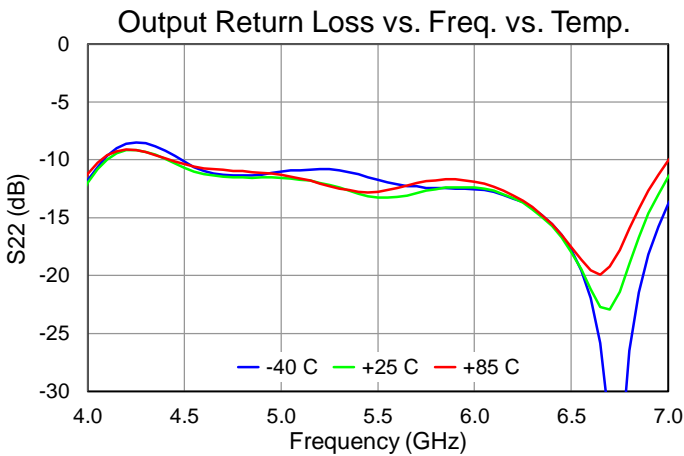
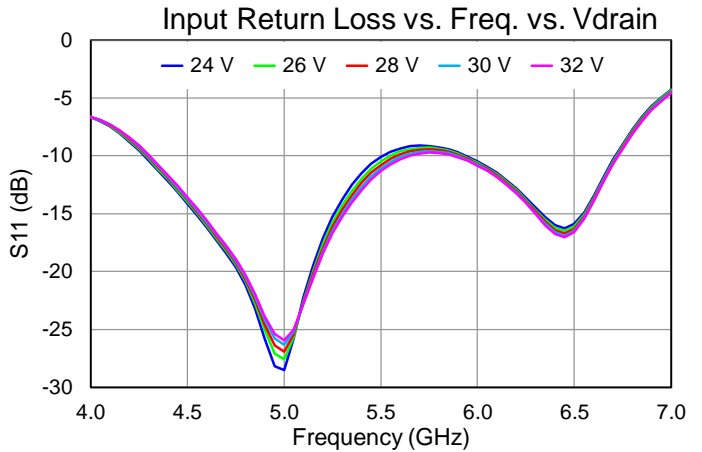
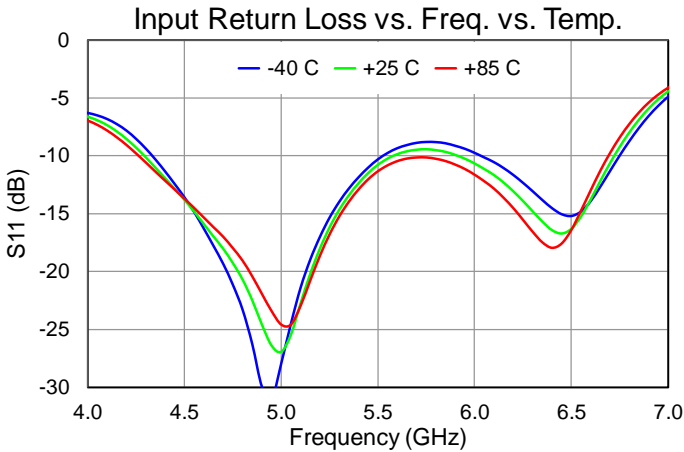
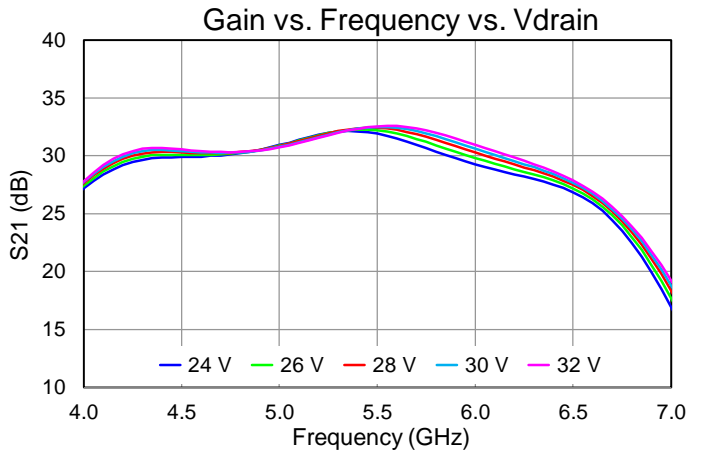
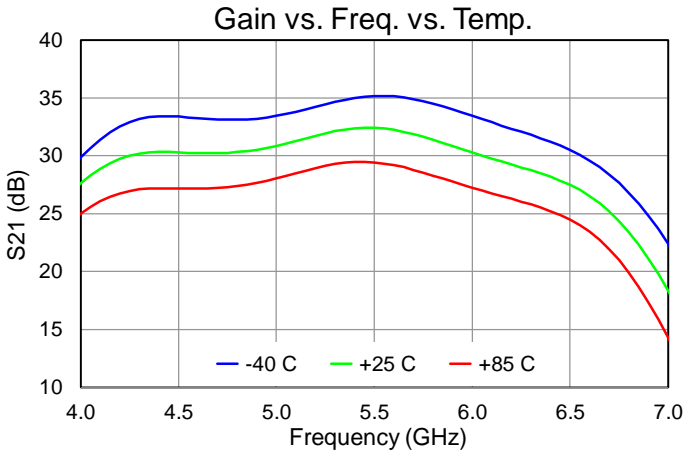

Performance Plots – Small Signal

Test conditions, unless otherwise noted: $V_D = 28\text{ V}$, $I_{DQ} = 1200\text{ mA}$, $T = +25\text{ }^\circ\text{C}$

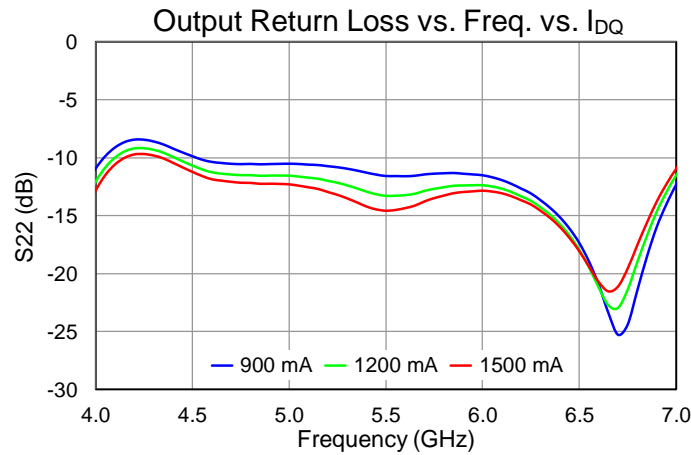
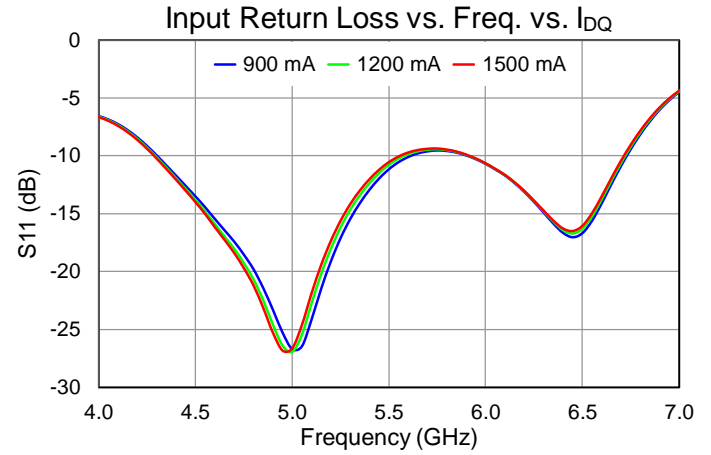
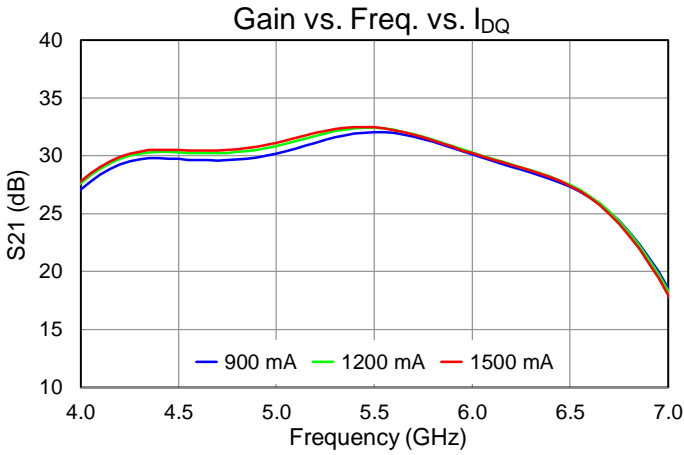

Thermal and Reliability Information

Parameter	Test Conditions	Value	Units
Thermal Resistance (θ_{JC}) ⁽¹⁾	T _{base} = 85 °C, V _D = 28 V, I _{DQ} = 1200 mA, P _{DISS} = 33.6 W, No RF (quiescent DC operation)	0.92	°C/W
Channel Temperature, T _{CH} (Under RF) ⁽²⁾		104.3	°C
Thermal Resistance (θ_{JC}) ⁽¹⁾	T _{base} = 85 °C, V _D = 28 V, I _{DQ} = 1200 mA, Freq = 5.0 GHz, I _{D_Drive} = 4.95 A, P _{IN} = 26 dBm, P _{OUT} = 47.8 dBm, P _{DISS} = 78.7 W	0.653	°C/W
Channel Temperature, T _{CH} (Under RF) ⁽²⁾		136.4	°C
Thermal Resistance (θ_{JC}) ⁽¹⁾	T _{base} = 85 °C, V _D = 32 V, I _{DQ} = 1200 mA, Freq = 5.0 GHz, I _{D_Drive} = 5.20 A, P _{IN} = 26 dBm, P _{OUT} = 48.2 dBm, P _{DISS} = 99.2 W	0.671	°C/W
Channel Temperature, T _{CH} (Under RF) ⁽²⁾		151.6	°C

Notes:

1. Thermal resistance is referenced to the back of the 20 mil Cu-Mo carrier plate mount (85 °C)
2. Refer to the following document: [GaN Device Channel Temperature, Thermal Resistance, and Reliability Estimates](#)

Dissipated Power and Maximum Gate Current

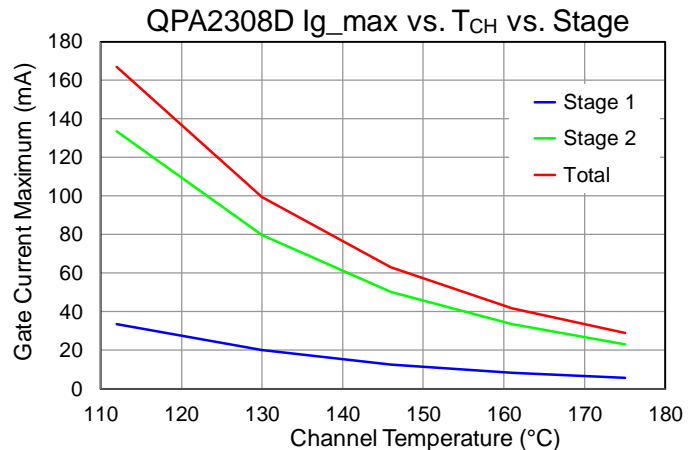
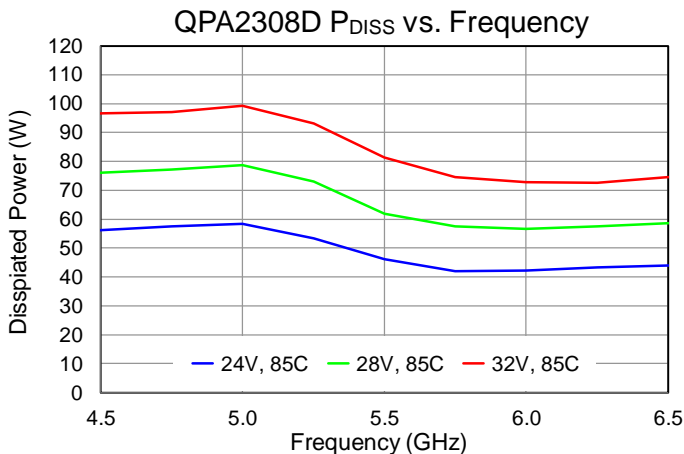

Test conditions, unless otherwise noted: V_D = 28 V, I_{DQ} = 1200 mA, P_{IN}=26 dBm, PW = 600 us, Duty Cycle = 20%

Applications Information

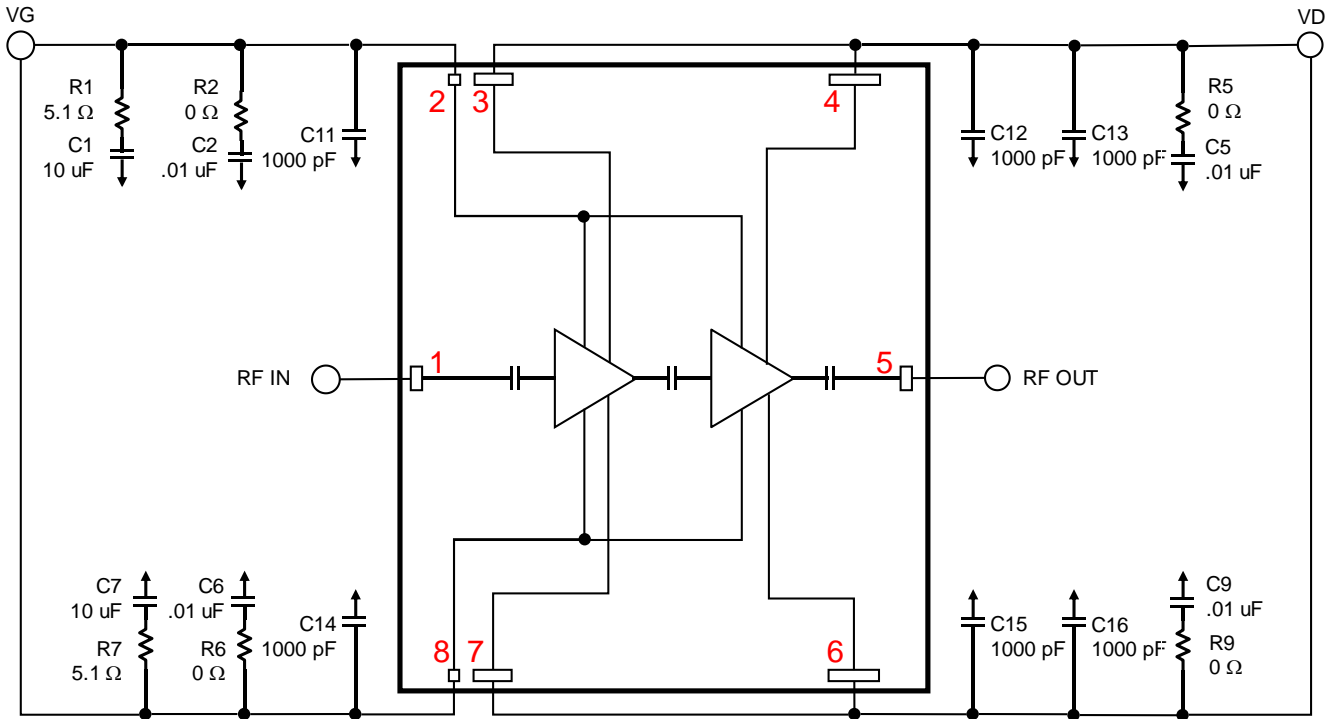

Note: Vg and Vd should be provided on both sides of the die.

Bias-Up Procedure

1. Set I_D limit to 5500 mA, I_G limit to 30 mA
2. Set V_G to -5.0 V
3. Set V_D +28 V
4. Adjust V_G more positive until $I_{DQ} \approx 1200$ mA
5. Apply RF signal

Bias-Down Procedure

1. Turn off RF signal
2. Reduce V_G to -5.0 V. Ensure $I_{DQ} \sim 0$ mA
4. Set V_D to 0 V
5. Turn off V_D supply
6. Turn off V_G supply

Evaluation Board (EVB) Layout Assembly

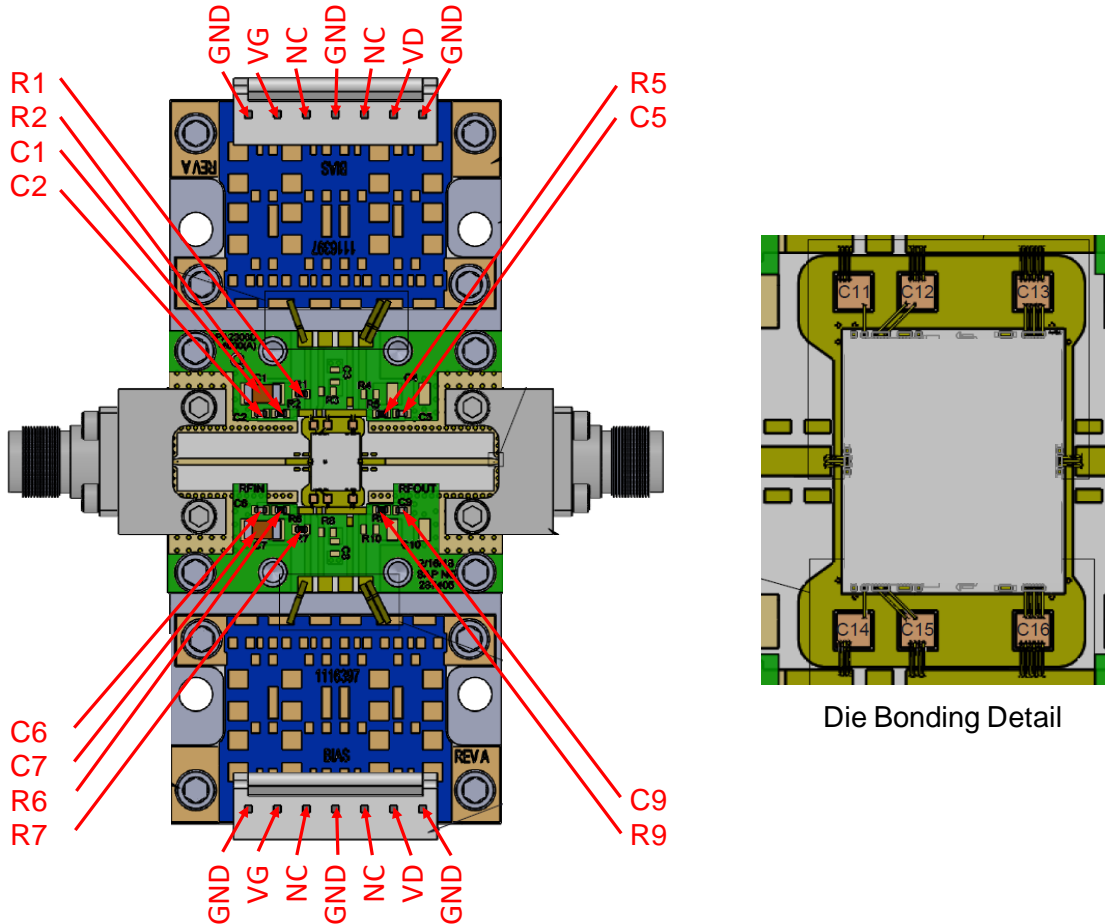

PCB is made from Rogers 4003C dielectric, .008 inch thick, 0.5 oz. copper both sides.

Bill of Materials

Reference Des.	Value	Description	Manuf.	Part Number
C1, C7	10 uF	CAP, 10 uF, 20%, 50 V, 20%, X5R, 1206	Various	
C2, C5, C6, C9	0.01 uF	CAP, 0.01 uF, 10%, 50 V, X7R, 0402	Various	
C11, C12, C13, C14, C15, C16	1000 pF	CAP, 10000pF, 20%, 100V, X7R, 30X30, SL	Various	
R1, R7	5.1 Ω	RES, 5.1 OHM, 5%, 50 V, 0402	Various	
R2, R5, R6, R9	0 Ω	RES, 0 OHM, JMPR, 0402	Various	
J1, J2	2.92 mm	CONNECTOR, FEMALE, ENDLAUNCH	Southwest Microwave	1092-01A-5

Mechanical Information

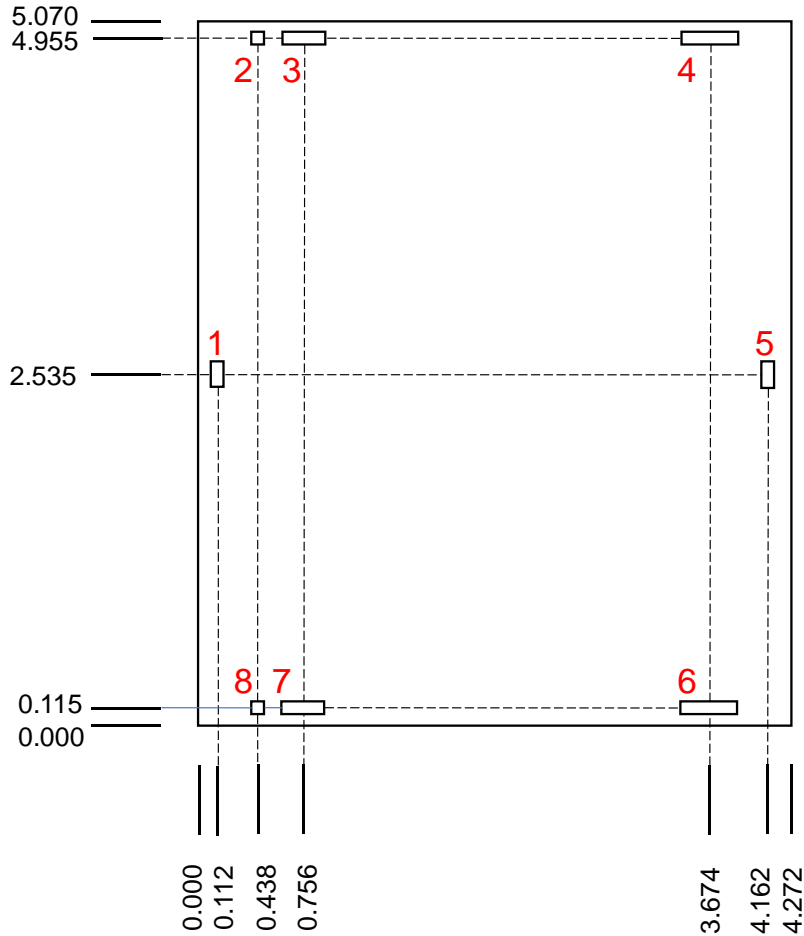

Dimensions are in mm
Thickness: 0.100
Die x, y size tolerance: ± 0.050
Ground is backside of die

Bond Pad Description

Pad No.	Symbol	Description	Pad Size (um x um)
1	RF IN	RF input. 50 Ohms. DC blocked.	90 x 190
2, 8	VG	Gate voltage (both stages). Bypass network required; see page 13.	90 x 90
3, 7	VD1	Drain voltage stage 1. Bypass network required; see page 13.	308 x 90
4, 6	VD2	Drain voltage stage 2. Bypass network required; see page 13.	408 x 90
5	RF OUT	RF output. 50 Ohms. DC blocked.	90 x 190

Assembly Notes

Component placement and adhesive attachment assembly notes:

- Vacuum pencils and/or vacuum collets are the preferred method of pick up.
- Air bridges must be avoided during placement.
- The force impact is critical during auto placement.

Reflow process assembly notes:

- Use AuSn (80/20) solder and limit exposure to temperatures above 300 °C to 3–4 minutes, maximum.
- An alloy station or conveyor furnace with reducing atmosphere should be used.
- Do not use any kind of flux.
- Coefficient of thermal expansion matching is critical for long-term reliability.
- Devices must be stored in a dry nitrogen atmosphere.

Interconnect process assembly notes:

- Thermosonic ball bonding is the preferred interconnect technique.
- Force, time, and ultrasonic are critical parameters.
- Aluminum wire should not be used.
- Devices with small pad sizes should be bonded with 0.0007-inch wire.

Handling Precautions

Parameter	Rating	Standard
ESD – Human Body Model (HBM)	1A	ANSI/ESD/JEDEC JS-001



Caution!
 ESD-Sensitive Device

Solderability

Use only AuSn (80/20) solder, and limit exposure to temperatures above 300 °C to 3–4 minutes, maximum.

RoHS Compliance

This part is compliant with 2011/65/EU RoHS directive (Restrictions on the Use of Certain Hazardous Substances in Electrical and Electronic Equipment) as amended by Directive 2015/863/EU.

This product also has the following attributes:

- Lead Free
- Halogen Free (Chlorine, Bromine)
- Antimony Free
- TBBP-A (C₁₅H₁₂Br₄O₂) Free
- PFOS Free
- SVHC Free

Contact Information

For the latest specifications, additional product information, worldwide sales and distribution locations:

Web: www.qorvo.com

Tel: 1-844-890-8163

Email: customer.support@qorvo.com

Important Notice

The information contained herein is believed to be reliable; however, Qorvo makes no warranties regarding the information contained herein and assumes no responsibility or liability whatsoever for the use of the information contained herein. All information contained herein is subject to change without notice. Customers should obtain and verify the latest relevant information before placing orders for Qorvo products. The information contained herein or any use of such information does not grant, explicitly or implicitly, to any party any patent rights, licenses, or any other intellectual property rights, whether with regard to such information itself or anything described by such information. **THIS INFORMATION DOES NOT CONSTITUTE A WARRANTY WITH RESPECT TO THE PRODUCTS DESCRIBED HEREIN, AND QORVO HEREBY DISCLAIMS ANY AND ALL WARRANTIES WITH RESPECT TO SUCH PRODUCTS WHETHER EXPRESS OR IMPLIED BY LAW, COURSE OF DEALING, COURSE OF PERFORMANCE, USAGE OF TRADE OR OTHERWISE, INCLUDING THE IMPLIED WARRANTIES OF MERCHANTABILITY AND FITNESS FOR A PARTICULAR PURPOSE.**

Without limiting the generality of the foregoing, Qorvo products are not warranted or authorized for use as critical components in medical, life-saving, or life-sustaining applications, or other applications where a failure would reasonably be expected to cause severe personal injury or death.

Copyright 2019 © Qorvo, Inc. | Qorvo is a registered trademark of Qorvo, Inc.