

THIS DOCUMENT IS SUBJECT TO CHANGE WITHOUT NOTICE. IT IS CONFIDENTIAL AND A PROPERTY OF Amphenol LTW. DISCLOSURE TO THIRD PARTY HAS TO BE AUTHORIZED BY Amphenol LTW.

REV.	ECN NO.	DATE	SIGN	DESCRIPTION
C	LE313C0106	2013-12-16	Fisher	Change Plating and Package
D	CI91496	2019-08-29	NianPing Yu	Add UL Label
E	CI92063	2019-12-03	NianPing Yu	△E, XI

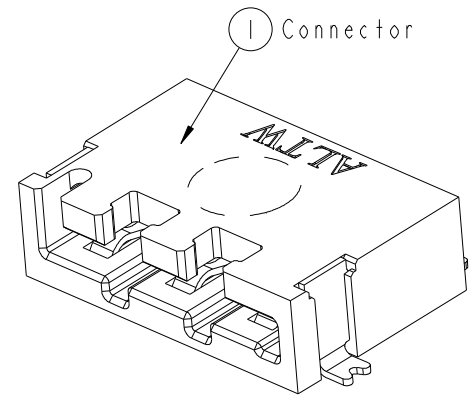

RECOMMENDED P.C.B. LAYOUT  
GENERAL TOLERANCE IS ±0.05

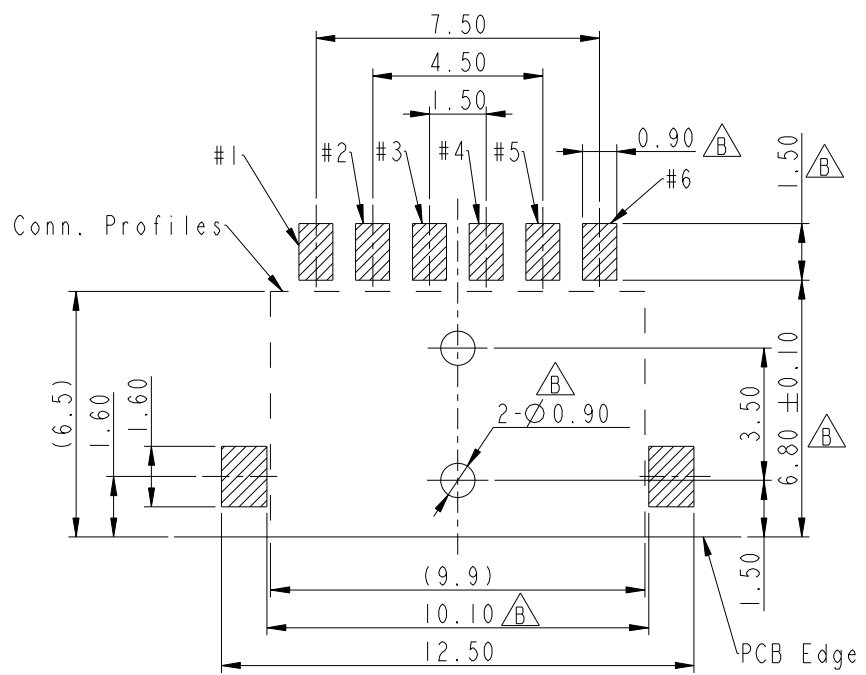
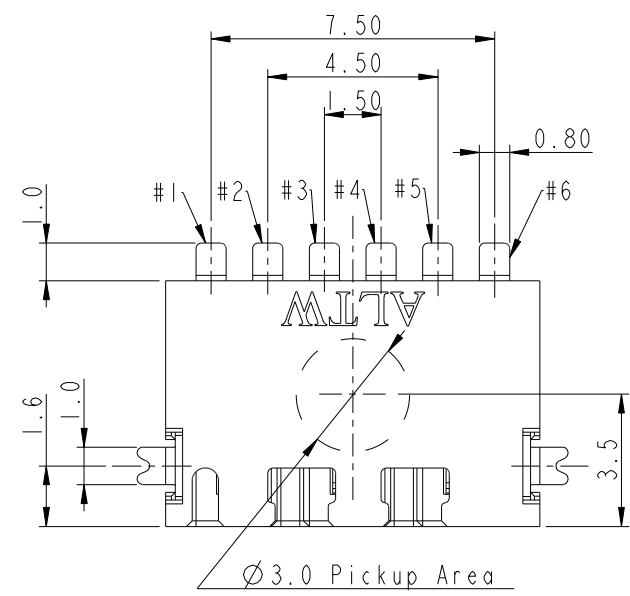
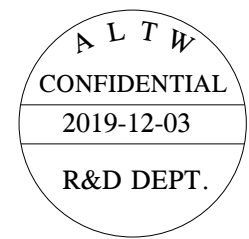
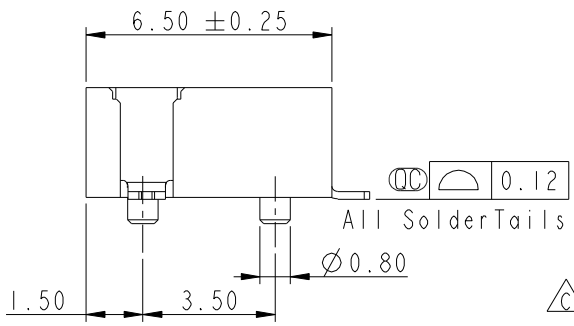
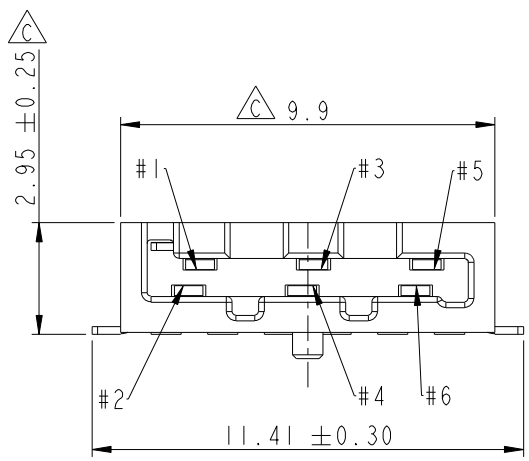

- Notes:
- \* Important Dimension To Check.
  - \* Housing: High temperature thermoplastic. UL94V-0, color is Natural white.
  - \* Terminal: Copper Alloy, Gold Plated on contact area. Tin plated on solder tails.
  - \* Solder Peg: Copper Alloy, Tin plated over Nickel.

UNIT: mm		
TOLERANCE		
.X	±0.25	
.XX	±0.1	
.XXX	±0.05	
ANGLES	±1°	

TITLE SSL-1.1 DC JACK CONNECTOR 6-POS. WITH POST, SMT TYPE			
SCALE	5:1	SIZE	A4
SHEET	1	OF	2
REV.	E	WC-REV.	C.3
QC: Inspection item			

**Amphenol LTW**  
安費諾亮泰企業股份有限公司

ITEM NO.	SSL11-J6C00-000001	DRAWN BY	NianPing Yu	DATE	2019-08-29
DWG NO.	SSL11-J6C00-000001	CHECKED BY	Fisher Wang	DATE	2019-08-29
CUSTOMER	ALTW	APPROVED BY	Max Yang	DATE	2019-08-29

THIS DOCUMENT IS SUBJECT TO CHANGE WITHOUT NOTICE. IT IS CONFIDENTIAL AND A PROPERTY OF Amphenol LTW. DISCLOSURE TO THIRD PARTY HAS TO BE AUTHORIZED BY Amphenol LTW.

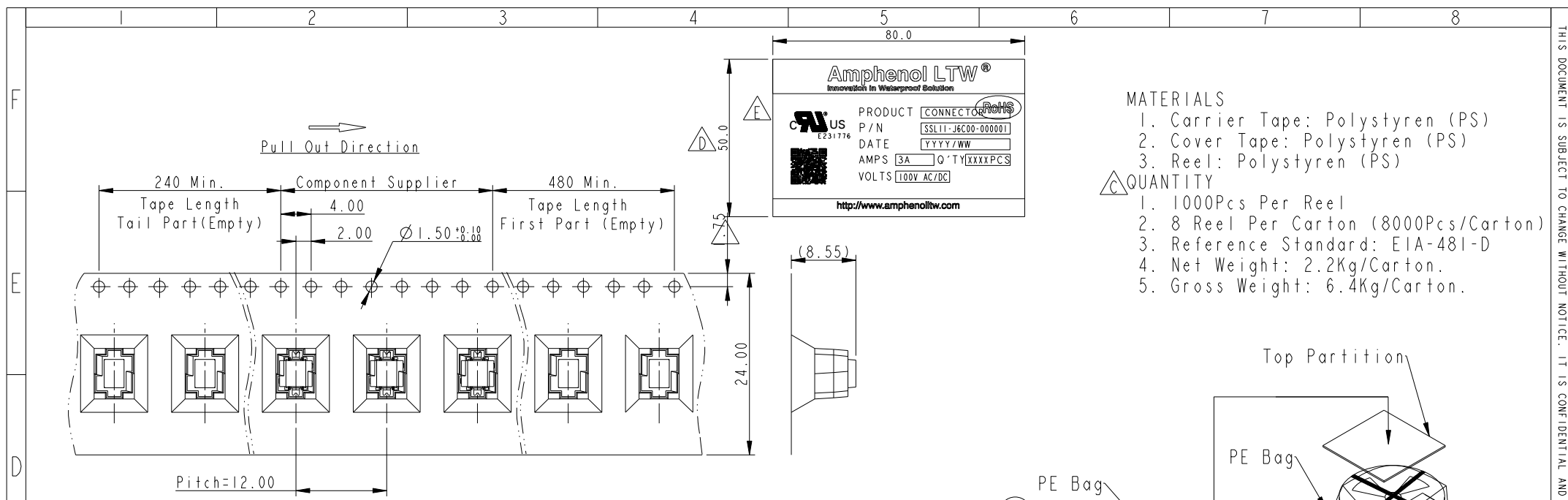

- MATERIALS**
- Carrier Tape: Polystyren (PS)
  - Cover Tape: Polystyren (PS)
  - Reel: Polystyren (PS)
- QUANTITY**
- 1000Pcs Per Reel
  - 8 Reel Per Carton (8000Pcs/Carton)
  - Reference Standard: EIA-481-D
  - Net Weight: 2.2Kg/Carton.
  - Gross Weight: 6.4Kg/Carton.

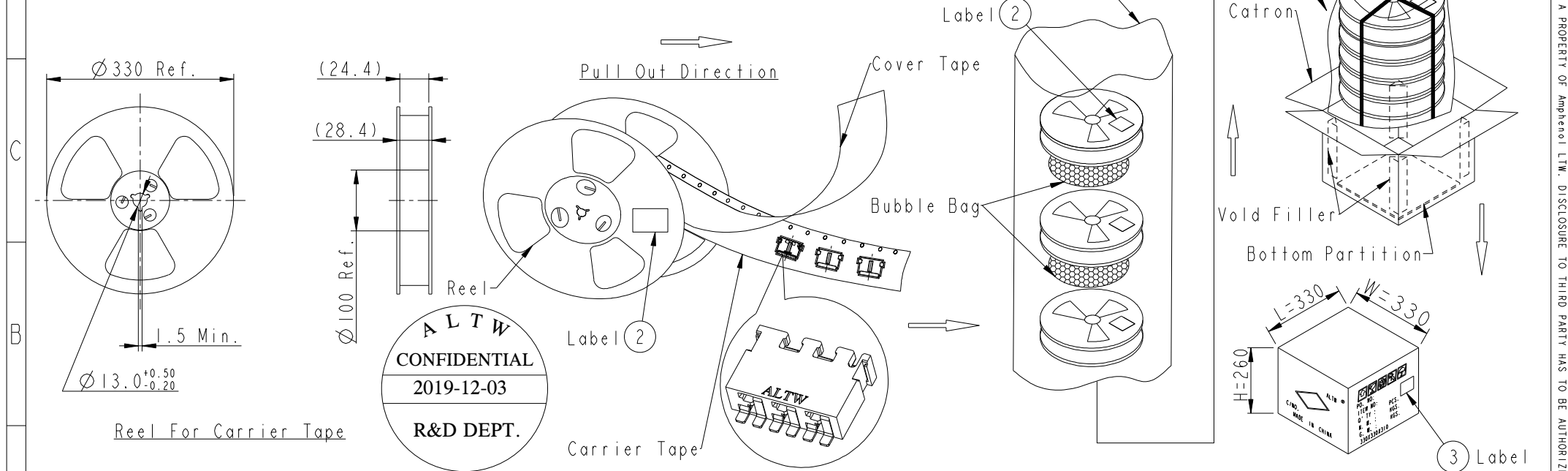

<b>UNIT:mm</b> TOLERANCE .X ±0.25 .XX ±0.1 .XXX ±0.05 ANGLES ±1°		<b>TITLE</b> SSL-1.1 DC JACK CONNECTOR 6-POS. WITH POST, SMT TYPE		<b>Amphenol LTW</b> 安費諾亮泰企業股份有限公司		<b>ITEM NO</b> SSL11-J6C00-000001	<b>DRAWN BY</b> NianPing Yu	<b>DATE</b> 2019-08-29
		<b>SCALE</b> 5:1	<b>SIZE</b> A4			<b>SHEET</b> 2 OF 2	<b>DWG NO</b> SSL11-J6C00-000001	<b>CHECKED BY</b> Fisher Wang
<b>REV.</b> E		<b>WC-REV.</b> C.3	Inspection item	<b>CUSTOMER</b> ALTW	<b>APPROVED BY</b> Max Yang	<b>DATE</b> 2019-08-29		