



mikromedia+

for STM32F7 ARM®

Amazingly compact, all-on-single-pcb development board carrying 4.3" TFT Touch Screen and lots of multimedia peripherals, all driven by powerful STM32F746ZG microcontroller from ARM® Cortex™-M7 family



TO OUR VALUED CUSTOMERS

I want to express my thanks to you for being interested in our products and for having confidence in MikroElektronika.

The primary aim of our company is to design and produce high quality electronic products and to constantly improve the performance thereof in order to better suit your needs.

A white handwritten signature in cursive script, appearing to read 'N. Matic', is positioned on the right side of the page.

Nebojsa Matic
General Manager

Table of Contents

Introduction to mikromedia+ for STM32F7 ARM®	4	4. RTC Battery and Reset Button	18
System Specification	4	5. Crystal oscillator and 2.048V reference	20
Package Contains	5	6. MicroSD Card Slot	22
1. Power supply	6	7. Touch Screen	24
2. STM32F746ZG microcontroller	8	8. Audio Module	26
Key microcontroller features	8	9. USB DEVICE connection	28
3. Programming the microcontroller	9	10. USB HOST connection	30
Programming with mikroBootloader	10	11. Accelerometer	32
step 1 - Connecting mikromedia	10	12. Flash Memory	34
step 2 - Browsing for .HEX file	11	13. RF transceiver	36
step 3 - Selecting .HEX file	11	14. Ethernet transceiver	38
step 4 - Uploading .HEX file	12	15. Buzzer	40
step 5 - Finish upload	13	16. Other modules	42
Programming with mikroProg™ programmer	14	17. Pads	44
mikroProg™ suite™ for ARM® software	16	18. mikromedia+ accessories	46
Software installation wizard	17	19. What's next	48

Introduction to mikromedia+ for STM32F7 ARM®

The **mikromedia+ for STM32F7 ARM®** is a compact development system with lots of on-board peripherals which allow development of devices with multimedia contents. The central part of the system is a 32-bit **ARM® Cortex™-M7 STM32F746ZG** 144-pin microcontroller. The mikromedia+ for STM32F7 ARM® features integrated modules such as stereo MP3 codec, **4.3" TFT 480x272** touch screen display, accelerometer, microSD card slot, buzzer, IR receiver, RGB LED diode, PIN photodiode, temperature sensor, 2.4GHz RF transceiver, Ethernet transceiver, 8 Mbit flash memory, RTC battery, Li-Polimer battery charger etc. The board also contains MINI-B USB connector, power screw terminals, 2x5 JTAG connector, two 1x26 connection pads, ON/OFF switch and other. It comes pre-programmed with USB HID bootloader, but can also be programmed with external programmers, such as **mikroProg™ for STM32** or ST-LINK programmer. Mikromedia is compact and slim, and perfectly fits in the palm of your hand, which makes it a convenient platform for mobile and other multimedia devices. We have also prepared a **mikromedia+ SHIELD for STM32 ARM®** extension board which enables you to easily expand the functionality of your board.

System Specification



power supply

Via USB cable (5V DC) or via screw terminals (5-12V DC)



power consumption

38 mA with erased MCU
(when on-board modules are inactive)



board dimensions

119.54 x 78 mm (4.71 x 3.07 inch)



weight

~112 g (0.247 lbs)

Package Contains



- 01 Damage resistant protective box



- 02 mikromedia+ for STM32F7 ARM® development system

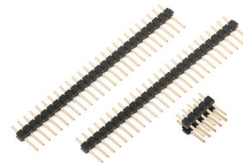

- 03 Two 1x26 male headers and one 2x5 header



- 04 mikromedia+ for STM32F7 ARM® user's guide



- 05 mikromedia+ for STM32F7 ARM® schematic



- 06 USB cable and microSD card

1. Power supply

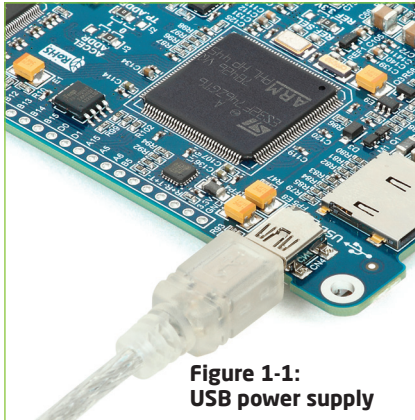

Figure 1-1:
USB power supply

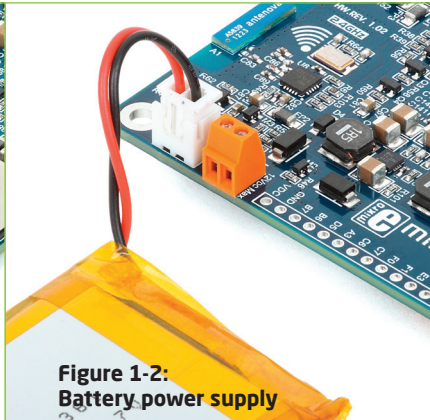

Figure 1-2:
Battery power supply

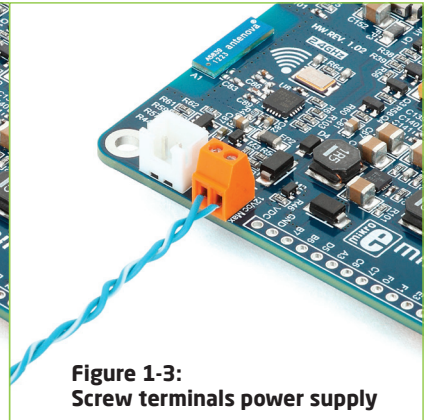

Figure 1-3:
Screw terminals power supply

The mikromedia+ for STM32F7 ARM® board can be powered in three different ways: via USB connector using MINI-B USB cable provided with the board (**CN4**), via battery connector using Li-Polymer battery (**CN5**) or via screw terminals using laboratory power supply (**CN3**). After you plug in the appropriate power supply turn the power switch ON (**SW1**). The USB connection can provide up to 500mA of current which is more than enough for the operation of all on-board modules and the microcontroller as well. If you decide to use external power supply via screw terminals, voltage values must be within **2.5-12V DC** range. Power **LED ON (GREEN)** indicates the presence of power supply. On-board battery charger circuit **MCP73832** enables you to charge the battery over USB connection or via screw terminals. **LED diode (RED)** indicates when battery is charging. Charging current is ~250mA and charging voltage is 4.2V DC.

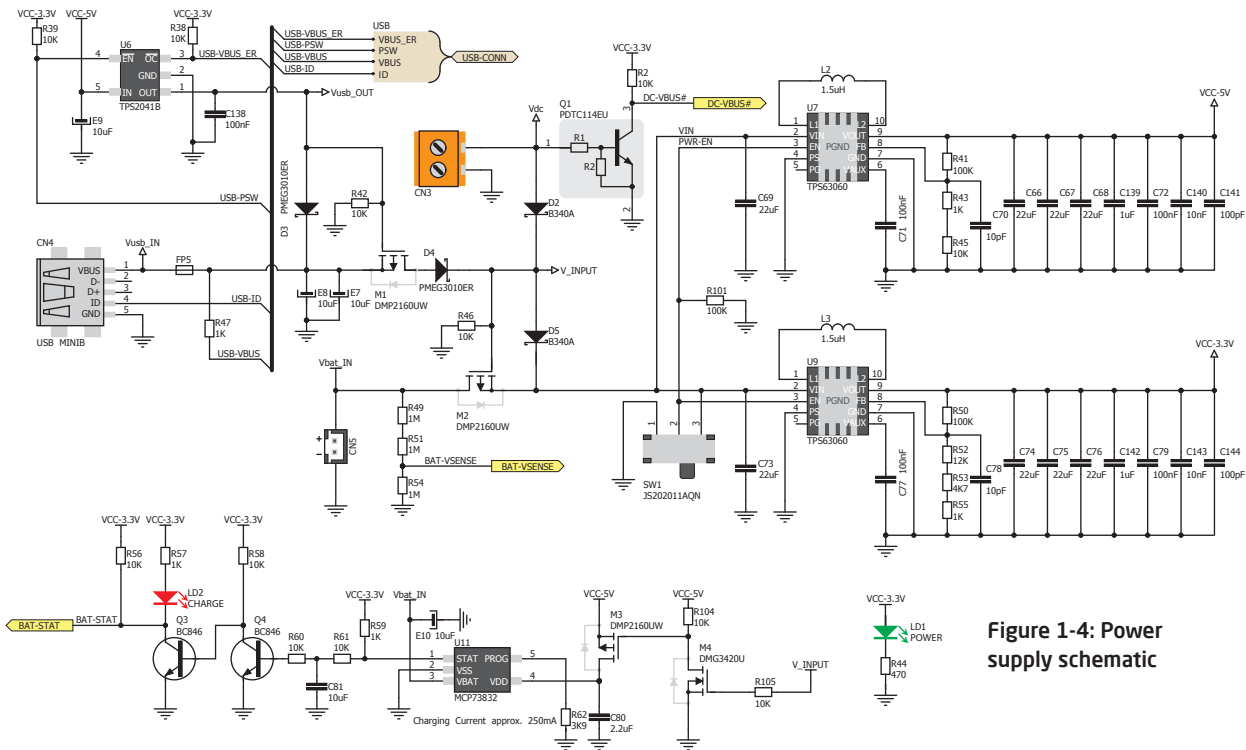

Figure 1-4: Power supply schematic

2. STM32F746ZG microcontroller

The mikromedia+ for STM32F7 ARM® development board comes with the 144-pin **ARM® Cortex™-M7 STM32F746ZG** microcontroller. This high-performance **32-bit** microcontroller with its integrated modules and in combination with other on-board modules is ideal for multimedia applications.

Key microcontroller features

- Up to **462 DMIPS** Operation (216 MHz);
- 1 MB of Flash memory;
- 320 + 64 KB of SRAM memory;
- up to 140 I/O pins;
- 16/32-bit timers
- 16MHz internal oscillator, 32kHz RTCC, PLL;
- 4xUART, 3xSPI, 3xI²C, 2xCAN, 3xADC, 3XADC etc.
- Ethernet, USB etc.

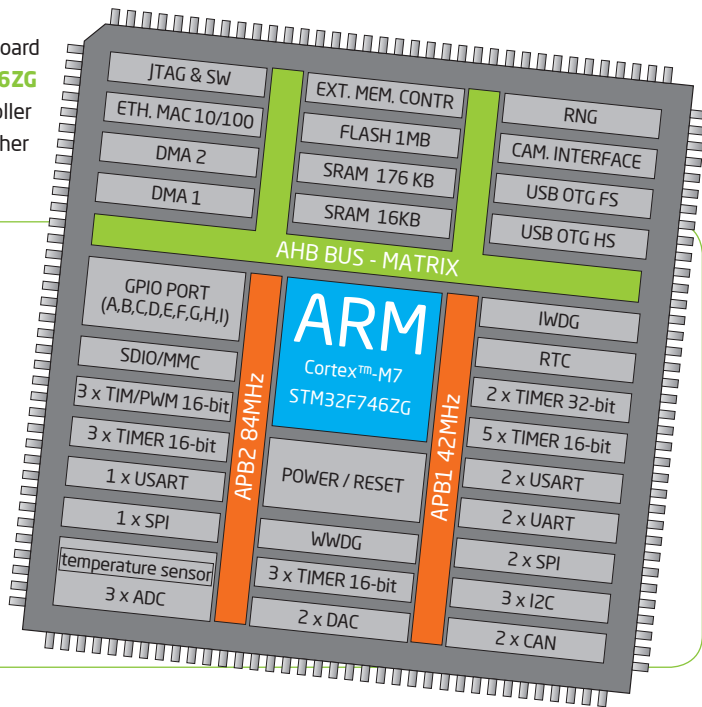

3. Programming the microcontroller

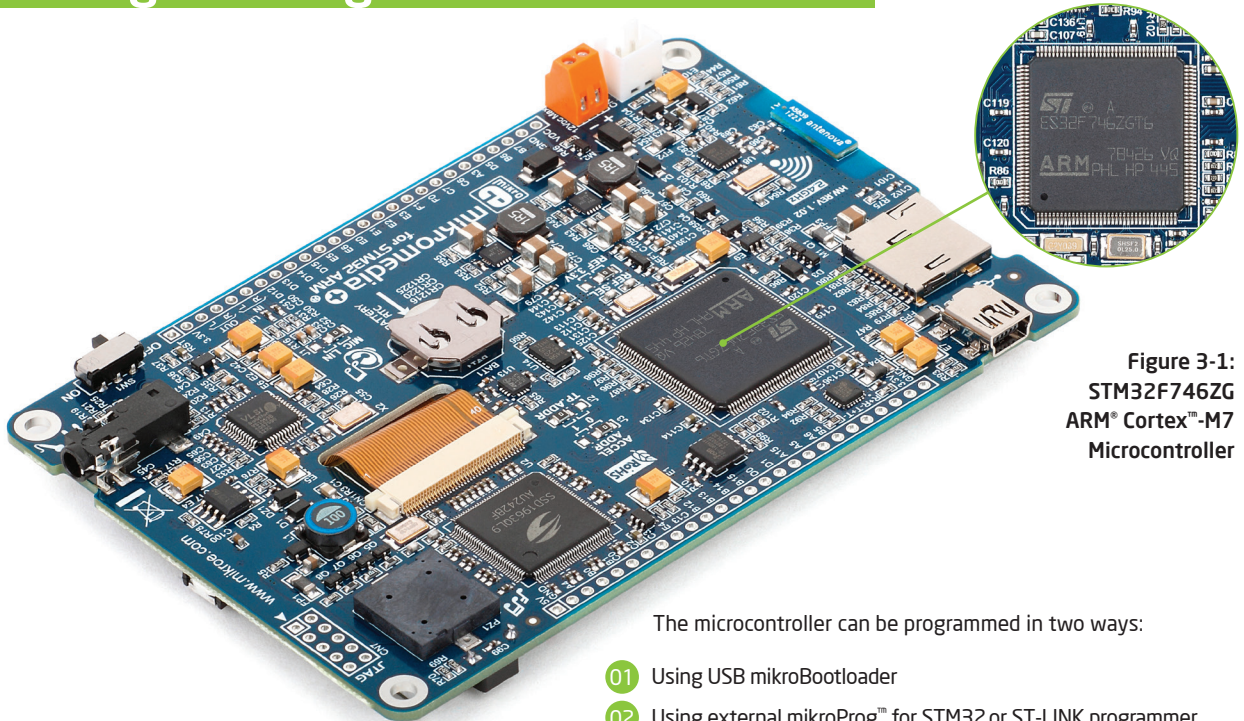

Figure 3-1:
STM32F746ZG
ARM® Cortex™-M7
Microcontroller

The microcontroller can be programmed in two ways:

- 01 Using USB mikroBootloader
- 02 Using external mikroProg™ for STM32 or ST-LINK programmer

Programming with mikroBootloader

You can program the microcontroller with bootloader which is pre programmed into the device by default. To transfer .HEX file from a PC to MCU you need bootloader software (**mikroBootloader USB HID**) which can be downloaded from:



www.mikroe.com/mikromedia/plus/stm32f7

After software is downloaded unzip it to desired location and start mikroBootloader USB HID software.

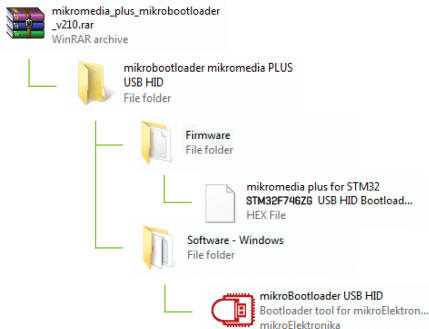

step 1 - Connecting mikromedia



Figure 3-2: USB HID mikroBootloader window

- 01 To start connect the USB cable or (if already connected) press the **Reset** button on your mikromedia+ board. Click the **Connect** button within 5s to enter the bootloader mode, otherwise existing microcontroller program will execute.

step 2 - Browsing for .HEX file



Figure 3-3: Browse for HEX

- 01 Click the **Browse for HEX** button and from a pop-up window (**Figure 3.4**) choose the .HEX file that will be uploaded to MCU memory.

step 3 - Selecting .HEX file

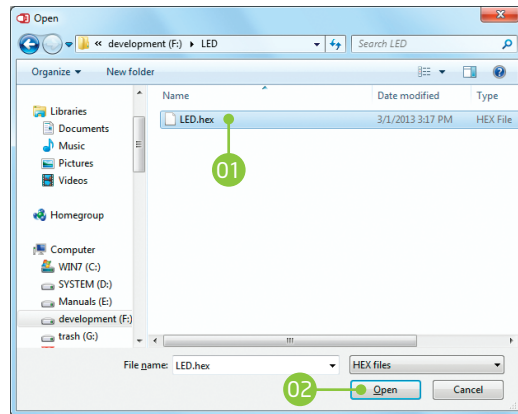

Figure 3-4: Selecting HEX

- 01 Select .HEX file using open dialog window.
- 02 Click the **Open** button.

step 4 - Uploading .HEX file



Figure 3-5: Begin uploading

- 01 To start .HEX file uploading click the **Begin uploading** button.



Figure 3-6: Progress bar

- 01 You can monitor .HEX file uploading via progress bar

step 5 - Finish upload

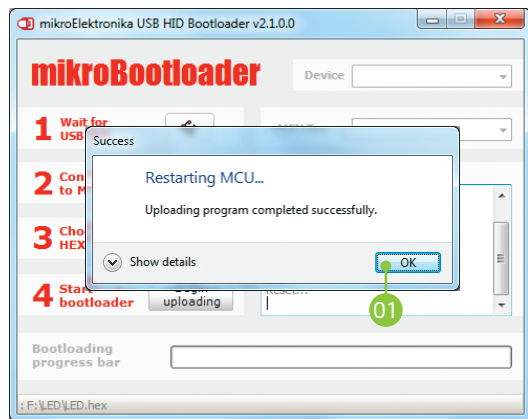

Figure 3-7: Restarting MCU

- 01 Click the **OK** button after uploading is finished. Board will automatically reset and after 5 seconds your new program will execute.



Figure 3-8: mikroBootloader ready for next job

Programming with mikroProg™ programmer

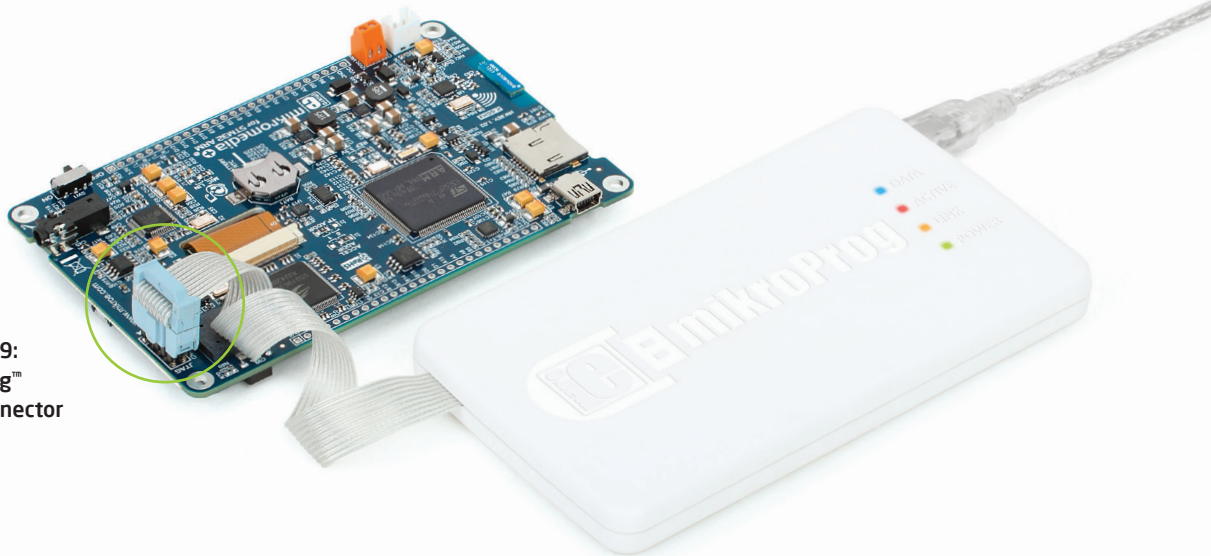

Figure 3-9:
mikroProg™
JTAG connector

The microcontroller can be programmed with external **mikroProg™ for STM32 programmer** and **mikroProg Suite™ for ARM® software**. The external programmer is connected to the development system via JTAG connector, **Figure 3-9. mikroProg™** is a fast USB 2.0 programmer with hardware Debugger support. It supports ARM® Cortex™-M3 and Cortex™-M7 microcontrollers from STM32. Outstanding performance, easy operation and elegant design are its key features.

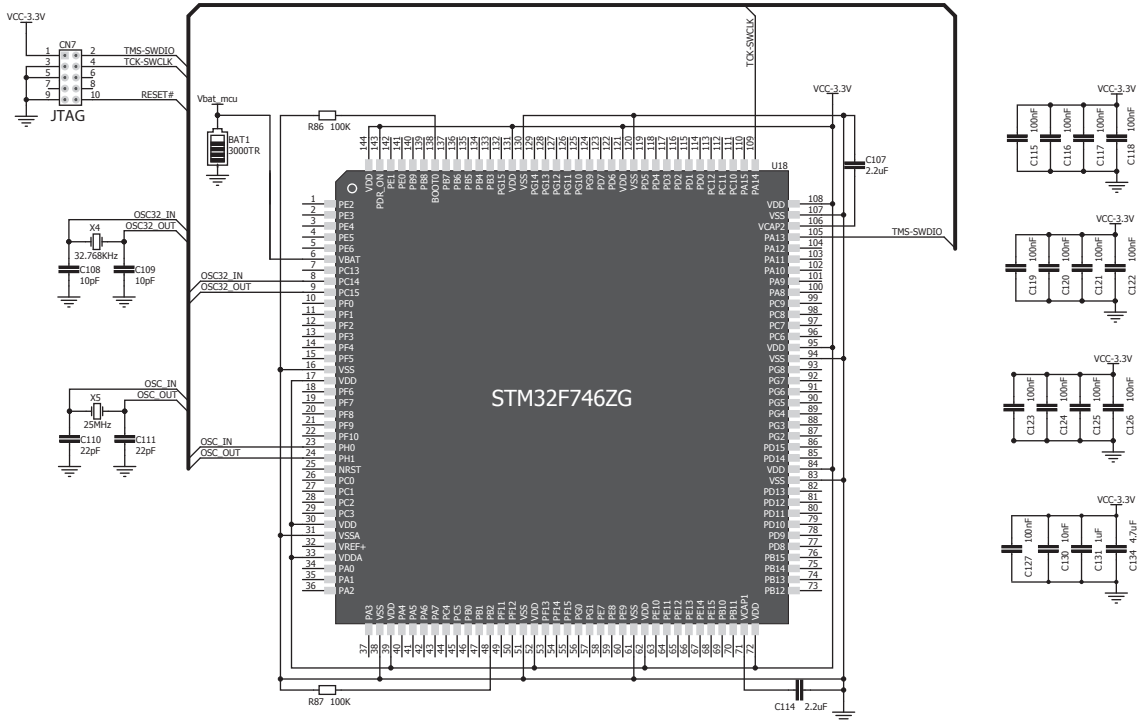
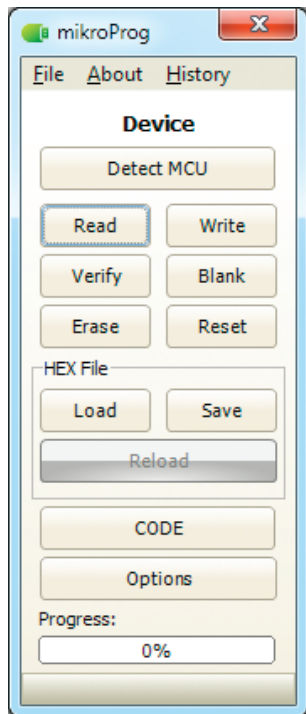

Figure 3-10: mikroProg™ JTAG connector connection schematic

mikroProg Suite™ for ARM® software



mikroProg™ for STM32 programmer requires special programming software called mikroProg Suite™ for ARM®. This software is used for programming ALL of STM32 ARM® Cortex-M3™, Cortex-M4™ and Cortex-M7™ microcontroller families. It features an intuitive interface and SingleClick™ programming technology. Software installation is available on a Product DVD:



http://www.mikroe.com/downloads/get/1809/mikroprog_suite_for_arm.zip

After downloading, extract the package and double click the executable setup file to start installation.

Quick Guide

- 01 Click the **Detect MCU** button in order to recognize the device ID.
- 02 Click the **Read** button to read the entire microcontroller memory. You can click the **Save** button to save it to target HEX file.
- 03 If you want to write the HEX file to the microcontroller, first make sure to load the target HEX file using the **Load** button. Then click the **Write** button to begin programming.
- 04 Click the **Erase** button to wipe out the microcontroller memory.

Software installation wizard

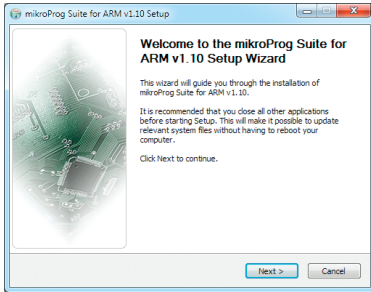

01 Start Installation

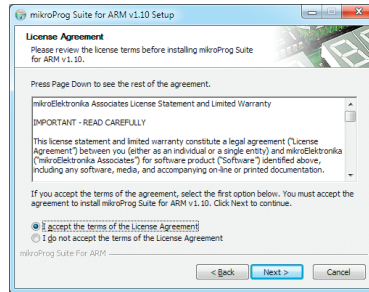

02 Accept EULA and continue

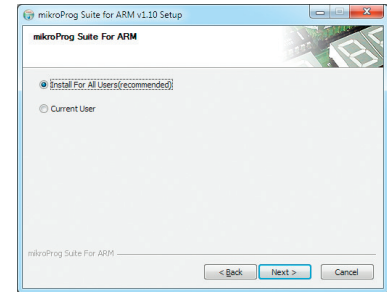

03 Install for all users

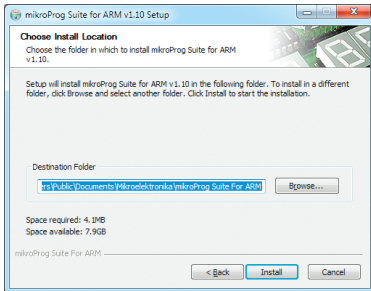

04 Choose destination folder

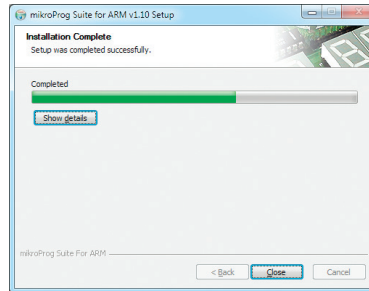

05 Installation in progress

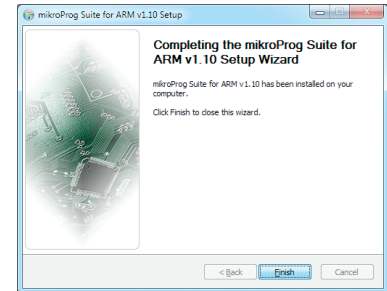

06 Finish installation

4. RTC Battery and Reset Button

Reset Button

The board is equipped with reset button, which is located on the front side of the board. If you want to reset the circuit, press the reset button. It will generate low voltage level on the microcontroller reset pin (input). A reset can also be externally provided through the **pin 27** on the side headers.

RTC Battery

mikromedia+ for STM32F7 ARM® features an RTC battery holder for microcontroller RTC module. Battery is used as alternate source of power, so the RTC module can continue to keep time while the primacy source of power is off or currently unavailable. Three types of coin battery are supported: CR1216, CR1220 and CR1225.

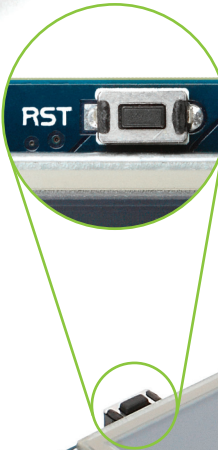
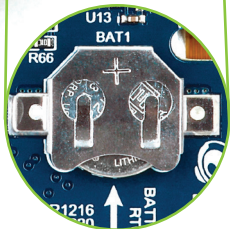

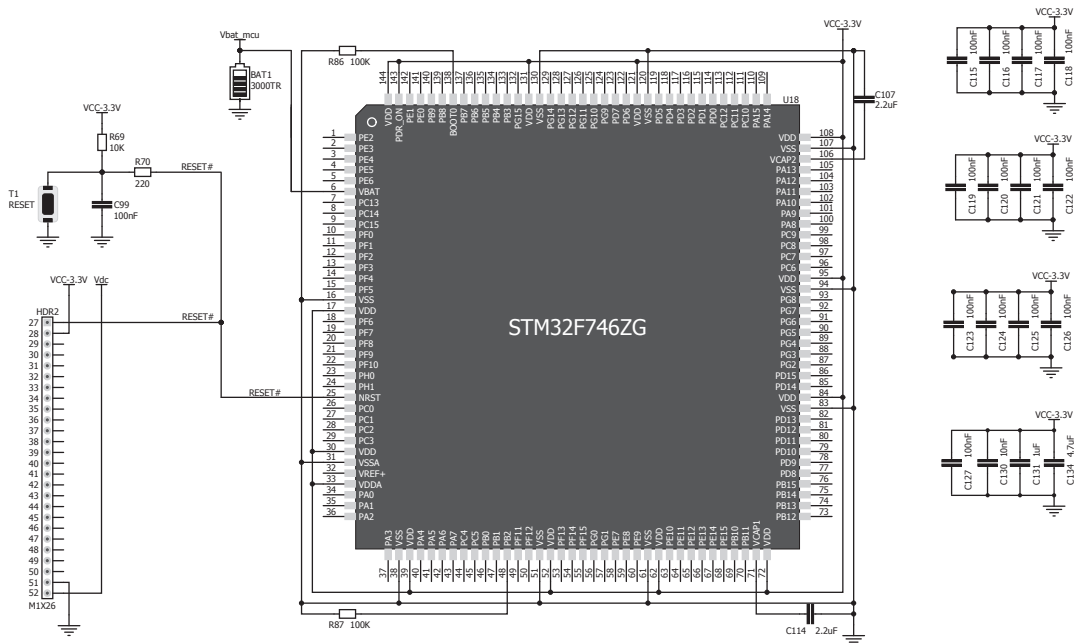

Figure 4-1: Reset circuit and RTC battery schematic

5. Crystal oscillator and 2.048V reference

The board is equipped with **01 25MHz crystal oscillator (X5)** circuit that provides external clock waveform to the microcontroller OSC0 and OSC1 pins. This base frequency is suitable for further clock multipliers and ideal for generation of necessary USB clock, which ensures proper operation of bootloader and your custom USB-based applications. The board also contains **02 32.768 kHz crystal oscillator (X4)** which provides external clock for internal RTCC module. Microcontroller ADC requires an accurate source of reference voltage signal. That is why we provide the external **03 voltage reference** to the microcontroller VREF pin which is **2.048V**.

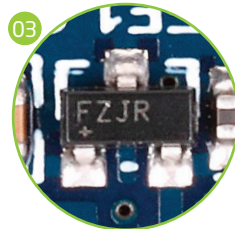
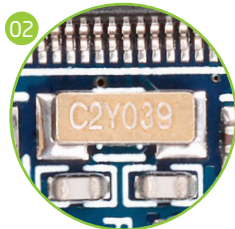
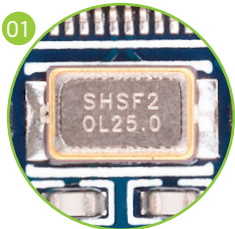
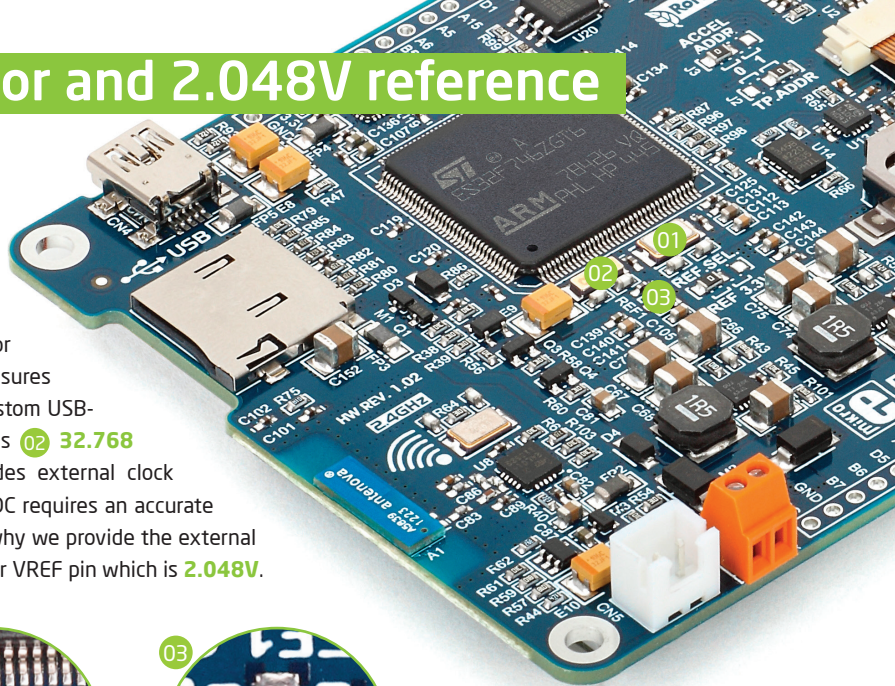

Figure 5-1: Crystal oscillator and 2.048V reference

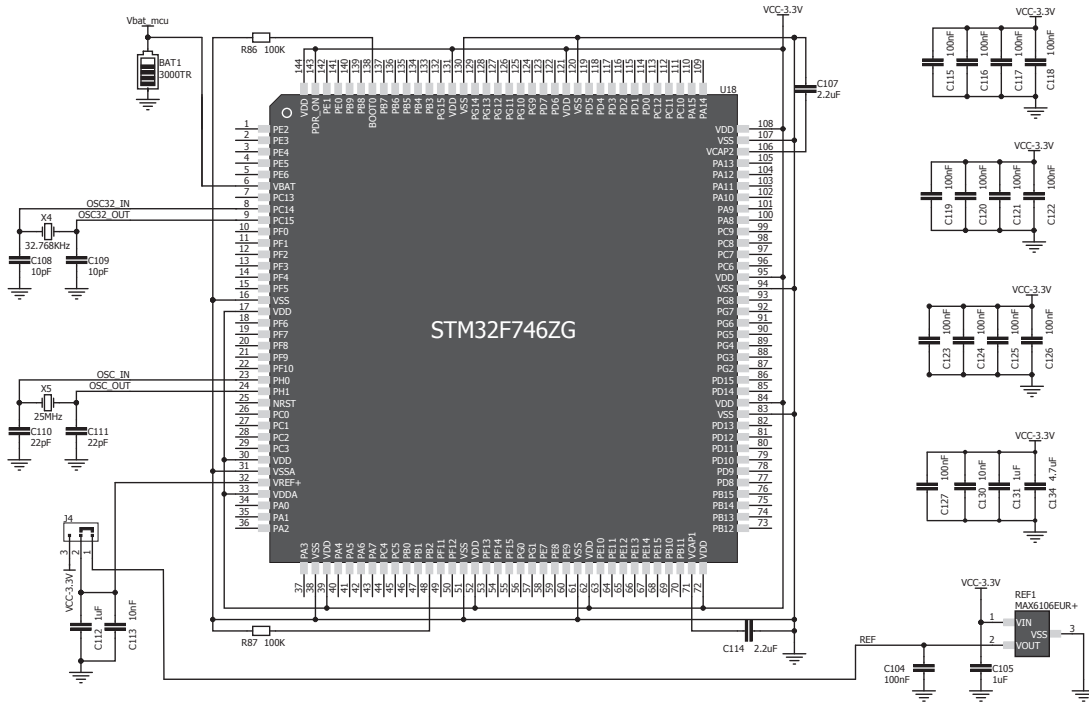
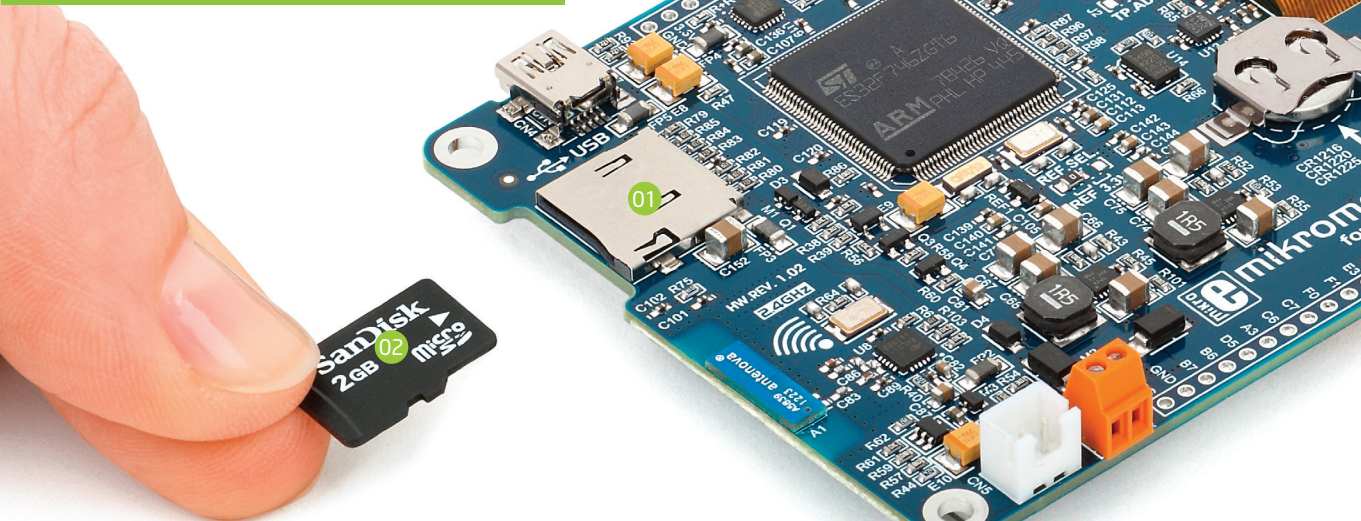

Figure 5-2: Crystal oscillator and voltage reference schematic

6. microSD Card Slot



Board contains **01** **microSD card slot** for using **02** microSD cards in your projects. It enables you to store large amounts of data externally, thus saving microcontroller memory. microSD cards use Serial Peripheral Interface (**SPI**) for communication with the microcontroller. Ferrite and capacitor are provided to compensate the voltage and current glitch that can occur when pushing-in and pushing-out microSD card into the socket. Proper insertion of the microSD card is shown in **Figure 6-1**.

Figure 6-1:
microSD card slot

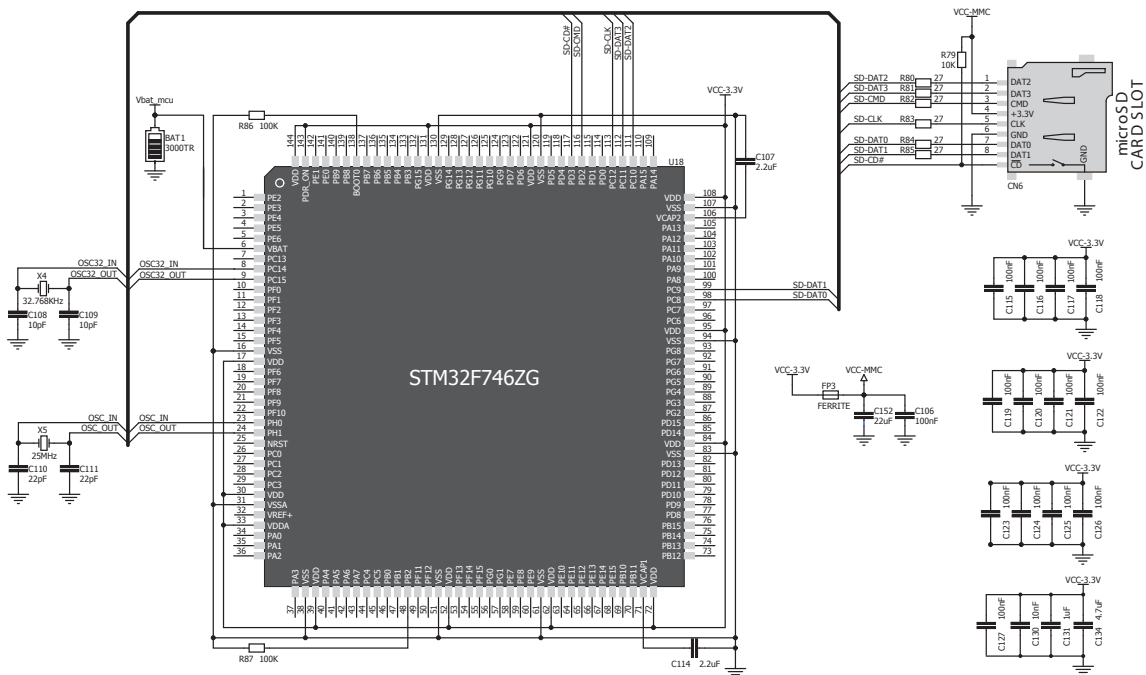

Figure 6-2: microSD Card Slot module connection schematic

7. Touch Screen



The development system features a **4.3" TFT 480x272 display** covered with a **resistive** touch panel. Together they form a functional unit called a **touch screen, Figure 7-1**. It enables data to be entered and displayed at the same time. The TFT display is capable of showing graphics in **256K** different **colors**.

Figure 7-1: Touch Screen

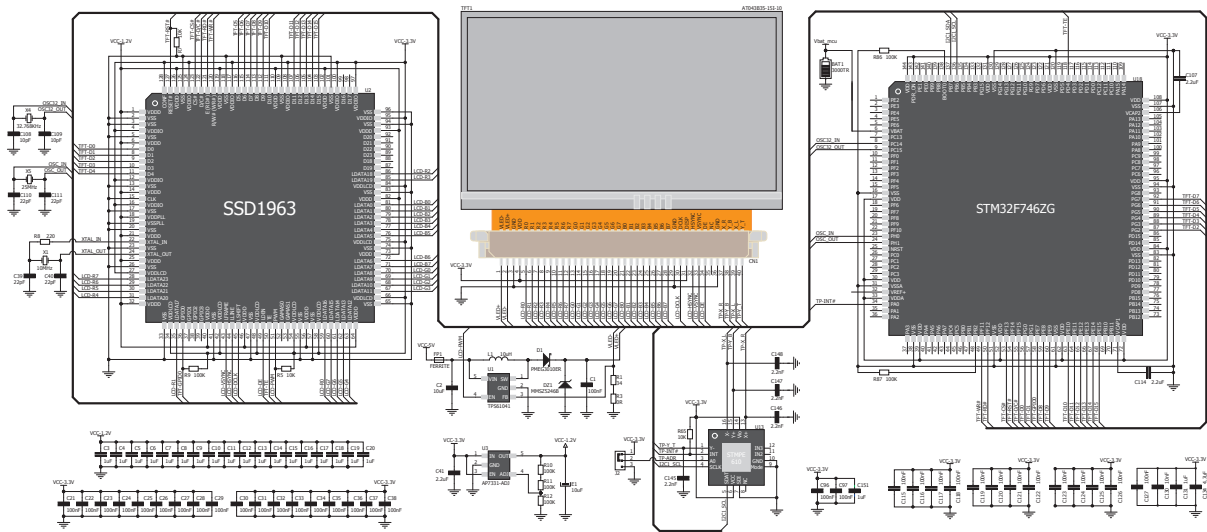
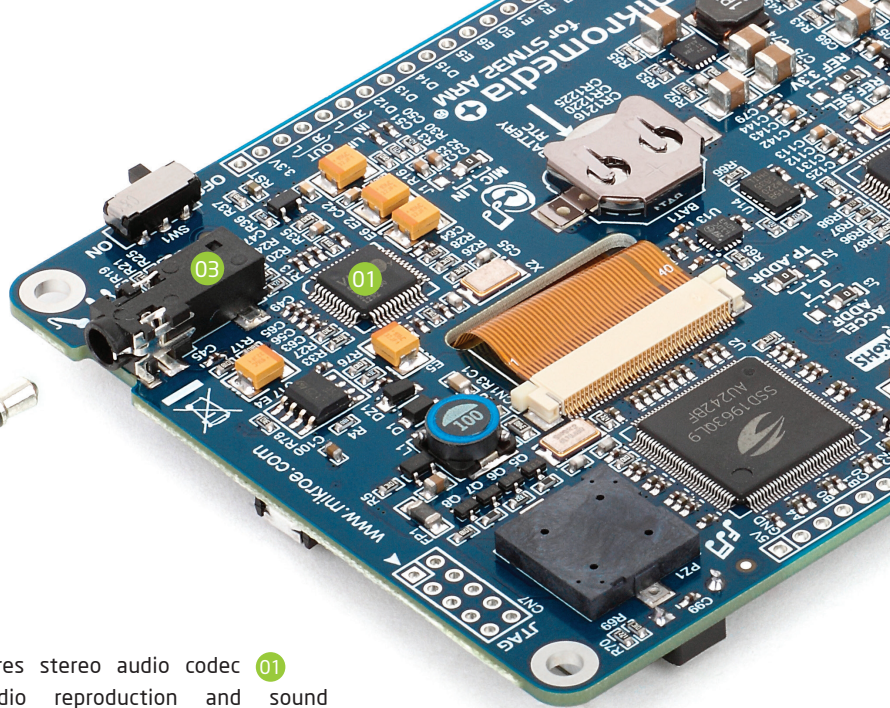

Figure 7-2: Touch Screen connection schematic

8. Audio Module



Figure 8-1:
On-board
VS1053
MP3 codec



mikromedia+ for STM32F7 ARM® features stereo audio codec **01** **VS1053**. This module enables audio reproduction and sound recording by using **02** **stereo headphones with microphone** connected to the system via a **03** **3.5mm** connector CN2. All functions of this module are controlled by the microcontroller over Serial Peripheral Interface (**SPI**). IN and OUT channels are also provided on side headers.

9. USB DEVICE connection

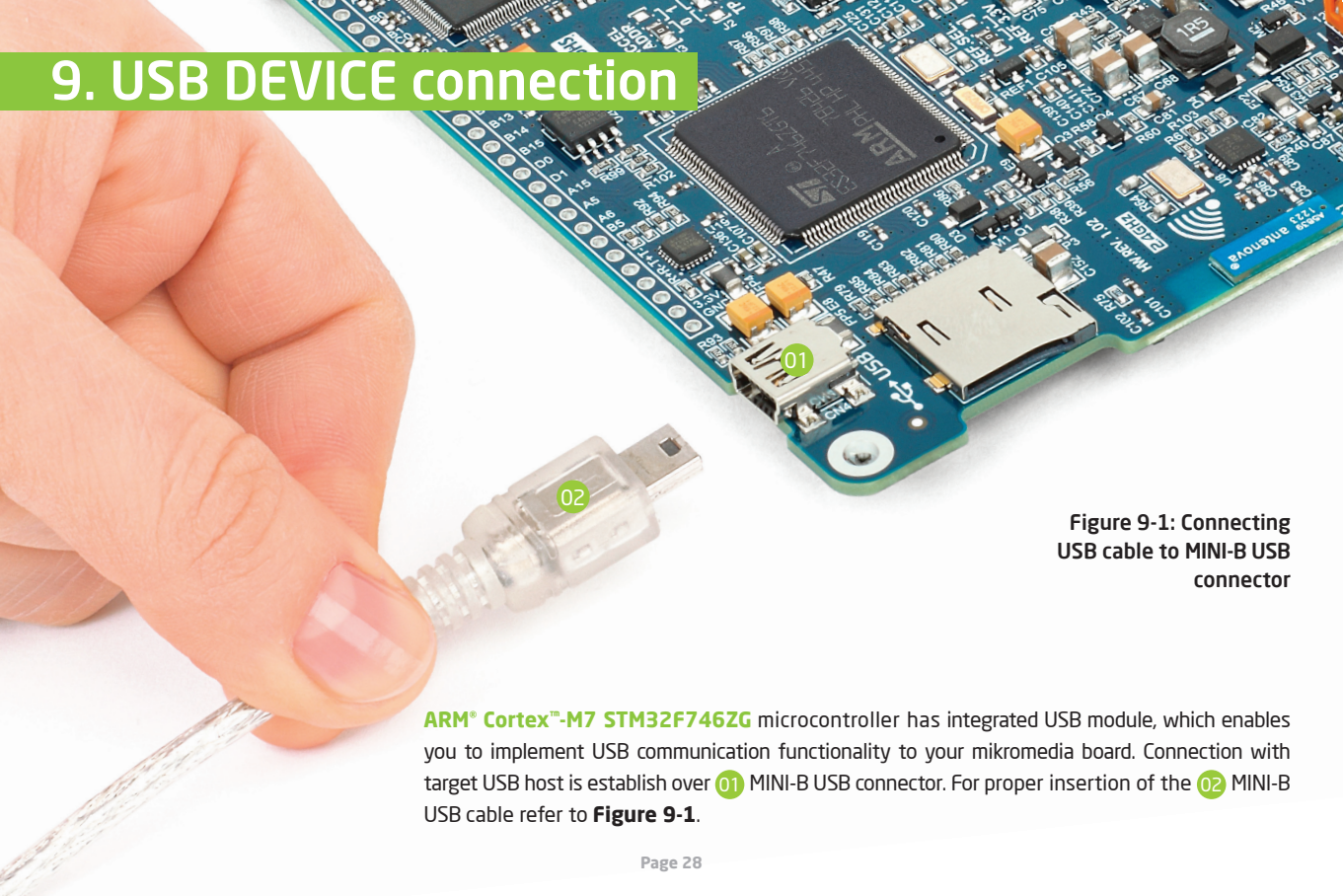

Figure 9-1: Connecting USB cable to MINI-B USB connector

ARM® Cortex™-M7 STM32F746ZG microcontroller has integrated USB module, which enables you to implement USB communication functionality to your mikromedia board. Connection with target USB host is established over **01** MINI-B USB connector. For proper insertion of the **02** MINI-B USB cable refer to **Figure 9-1**.

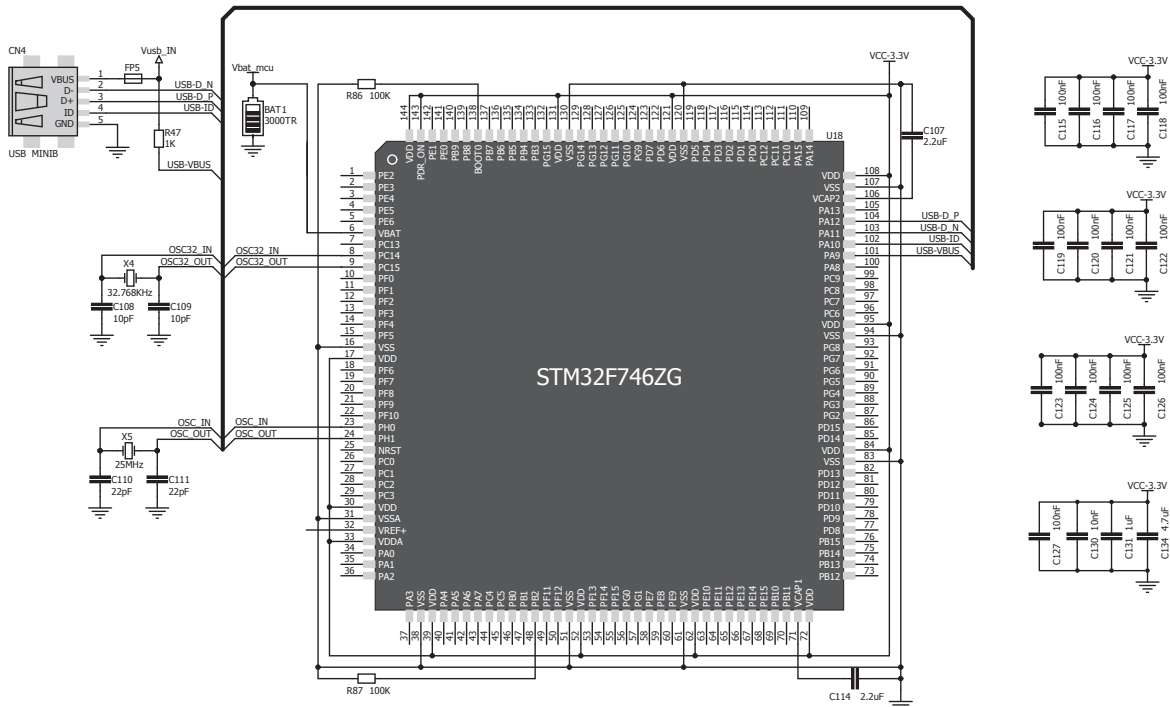

Figure 9-2: USB DEVICE module connection schematic

10. USB HOST connection

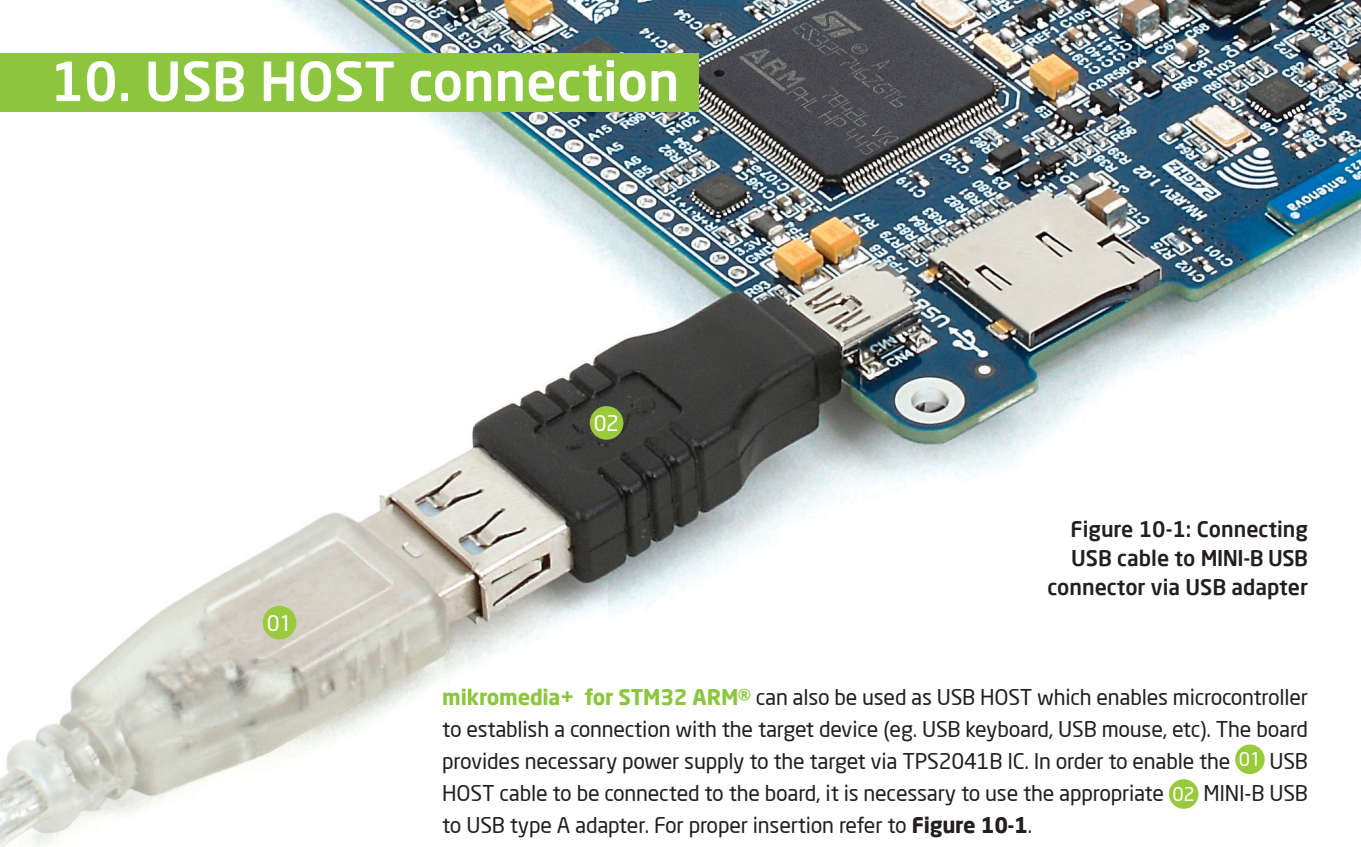

Figure 10-1: Connecting USB cable to MINI-B USB connector via USB adapter

mikromedia+ for STM32 ARM® can also be used as USB HOST which enables microcontroller to establish a connection with the target device (eg. USB keyboard, USB mouse, etc). The board provides necessary power supply to the target via TPS2041B IC. In order to enable the **01** USB HOST cable to be connected to the board, it is necessary to use the appropriate **02** MINI-B USB to USB type A adapter. For proper insertion refer to **Figure 10-1**.

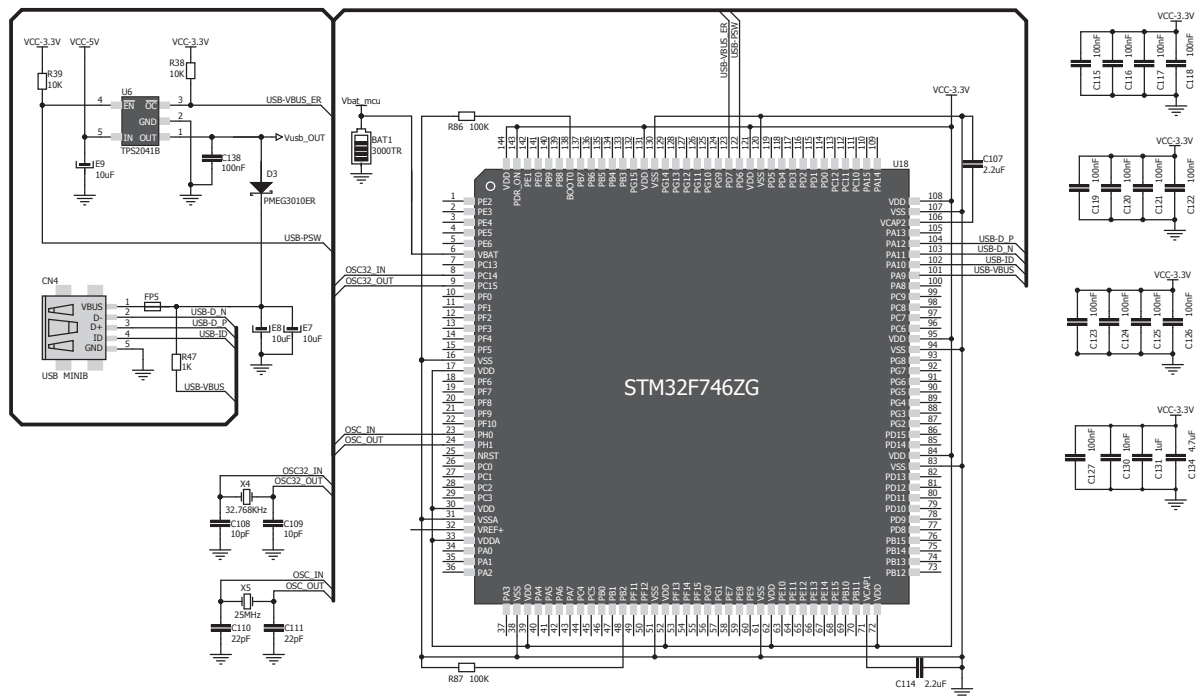

Figure 10-2: USB HOST module connection schematic

11. Accelerometer

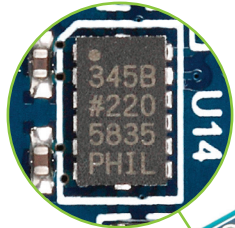
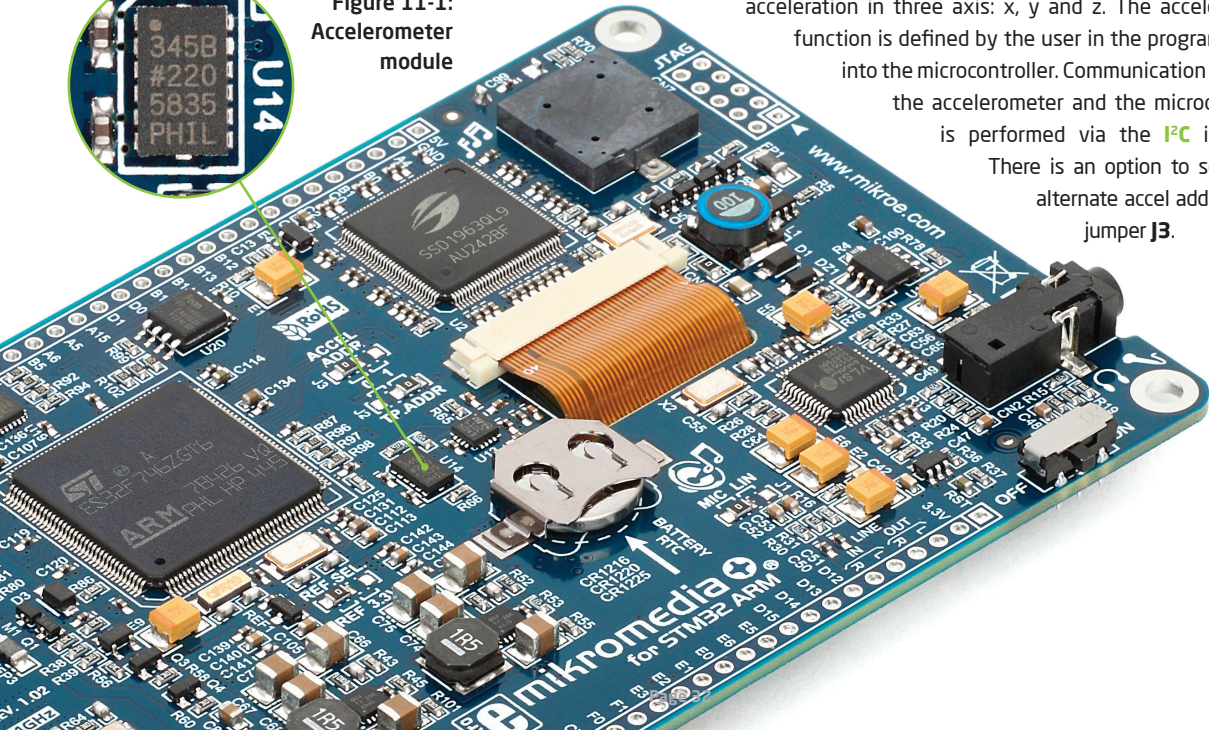

Figure 11-1:
Accelerometer
module

On board **ADXL345** accelerometer is used to measure acceleration in three axis: x, y and z. The accelerometer function is defined by the user in the program loaded into the microcontroller. Communication between the accelerometer and the microcontroller is performed via the **I²C** interface. There is an option to select the alternate accel address with jumper **J3**.



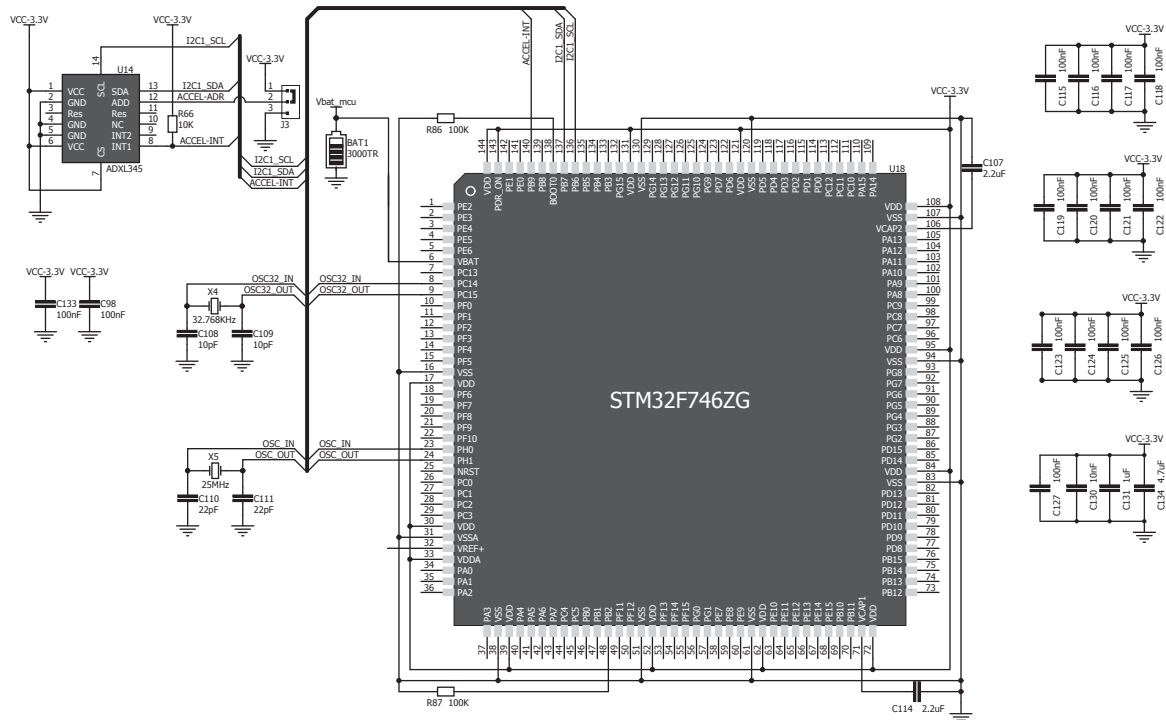

Figure 11-2: Accelerometer connection schematic

12. Flash Memory

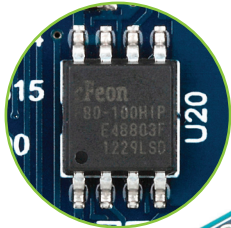
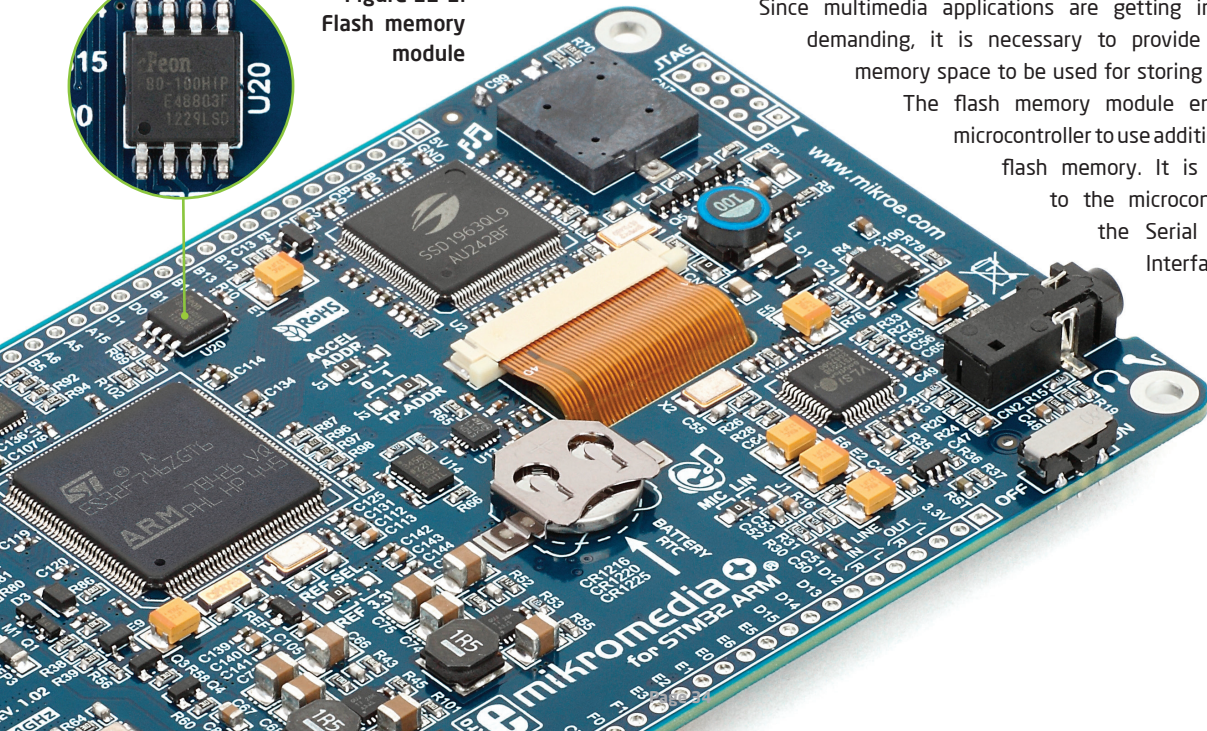

Figure 12-1:
Flash memory
module

Since multimedia applications are getting increasingly demanding, it is necessary to provide additional memory space to be used for storing more data.

The flash memory module enables the microcontroller to use additional **8Mbit** flash memory. It is connected to the microcontroller via the Serial Peripheral Interface (**SPI**).



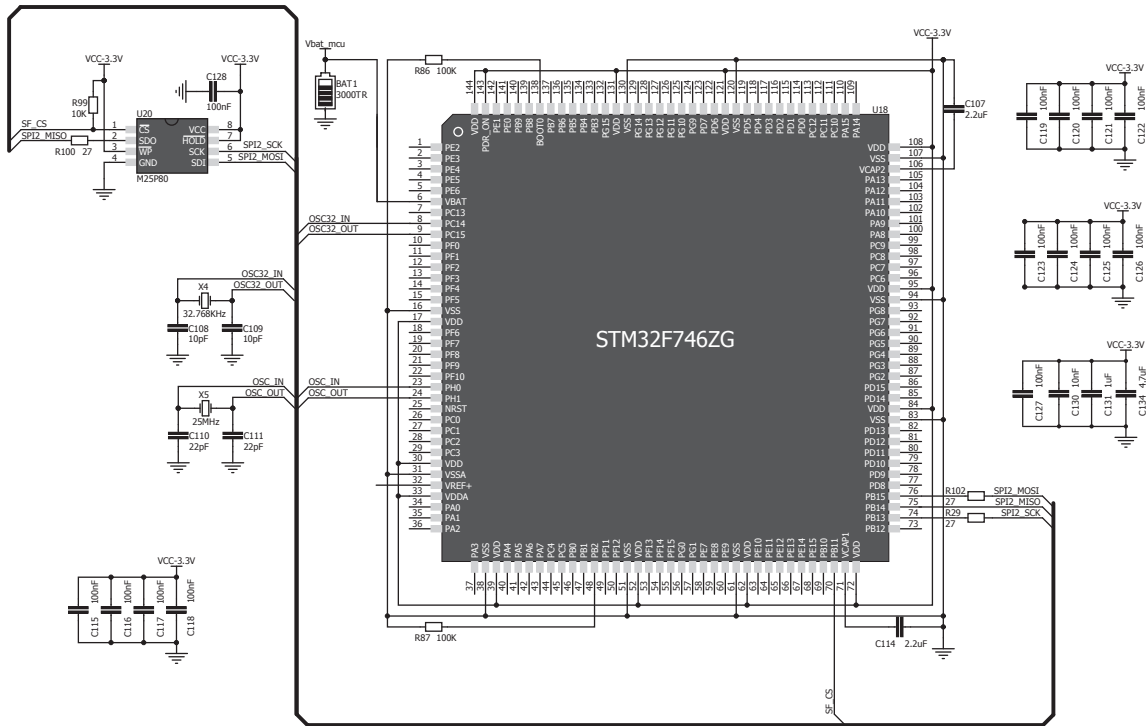

Figure 12-2: Flash memory module connection schematic

13. RF Transceiver

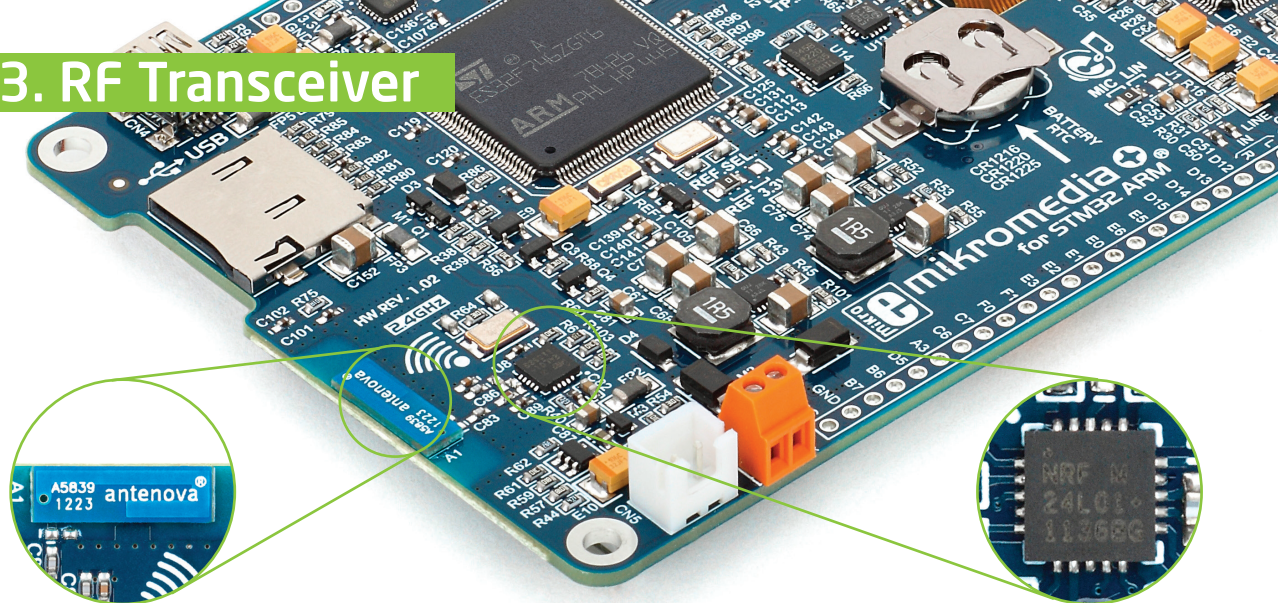

Figure 13-1:
RF transceiver antenna

Figure 13-2:
RF transceiver module

mikromedia+ for STM32F7 ARM® board features **RF transceiver** chip with **2.4GHz chip antenna**. It is suitable for wireless operation in the world wide ISM frequency band at 2.400 - 2.4835 GHz with air data rate up to 2Mbps. RF transceiver module is connected to the microcontroller via the Serial Peripheral Interface (**SPI**). This RF transceiver module is widely used for wireless PC peripherals, remote controllers, VoIP headsets, game controllers, sensors, home and commercial automation, active RFID, toys and many more.

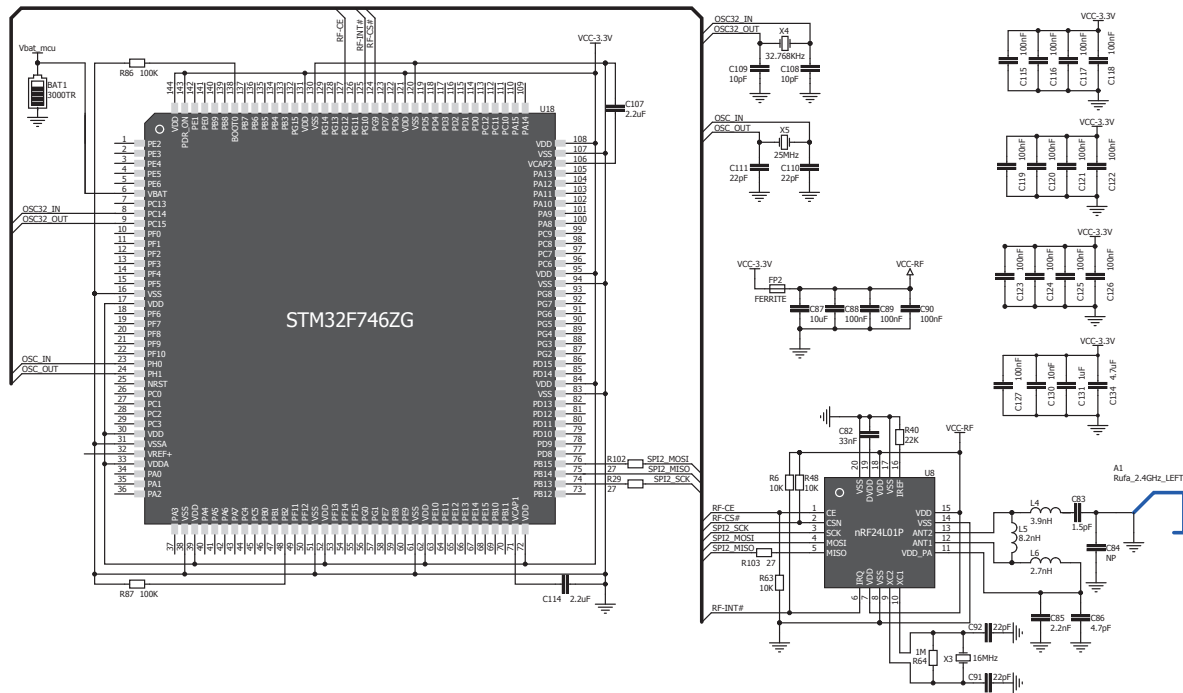

Figure 13-3: RF transceiver module schematic

14. Ethernet transceiver

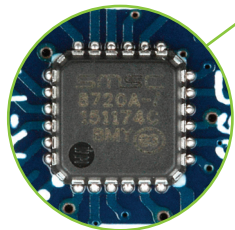
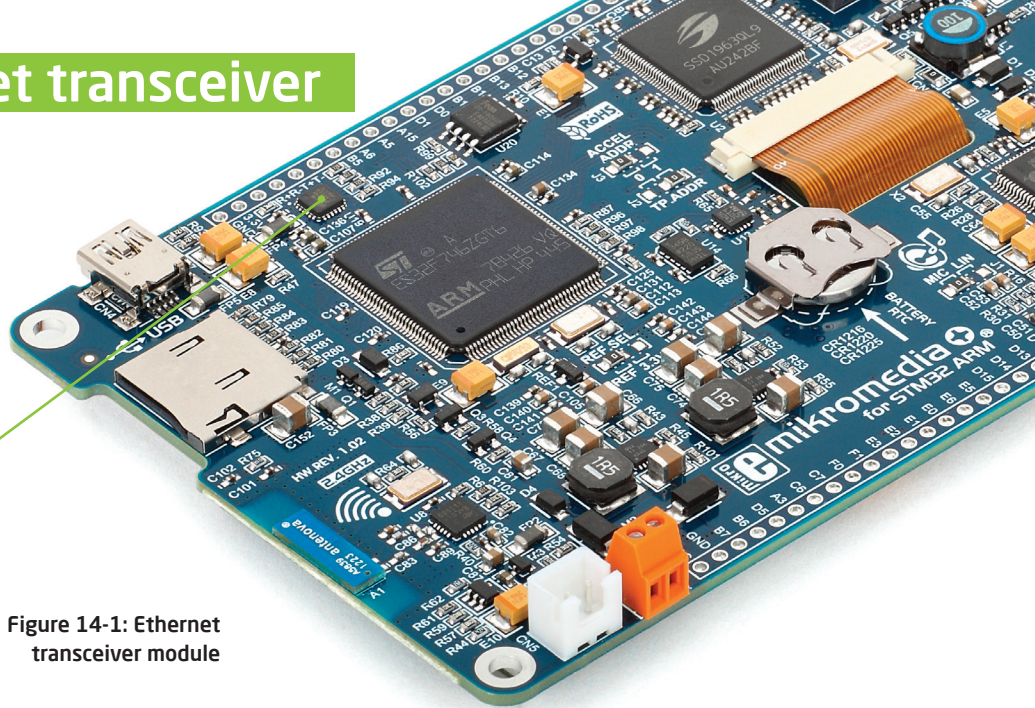

Figure 14-1: Ethernet transceiver module



The development system features a Ethernet transceiver module ideal for local area networking (LAN). Communication over Ethernet is based on data packets called frames. Each frame contains source and destination addresses and error-checking data so that damaged data can be detected and re-transmitted. If you want to establish a connection with computer, router or other devices you need to use standard RJ-45 connector which is provided on **mikromedia+ SHIELD for STM32 ARM®**. Communication lines are also provided over side headers.

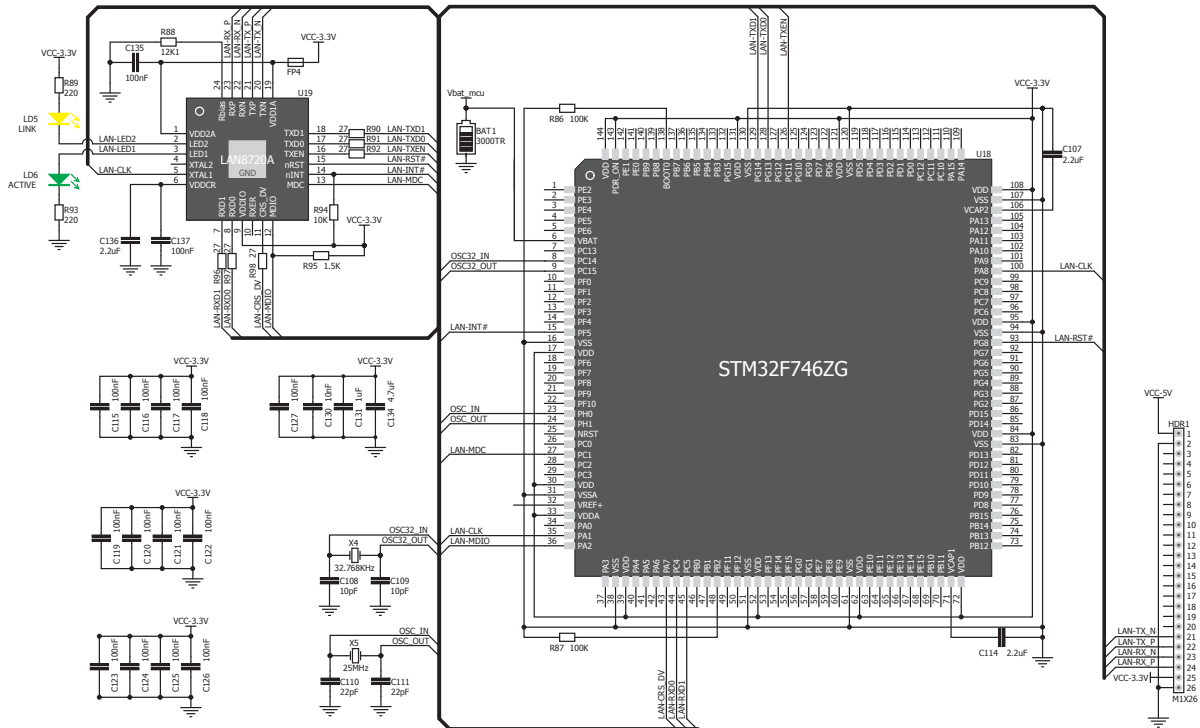

Figure 14-2: Ethernet transceiver module schematic

15. Buzzer

The board is also equipped with piezo buzzer. It is an electric component which can be used to create sound waves when provided with electrical signal. Microcontroller can create sound by generating a PWM signal. Frequency of the signal determines the pitch of the sound and duty cycle of the signal can be used to increase or decrease the volume.

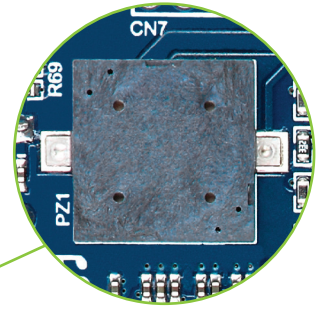
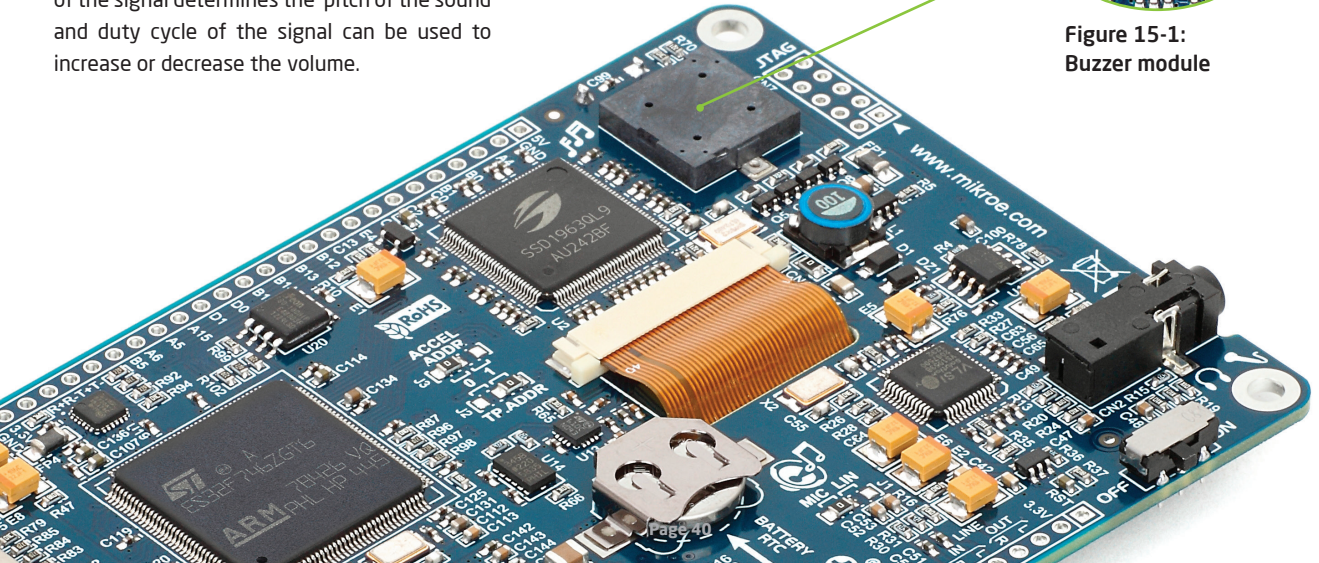

Figure 15-1:
Buzzer module



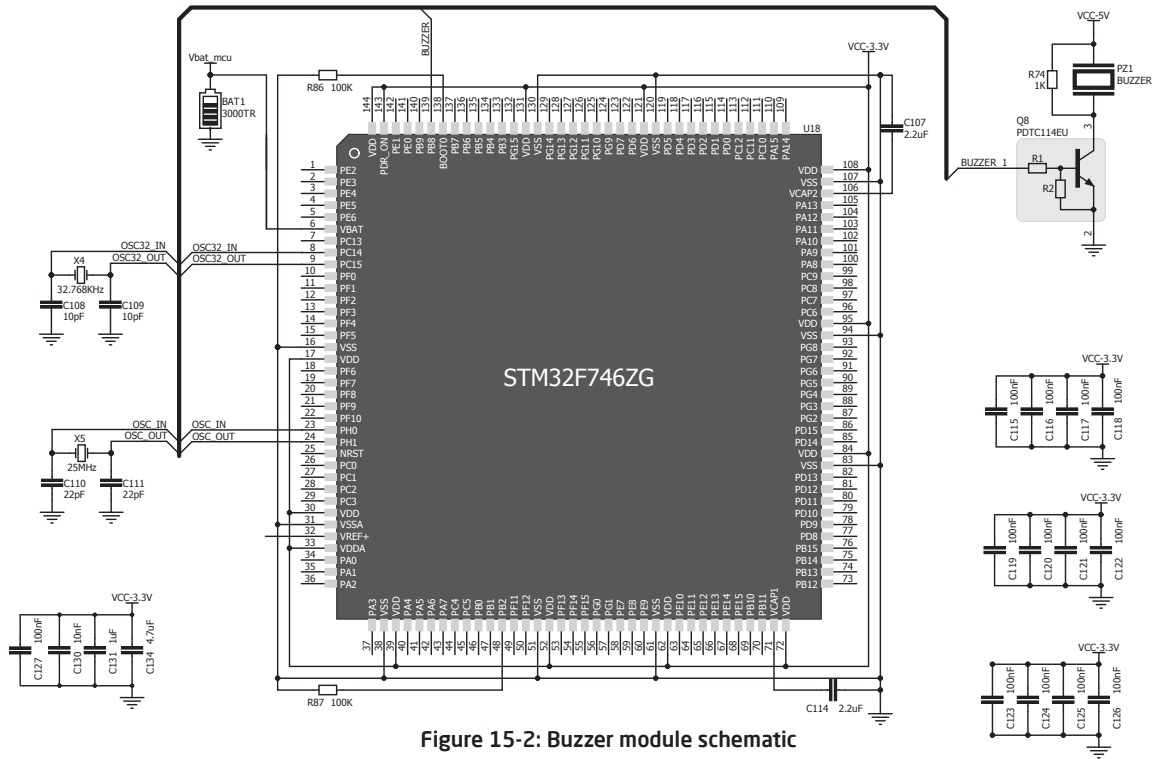
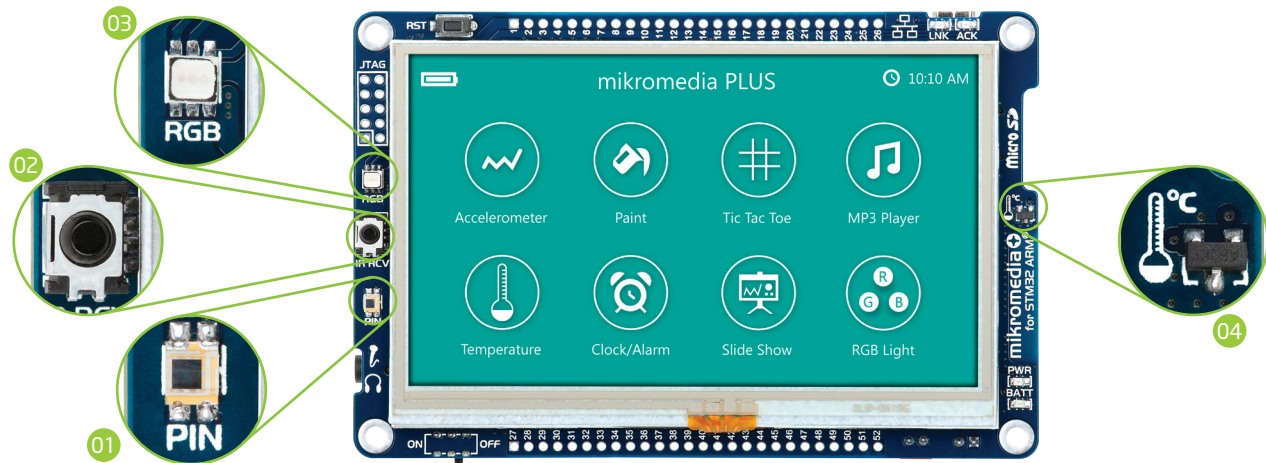

Figure 15-2: Buzzer module schematic

16. Other modules



The board also contains additional peripherals that can be very useful, such as **01** PIN photodiode, **02** IR receiver, **03** RGB led diode and **04** analog temperature sensor. **PIN photodiode** is a type of photo detector capable of converting light into the voltage with high sensitivity and speed of response. It is connected to the microcontroller analog pin. **IR receiver** is used for infrared remote control systems. The demodulated output signal obtained from IR module can be directly decoded by a microcontroller. Many of existing standard data formats are supported. **RGB (Red, Green, Blue) diode** is suitable for light indication in your design. Each of colour is driven separately by transistor. The **analog temperature sensor** converts temperature to analog voltage and it is directly connected to the microcontroller analog pin. Temperature measurement range of mikromedia+ for STM32F7 ARM® board is from -20°C to 70°C.

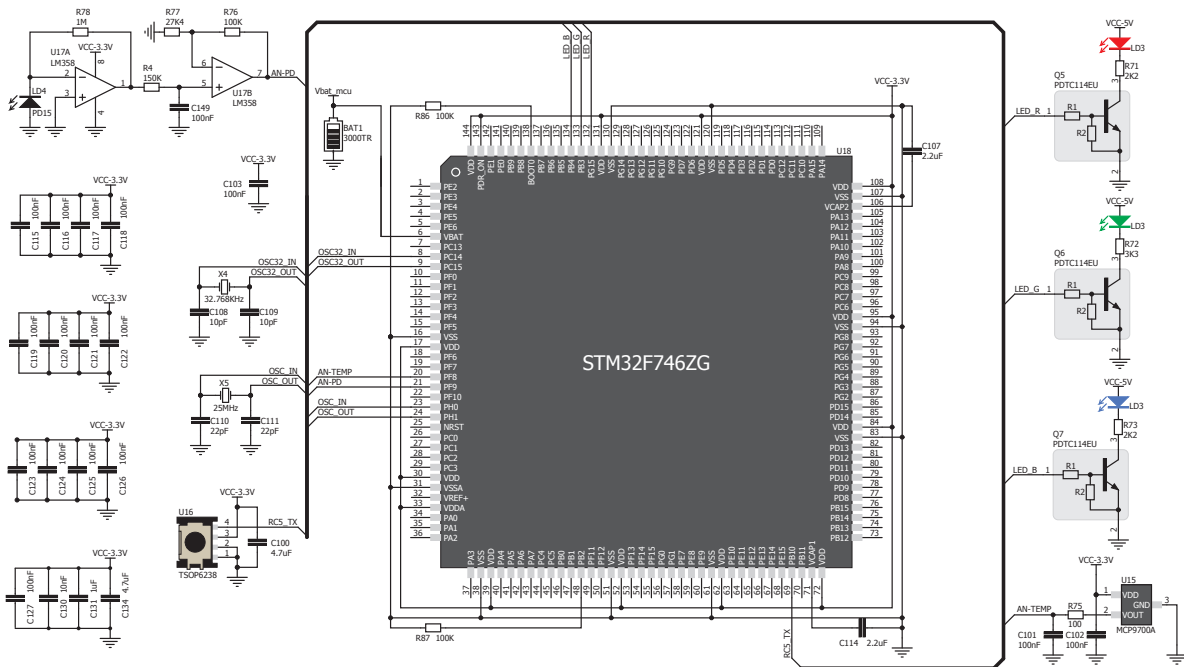
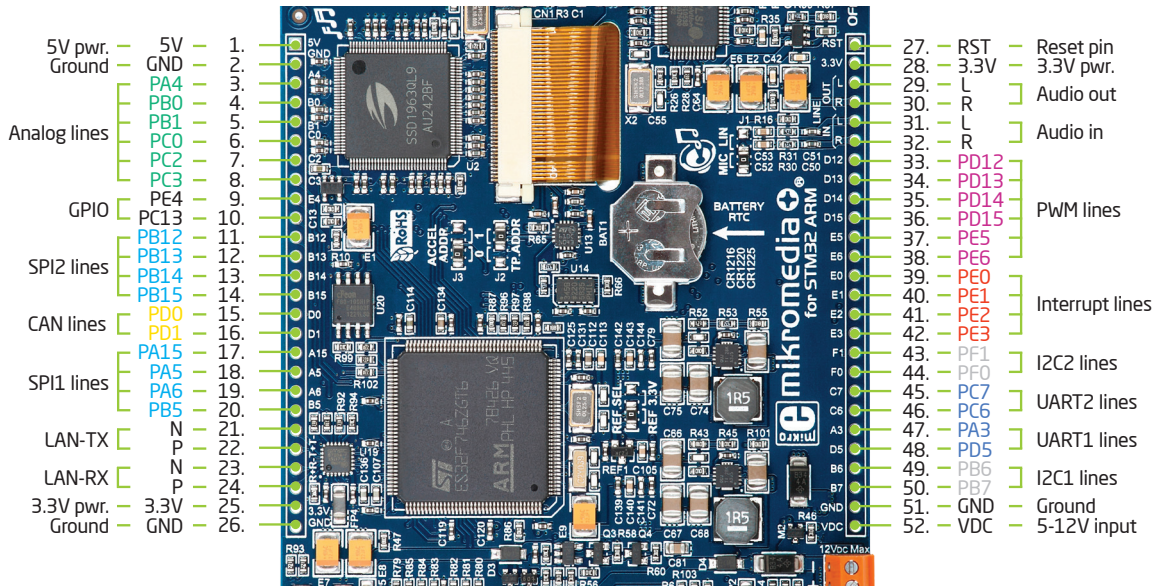

Figure 16-1: Other modules schematic

17. Pads

■ PWM
 ■ Interrupt
 ■ I2C
 ■ UART
 ■ Analog lines
 ■ SPI
 ■ CAN



Many microcontroller pins are available for further connectivity via two 1x26 rows of connection pads on both sides of the board. They are designed to match with mikromedia+ SHIELD for STM32 ARM®.

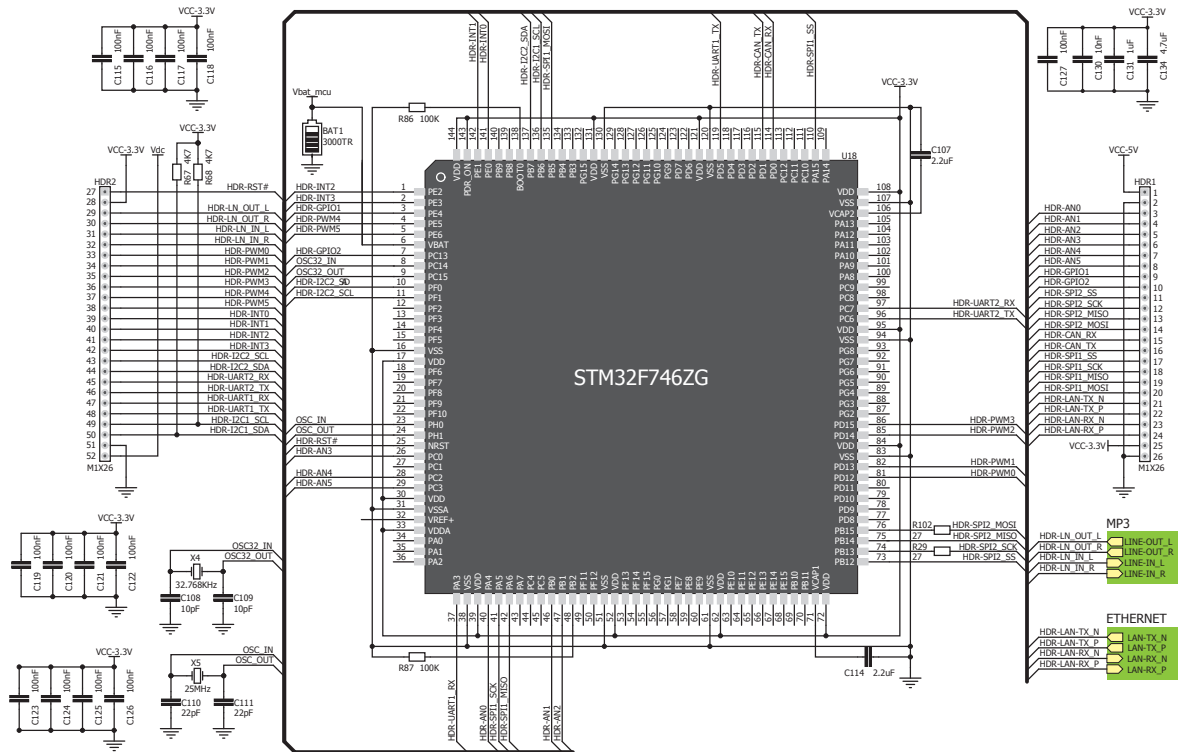

Figure 17-1: Connecting pads schematic

mikromedia+ for STM32F7 shield

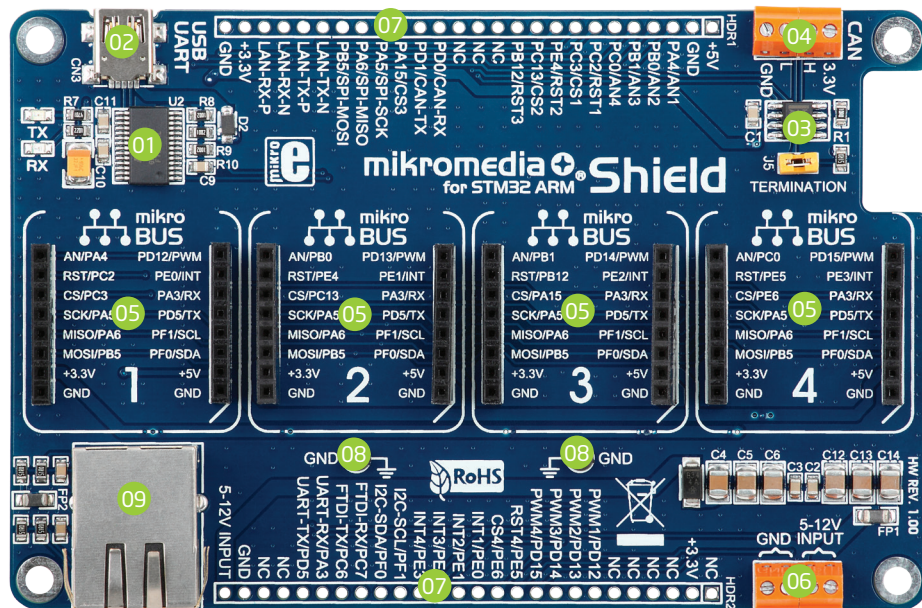

Figure 18-1: mikromedia+ shield

We have prepared an extension board pin-compatible with your mikromedia+ board, which enables you to easily expand your basic board functionality. It is called **mikromedia+ SHIELD for STM32 ARM®**. The shield contains 01 FTDI USB-UART chip with 02 USB MINI-B connector, 03 CAN transceiver with 04 CAN screw terminals, four 05 mikroBUS sockets, 06 screw terminals for external power supply, 07 side connection pads, additional 08 GNDs and 09 Ethernet connector. **mikromedia+ SHIELD for STM32 ARM®** is additional board and it is not provided in the package.

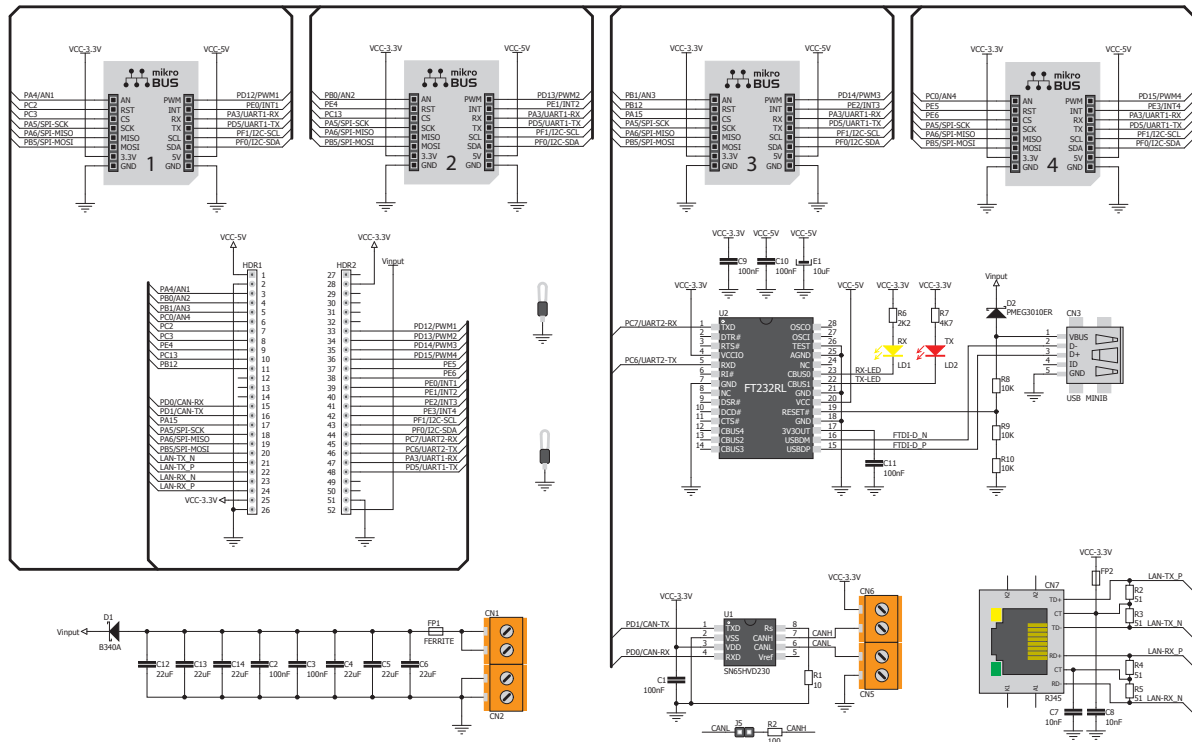

Figure 18-2: mikromedia+ shield schematic

What's next?

You have now completed the journey through each and every feature of mikromedia+ for STM32F7 ARM® board. You got to know it's modules and organization. Now you are ready to start using your new board. We are suggesting several steps which are probably the best way to begin. We invite you to join the users of mikromedia™ brand. You will find very useful projects and tutorials and can get help from a large ecosystem of users. Welcome!

Compiler

You still don't have an appropriate compiler? Locate ARM® compiler that suits you best on our website:

<http://www.mikroe.com/compilers/arm/>

Choose between mikroC™, mikroBasic™ and mikroPascal™ and download fully functional demo version, so you can start building your first applications.



Projects

Once you have chosen your compiler, and since you already got the board, you are ready to start writing your first projects. **Visual TFT software** for rapid development of graphical user interfaces enables you to quickly create your GUI. It will automatically create necessary code which is compatible with MikroElektronika compilers. Visual TFT is rich with examples, which are an excellent starting point for your future projects. Just load the example, read well commented code, and see how it works on hardware. Visual TFT is also available on the link below:

<http://www.mikroe.com/visualtft/>

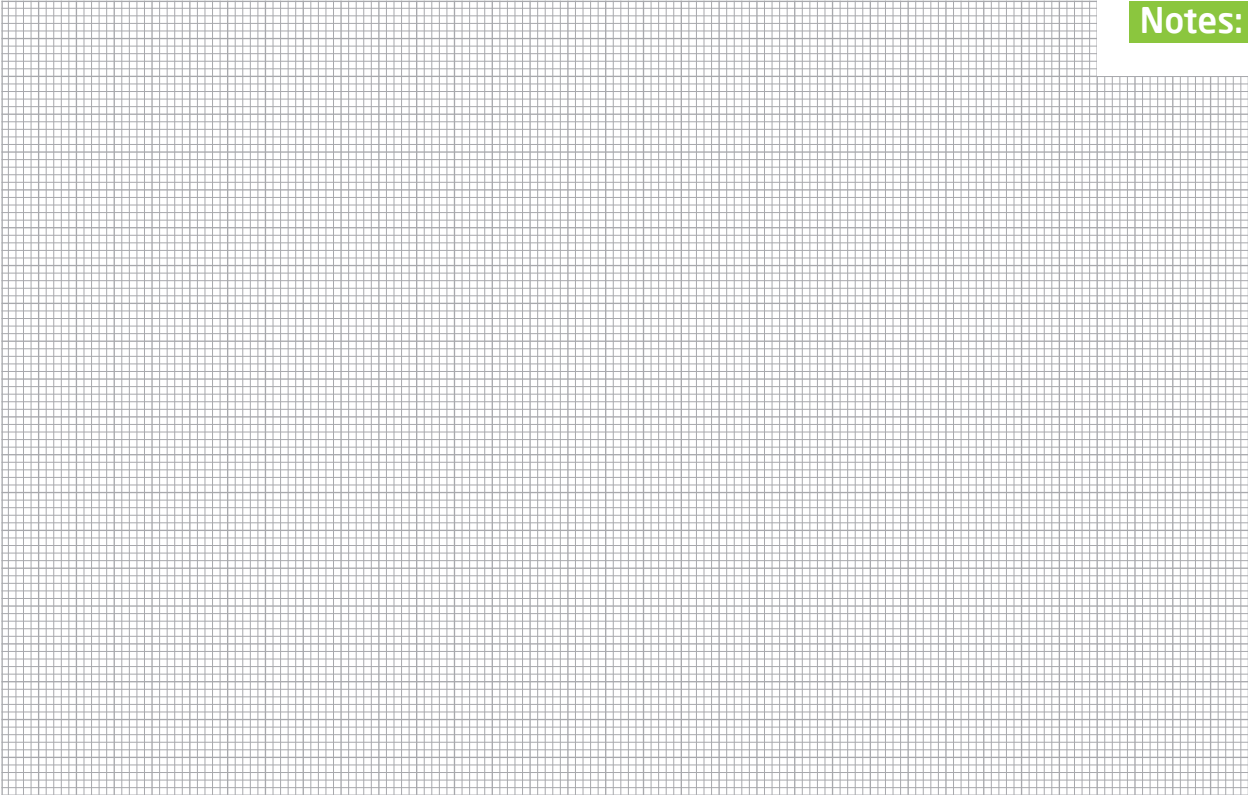

Notes:

DISCLAIMER

All the products owned by MikroElektronika are protected by copyright law and international copyright treaty. Therefore, this manual is to be treated as any other copyright material. No part of this manual, including product and software described herein, may be reproduced, stored in a retrieval system, translated or transmitted in any form or by any means, without the prior written permission of MikroElektronika. The manual PDF edition can be printed for private or local use, but not for distribution. Any modification of this manual is prohibited.

MikroElektronika provides this manual 'as is' without warranty of any kind, either expressed or implied, including, but not limited to, the implied warranties or conditions of merchantability or fitness for a particular purpose.

MikroElektronika shall assume no responsibility or liability for any errors, omissions and inaccuracies that may appear in this manual. In no event shall MikroElektronika, its directors, officers, employees or distributors be liable for any indirect, specific, incidental or consequential damages (including damages for loss of business profits and business information, business interruption or any other pecuniary loss) arising out of the use of this manual or product, even if MikroElektronika has been advised of the possibility of such damages. MikroElektronika reserves the right to change information contained in this manual at any time without prior notice, if necessary.

HIGH RISK ACTIVITIES

The products of MikroElektronika are not fault - tolerant nor designed, manufactured or intended for use or resale as on - line control equipment in hazardous environments requiring fail - safe performance, such as in the operation of nuclear facilities, aircraft navigation or communication systems, air traffic control, direct life support machines or weapons systems in which the failure of Software could lead directly to death, personal injury or severe physical or environmental damage ('High Risk Activities'). MikroElektronika and its suppliers specifically disclaim any expressed or implied warranty of fitness for High Risk Activities.

TRADEMARKS

The MikroElektronika name and logo, the MikroElektronika logo, mikroC™, mikroBasic™, mikroPascal™, mikroProg™, mikroBUS™, Click Boards™, EasyMx PRO™ and mikromedia™ are trademarks of MikroElektronika. All other trademarks mentioned herein are property of their respective companies.

All other product and corporate names appearing in this manual may or may not be registered trademarks or copyrights of their respective companies, and are only used for identification or explanation and to the owners' benefit, with no intent to infringe.



If you want to learn more about our products, please visit our website at www.mikroe.com

If you are experiencing some problems with any of our products or just need additional information, please place your ticket at www.mikroe.com/support/

If you have any questions, comments or business proposals,
do not hesitate to contact us at office@mikroe.com

mikromedia Plus for STM32F7
Manual v1.00

