



## 14 Gbps, FAST RISE TIME XOR / XNOR GATE

### Typical Applications

The HMC725LC3C is ideal for:

- 16 G Fiber Channel
- RF ATE Applications
- Broadband Test & Measurement
- Serial Data Transmission up to 14 Gbps
- Digital Logic Systems up to 14 GHz

### Features

- Inputs Terminated Internally to 50 Ohms
- Differential or Single-Ended Operation
- Fast Rise and Fall Times: 19 / 18 ps
- Low Power Consumption: 230 mW typ.
- Propagation Delay: 105 ps
- Single Supply: -3.3 V
- 16 Lead Ceramic 3x3 mm SMT Package: 9 mm<sup>2</sup>

### Functional Diagram

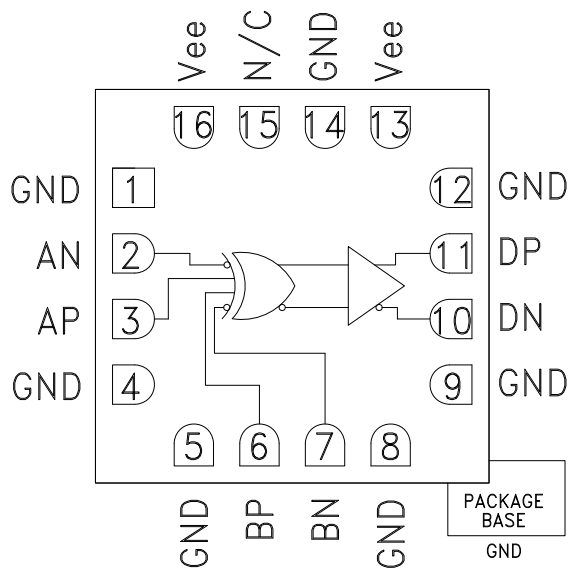

### General Description

The HMC725LC3C is a XOR/XNOR gate function designed to support data transmission rates of up to 14 Gbps, and clock frequencies as high as 14 GHz.

All differential inputs to the HMC725LC3C are CML and terminated on-chip with 50 Ohms to the positive supply, GND, and may be DC or AC coupled. The differential CML outputs are source terminated to 50 Ohms and may also be AC or DC coupled. Outputs can be connected directly to a 50 Ohm ground-terminated system or drive devices with CML logic input. The HMC725LC3C operates from a single -3.3 V supply and is available in ROHS-compliant 3x3 mm SMT package.

### Electrical Specifications, $T_A = +25\text{ }^\circ\text{C}$ , $V_{ee} = -3.3\text{ V}$

Parameter	Conditions	Min.	Typ.	Max	Units
Power Supply Voltage		-3.6	-3.3	-3.0	V
Power Supply Current			70		mA
Maximum Data Rate			14		Gbps
Maximum Clock Rate			14		GHz
Input Voltage Range		-1.5		0.5	V
Input Differential Range		0.1		2.0	Vp-p
Input Return Loss	Frequency <14 GHz		10		dB
Output Amplitude	Single-Ended, peak-to-peak		550		mVp-p
	Differential, peak-to-peak		1100		mVp-p
Output High Voltage			-10		mV
Output Low Voltage			-560		mV
Output Rise / Fall Time	Differential, 20% - 80%		19 / 18		ps

Information furnished by Analog Devices is believed to be accurate and reliable. However, no responsibility is assumed by Analog Devices for its use, nor for any infringements of patents or other rights of third parties that may result from its use. Specifications subject to change without notice. No license is granted by implication or otherwise under any patent or patent rights of Analog Devices. Trademarks and registered trademarks are the property of their respective owners.

For price, delivery, and to place orders: Analog Devices, Inc., One Technology Way, P.O. Box 9106, Norwood, MA 02062-9106  
Phone: 781-329-4700 • Order online at [www.analog.com](http://www.analog.com)  
Application Support: Phone: 1-800-ANALOG-D



## 14 Gbps, FAST RISE TIME XOR / XNOR GATE

### Electrical Specifications (continued)

Parameter	Conditions	Min.	Typ.	Max.	Units
Output Return Loss	Frequency <14 GHz		10		dB
Small Signal Gain			27		dB
Random Jitter Jr	rms			0.2	ps rms
Deterministic Jitter, Jd	peak-to-peak, 2 <sup>15</sup> -1 PRBS input [1]		2		ps, p-p
Propagation Delay, td			105		ps

[1] Deterministic jitter calculated by simultaneously measuring the jitter of a 300 mV, 13 GHz, 2<sup>15</sup>-1 PRBS input, and a single-ended output

#### DC Current vs. Supply Voltage [1]

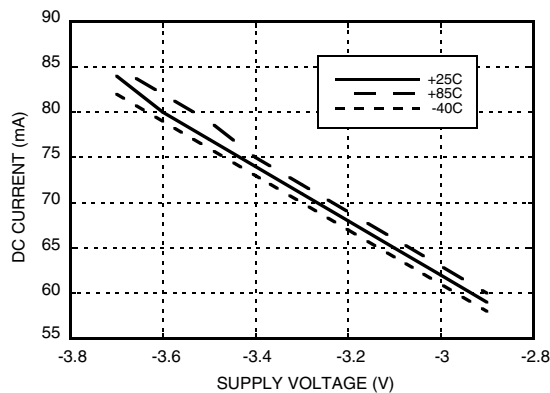

#### Output Differential Voltage vs. Supply Voltage [2]

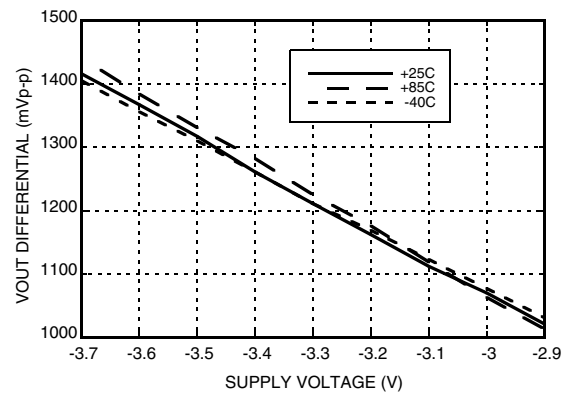

#### Output Differential Voltage vs. Frequency [3]

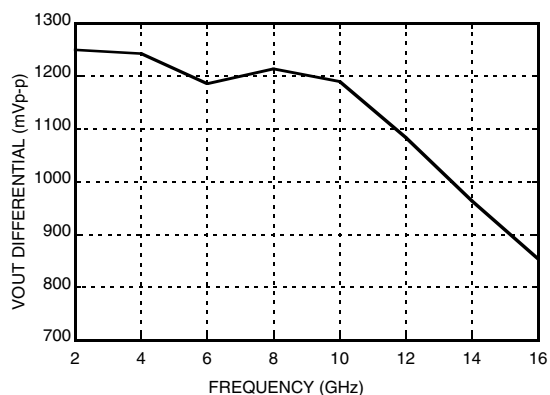

#### Rise / Fall Time vs. Supply [1]

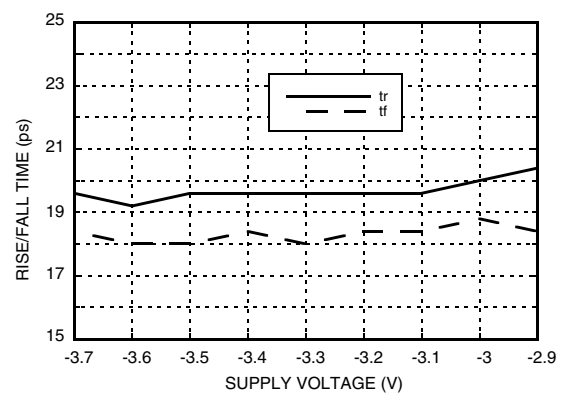

[1] Data rate = 13 Gbps

[2] Frequency = 10 GHz

[3] Vee = -3.3 V



**14 Gbps, FAST RISE TIME  
XOR / XNOR GATE**

**Output Return Loss vs. Frequency**

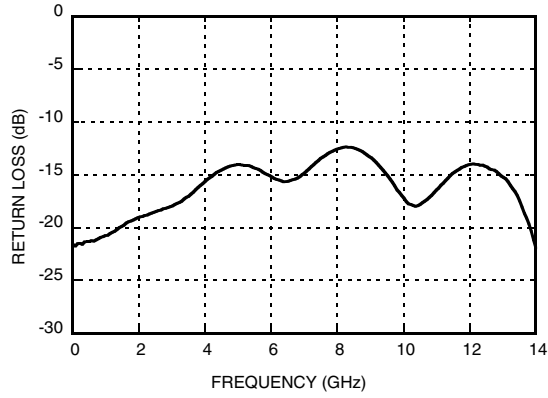

**Input Return Loss vs. Frequency**

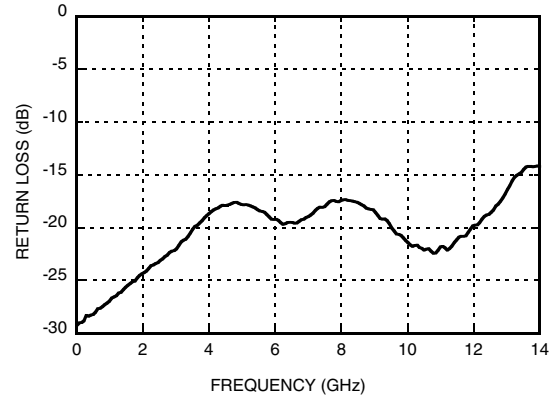

Information furnished by Analog Devices is believed to be accurate and reliable. However, no responsibility is assumed by Analog Devices for its use, nor for any infringements of patents or other rights of third parties that may result from its use. Specifications subject to change without notice. No license is granted by implication or otherwise under any patent or patent rights of Analog Devices. Trademarks and registered trademarks are the property of their respective owners.

For price, delivery, and to place orders: Analog Devices, Inc., One Technology Way, P.O. Box 9106, Norwood, MA 02062-9106 Phone: 781-329-4700 • Order online at [www.analog.com](http://www.analog.com) Application Support: Phone: 1-800-ANALOG-D



**14 Gbps, FAST RISE TIME  
XOR / XNOR GATE**

**Eye Diagram**

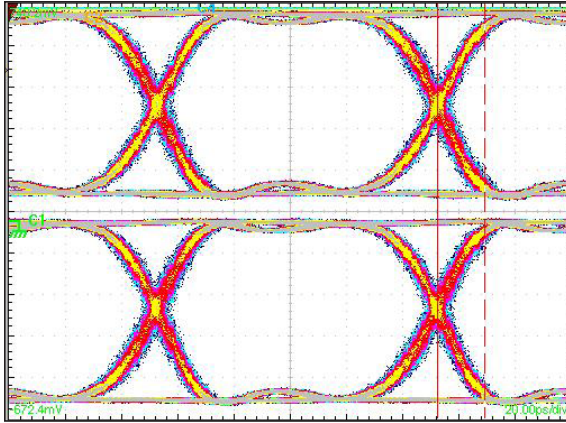

[1] Test Conditions:  
 Pattern generated with an Agilent N4903A Serial BERT.  
 Eye Diagram presented on a Tektronix CSA 8000.  
 Device input = 10 Gbps PN code,  $V_{in} = 300$  mVp-p differential.  
 Both output channels shown.

**Timing Diagram**

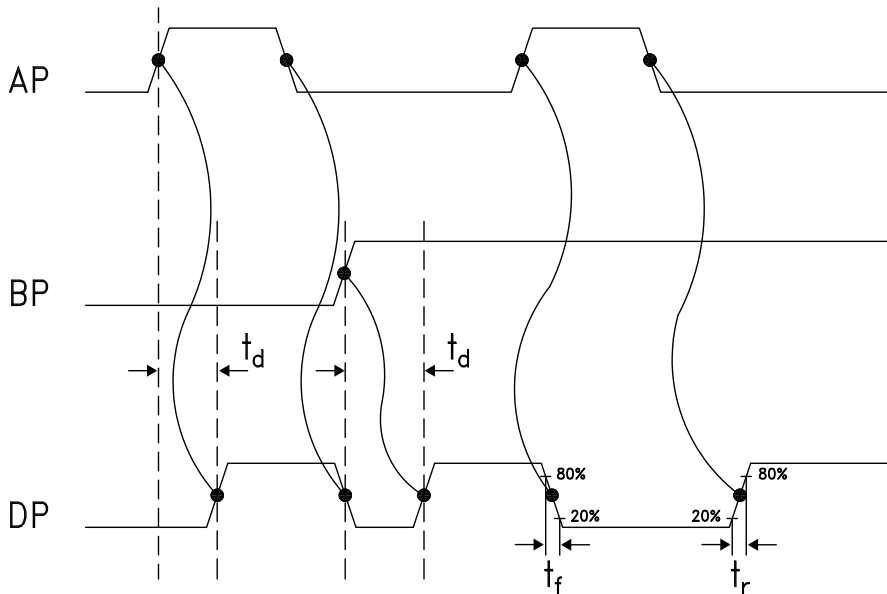

**Truth Table**

Input		Outputs
A	B	D
L	L	L
L	H	H
H	L	H
H	H	L

Notes:  
 A = AP - AN  
 B = BP - BN  
 D = DP - DN

H - Positive voltage level  
 L - Negative voltage level



## 14 Gbps, FAST RISE TIME XOR / XNOR GATE

### Absolute Maximum Ratings

Power Supply Voltage (Vee)	-3.75 V to +0.5 V
Input Signals	-2 V to +0.5 V
Output Signals	-1.5 V to +1 V
Continuous Pdiss (T = 85 °C) (derate 17 mW/°C above 85 °C)	0.68 W
Thermal Resistance (R <sub>th j-p</sub> ) Worst case junction to package paddle	59 °C/W
Maximum Junction Temperature	125 °C
Storage Temperature	-65 °C to +150 °C
Operating Temperature	-40 °C to +85 °C
ESD Sensitivity (HBM)	Class 1C



ELECTROSTATIC SENSITIVE DEVICE  
OBSERVE HANDLING PRECAUTIONS

### Outline Drawing

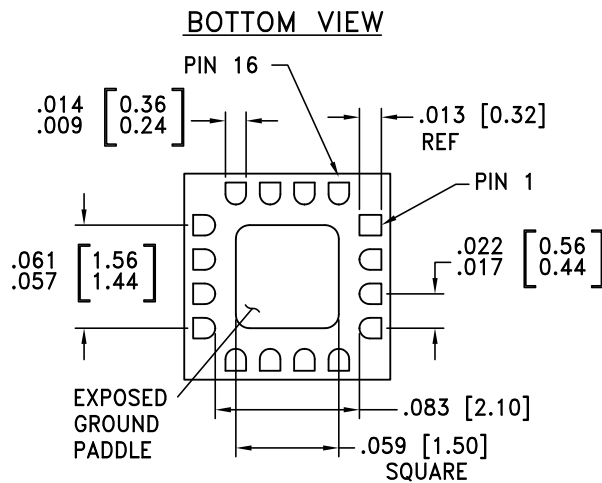
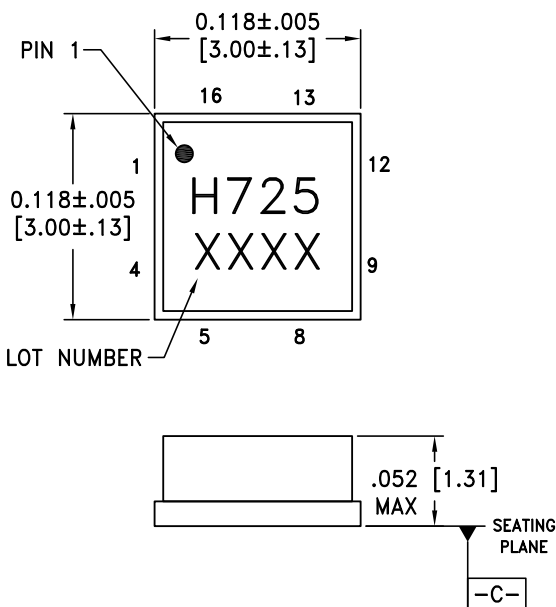

#### NOTES:

1. PACKAGE BODY MATERIAL: ALUMINA
2. LEAD AND GROUND PADDLE PLATING:  
30-80 MICROINCHES GOLD OVER 50 MICROINCHES MINIMUM NICKEL.
3. DIMENSIONS ARE IN INCHES [MILLIMETERS].
4. LEAD SPACING TOLERANCE IS NON-CUMULATIVE.
5. PACKAGE WARP SHALL NOT EXCEED 0.05 mm DATUM -C-
6. ALL GROUND LEADS MUST BE SOLDERED TO PCB RF GROUND.
7. PADDLE MUST BE SOLDERED TO GND.



### Package Information

Part Number	Package Body Material	Lead Finish	MSL Rating	Package Marking <sup>[2]</sup>
HMC725LC3C	Alumina, White	Gold over Nickel	MSL3 <sup>[1]</sup>	H725 XXXX

[1] Max peak reflow temperature of 260 °C

[2] 4-Digit lot number XXXX

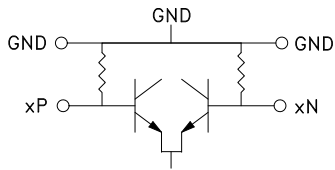
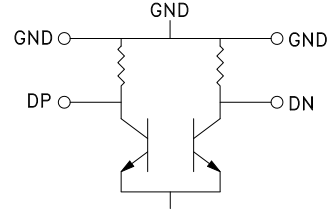
**14 Gbps, FAST RISE TIME  
XOR / XNOR GATE**
**Pin Descriptions**

Pin Number	Function	Description	Interface Schematic
1, 4, 5, 8, 9, 12	GND	These pins must be connected to a high-quality RF/DC ground.	
2, 3 6, 7	AN, AP BP, BN	Differential Data Inputs, Current Mode Logic (CML) referenced to positive supply.	
10, 11	DN, DP	Differential Data Outputs, Current Mode Logic (CML) referenced to positive supply	
13, 16	Vee	Negative Supply	
14, Package Base	GND	Supply Ground	
15	N/C	No Connection required. This pin may be connected to RF/DC ground without affecting performance.	

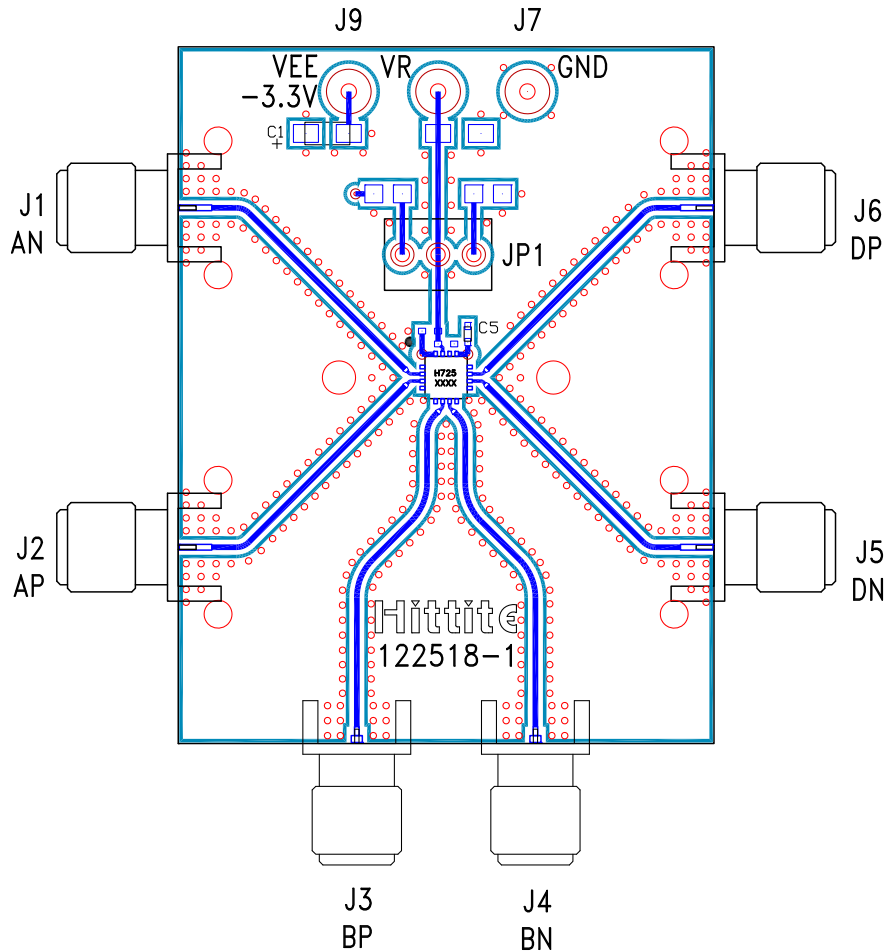
**14 Gbps, FAST RISE TIME  
XOR / XNOR GATE**
**Evaluation PCB**

**List of Materials for Evaluation PCB 122520 [1]**

Item	Description
J1 - J6	PCB Mount SMA RF Connectors
J7, J9	DC Pin
C1	4.7 $\mu$ F Capacitor, Tantalum
C5	100 pF Capacitor, 0402 Pkg.
U1	HMC725LC3C High Speed Logic, XOR / XNOR
PCB [2]	122518 Evaluation Board

[1] Reference this number when ordering complete evaluation PCB

[2] Circuit Board Material: Arlon 25FR or Rogers 4350

The circuit board used in the application should use RF circuit design techniques. Signal lines should have 50 Ohm impedance while the package ground leads should be connected directly to the ground plane similar to that shown. The exposed package base should be connected to GND. A sufficient number of via holes should be used to connect the top and bottom ground planes. The evaluation circuit board shown is available from Hittite upon request.



**14 Gbps, FAST RISE TIME  
XOR / XNOR GATE**

**Application Circuit**

