



RF360 Europe GmbH

A Qualcomm – TDK Joint Venture

SAW Components

GPS/GLONASS Extractor Filter

Automotive telematics

Series/type:	B4340
Ordering code:	B39162B4340P810
Date:	August 13, 2014
Version:	2.0

RF360 products mentioned within this document are offered by RF360 Europe GmbH and other subsidiaries of RF360 Holdings Singapore Pte. Ltd. (collectively, the “RF360 Subsidiaries”). RF360 Holdings Singapore Pte. Ltd. is a joint venture of Qualcomm Global Trading Pte. Ltd. and EPCOS AG. References in this documentation to EPCOS AG should properly reference, and shall be read to reference, the RF360 Subsidiaries.

RF360 Europe GmbH, Anzinger Str. 13, München, Germany

© 2016 RF360 Europe GmbH and/or its affiliated companies. All rights reserved.

These materials, including the information contained herein, may be used only for informational purposes by the customer. The RF360 Subsidiaries assume no responsibility for errors or omissions in these materials or the information contained herein. The RF360 Subsidiaries reserve the right to make changes to the product(s) or information contained herein without notice. The materials and information are provided on an AS IS basis, and the RF360 Subsidiaries assume no liability and make no warranty or representation, either expressed or implied, with respect to the materials, or any output or results based on the use, application, or evaluation of such materials, including, without limitation, with respect to the non-infringement of trademarks, patents, copyrights or any other intellectual property rights or other rights of third parties.

No use of this documentation or any information contained herein grants any license, whether express, implied, by estoppel or otherwise, to any intellectual property rights, including, without limitation, to any patents owned by QUALCOMM Incorporated or any of its subsidiaries.

Not to be used, copied, reproduced, or modified in whole or in part, nor its contents revealed in any manner to others without the express written permission of RF360 Europe GmbH.

Qualcomm and Qualcomm RF360 are trademarks of Qualcomm Incorporated, registered in the United States and other countries. RF360 is a trademark of Qualcomm Incorporated. Other product and brand names may be trademarks or registered trademarks of their respective owners.

This technical data may be subject to U.S. and international export, re-export, or transfer ("export") laws. Diversion contrary to U.S. and international law is strictly prohibited.



SAW Components

GPS/GLONASS Extractor Filter

Automotive telematics

Series/type:	B4340
Ordering code:	B39162B4340P810
Date:	August 13, 2014
Version:	2.0

© EPCOS AG 2015. Reproduction, publication and dissemination of this publication, enclosures hereto and the information contained therein without EPCOS' prior express consent is prohibited.

EPCOS AG is a TDK Group Company.

Data sheet

Application

- Low loss GPS/GLONASS Extractor
- Using common antenna for GPS/GLONASS and NON-GPS/GLONASS bands (Cellular, PCS, WCD-MA bands)
- Low insertion attenuation in GPS/GLONASS and NON-GPS/GLONASS bands
- Low amplitude ripple
- Low group delay ripple

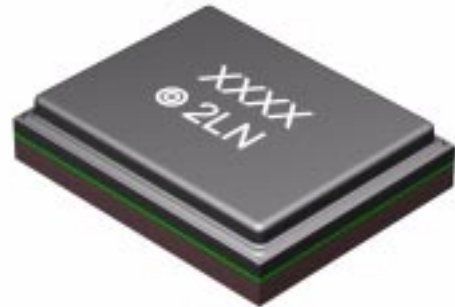
Features

- Package size 2.0 x 1.6 mm²
- Package height max. 0.45 mm
- RoHS compatible
- Approximate weight 0.005 g
- Package for **Surface Mount Technology (SMT)**
- Ni, Au-plated terminals
- **Electrostatic Sensitive Device (ESD)**
- AEC-Q200 qualified component family (operable temperature range of -40 °C to +85 °C)

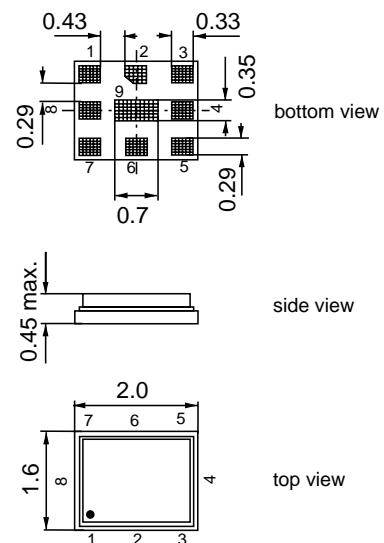
Pin configuration

- 6 ANT input
- 1 GPS/GLONASS output
- 3 NON-GPS/GLONASS output
- 2, 4, 5, 7, 8, 9 To be grounded

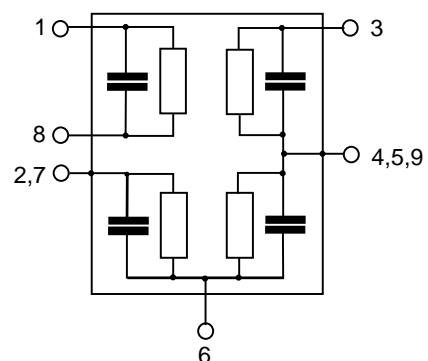

Data sheet

Characteristics

Temperature range for specification:	$T = -40\text{ °C to }+85\text{ °C}$
GPS/GLONASS terminating impedance:	$Z_{\text{GPGL}} = 50\ \Omega$
ANT terminating impedance:	$Z_{\text{ANT}} = 50\ \Omega \parallel 6.8\text{ nH}$
NON-GPS/GLONASS terminating impedance:	$Z_{\text{NON}} = 50\ \Omega + 3.3\text{ nH and } \parallel 1.3\text{ pF}$

Characteristics GPS/GLONASS		min.	typ. @ 25 °C	max.	
Maximum insertion attenuation					
	α_{max}				
1574.42 ... 1576.42 MHz		—	1.6	2.4	dB
1565.42 ... 1585.42 MHz		—	2.1	3.3	dB
1597.55 ... 1605.89 MHz		—	2.4	3.3	dB
Amplitude ripple (p-p)					
	$\Delta\alpha$				
1574.42 ... 1576.42 MHz		—	0.4	1.1	dB
1565.42 ... 1585.42 MHz		—	0.8	2.2	dB
1597.55 ... 1605.89 MHz		—	0.8	2.2	dB
Group delay ripple¹⁾ (p-p)					
	$\Delta\tau$				
1597.55 ... 1605.89 MHz		—	4	—	ns
VSWR (Antenna port)					
1574.42 ... 1576.42 MHz		—	1.7	2.0	
1565.42 ... 1585.42 MHz		—	1.5	2.0	
1597.55 ... 1605.89 MHz		—	1.5	2.0	
VSWR (GPS/GLONASS port)					
1574.42 ... 1576.42 MHz		—	1.5	2.0	
1565.42 ... 1585.42 MHz		—	1.4	2.0	
1597.55 ... 1605.89 MHz		—	1.4	2.0	
Attenuation ANT-GPS/GLONASS					
	α				
50.0 ... 824.0 MHz		31	34	—	dB
824.0 ... 960.0 MHz		33	36	—	dB
1427.9 ... 1510.9 MHz		35	41	—	dB
1710.0 ... 1995.0 MHz		35	39	—	dB
2110.0 ... 2170.0 MHz		35	40	—	dB
2400.0 ... 2500.0 MHz		35	40	—	dB
2500.0 ... 2690.0 MHz		35	40	—	dB

1) Measured with an aperture of 2 MHz

Data sheet

Characteristics

Temperature range for specification:	$T = -40\text{ °C to }+85\text{ °C}$
GPS/GLONASS terminating impedance:	$Z_{\text{GPGL}} = 50\ \Omega$
ANT terminating impedance:	$Z_{\text{ANT}} = 50\ \Omega \parallel 6.8\text{ nH}$
NON-GPS/GLONASS terminating impedance:	$Z_{\text{NON}} = 50\ \Omega + 3.3\text{ nH and } \parallel 1.3\text{ pF}$

Characteristics NON-GPS/GLONASS				min.	typ. @ 25 °C	max.	
Maximum insertion attenuation							
			α_{max}				
	704.0	... 824.0	MHz	—	1.0	1.6	dB
	824.0	... 960.0	MHz	—	0.9	1.3	dB
	1427.9	... 1462.9	MHz	—	0.9	1.2	dB
	1475.9	... 1510.9	MHz	—	1.0	1.3	dB
	1710.0	... 1995.0	MHz	—	1.4	1.8	dB
	2110.0	... 2170.0	MHz	—	1.4	1.8	dB
	2400.0	... 2483.5	MHz	—	1.0	1.4	dB
	2500.0	... 2690.0	MHz	—	0.9	1.2	dB
VSWR (Antenna port)							
	704.0	... 824.0	MHz	—	1.5	2.0	
	824.0	... 960.0	MHz	—	1.5	2.0	
	1427.9	... 1462.9	MHz	—	1.8	2.4	
	1475.9	... 1510.9	MHz	—	1.9	2.3	
	1710.0	... 1995.0	MHz	—	1.7	2.0	
	2110.0	... 2170.0	MHz	—	1.7	2.0	
	2400.0	... 2483.5	MHz	—	1.5	1.9	
	2500.0	... 2690.0	MHz	—	1.5	2.0	
VSWR (NON-GPS/GLONASS port)							
	704.0	... 824.0	MHz	—	1.7	2.0	
	824.0	... 960.0	MHz	—	1.7	2.0	
	1427.9	... 1462.9	MHz	—	1.7	2.4	
	1475.9	... 1510.9	MHz	—	1.8	2.3	
	1710.0	... 1995.0	MHz	—	1.8	2.1	
	2110.0	... 2170.0	MHz	—	1.8	2.1	
	2400.0	... 2483.5	MHz	—	1.5	1.9	
	2500.0	... 2690.0	MHz	—	1.5	2.0	

Data sheet

Characteristics

Temperature range for specification: $T = -40\text{ °C to }+85\text{ °C}$
 GPS/GLONASS terminating impedance: $Z_{\text{GPGL}} = 50\ \Omega$
 ANT terminating impedance: $Z_{\text{ANT}} = 50\ \Omega \parallel 6.8\text{ nH}$
 NON-GPS/GLONASS terminating impedance: $Z_{\text{NON}} = 50\ \Omega + 3.3\text{ nH and } \parallel 1.3\text{ pF}$

Isolation between NON and GPS/GLONASS				min.	typ. @ 25 °C	max.	
704.0	...	824.0	MHz	33	35	—	dB
824.0	...	960.0	MHz	33	36	—	dB
1427.9	...	1510.9	MHz	35	40	—	dB
1710.0	...	1995.0	MHz	35	40	—	dB
2110.0	...	2170.0	MHz	35	40	—	dB
2400.0	...	2483.5	MHz	35	40	—	dB
2500.0	...	2690.0	MHz	35	40	—	dB

Maximum rating

Operable temperature range	T	-40/+85	°C	
Storage temperature range	T _{stg}	-40/+85	°C	
DC voltage	V _{DC}	0	V	
Input power				
704.00 ... 915.00 MHz	P _{IN}	31	dBm	effective power in the on-state
1427.9 ... 1462.9 MHz	P _{IN}	31	dBm	effective power in the on-state
1710.0 ... 2690.0 MHz	P _{IN}	31	dBm	effective power in the on-state



ANT - GPS/GLONASS (transfer function passband)

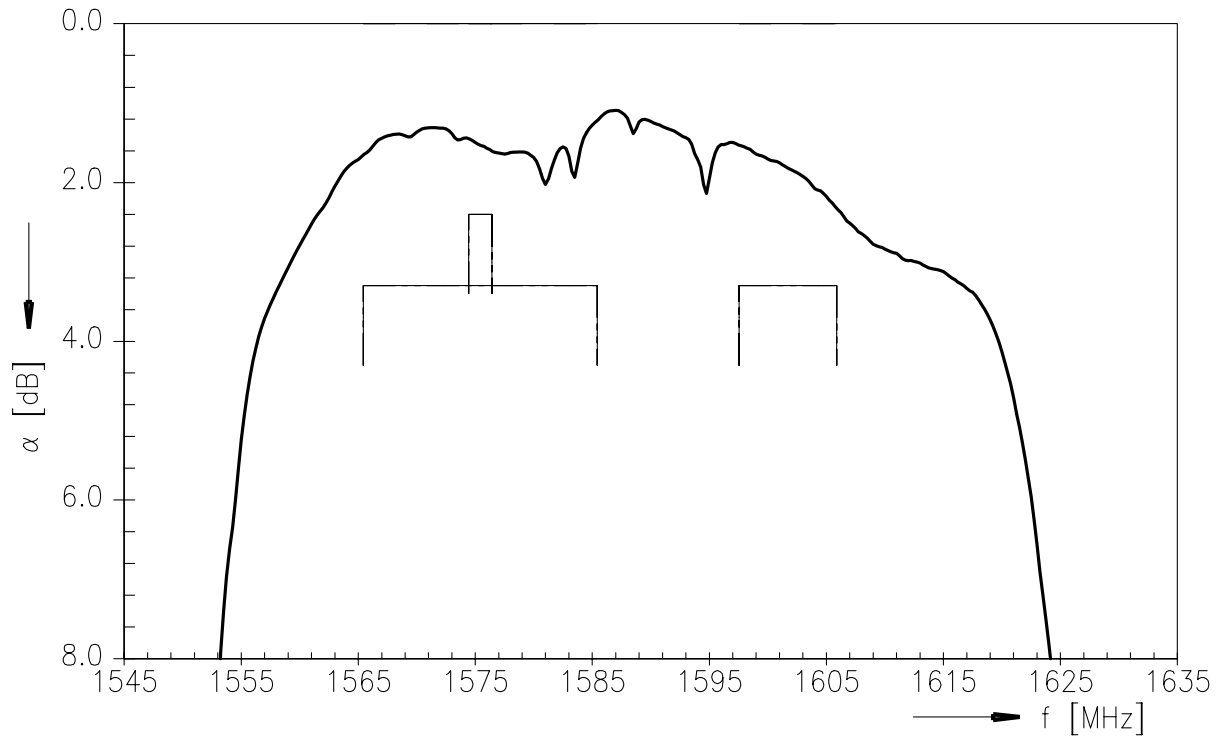

ANT - GPS/GLONASS (transfer function wideband)

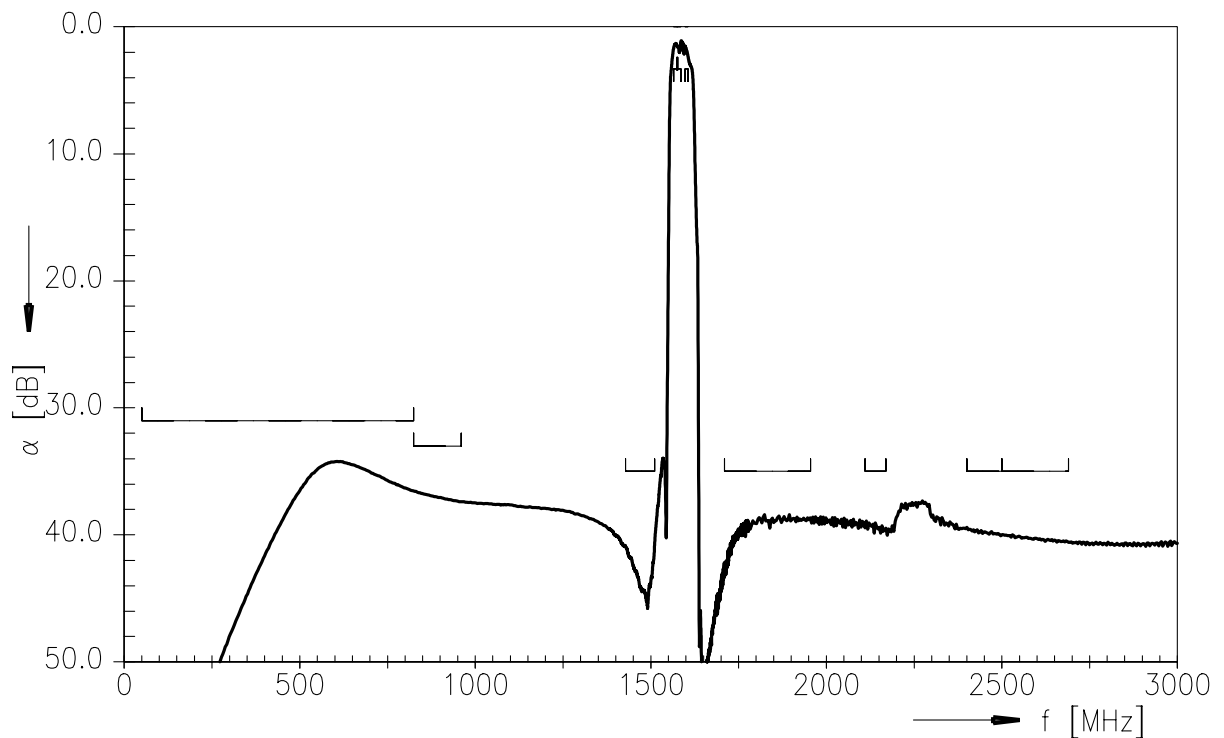

Data sheet



ANT - NON (transfer function)

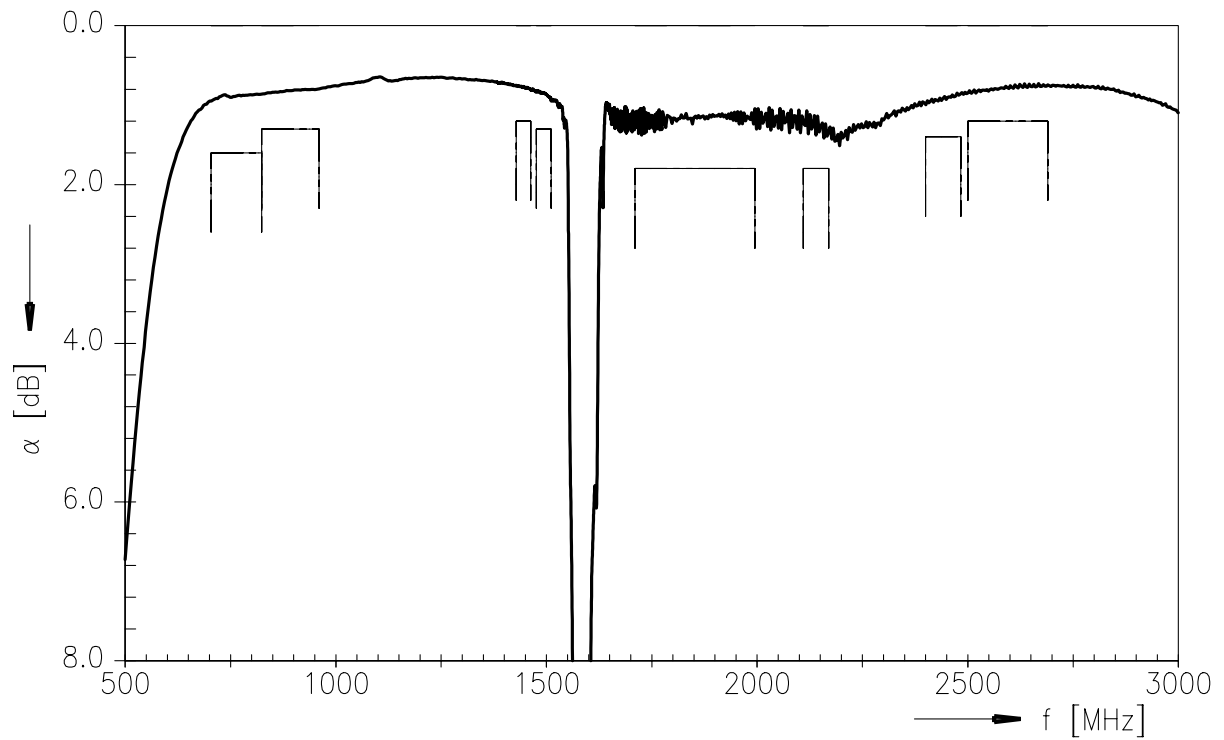

GPS - NON (isolation, transfer function)

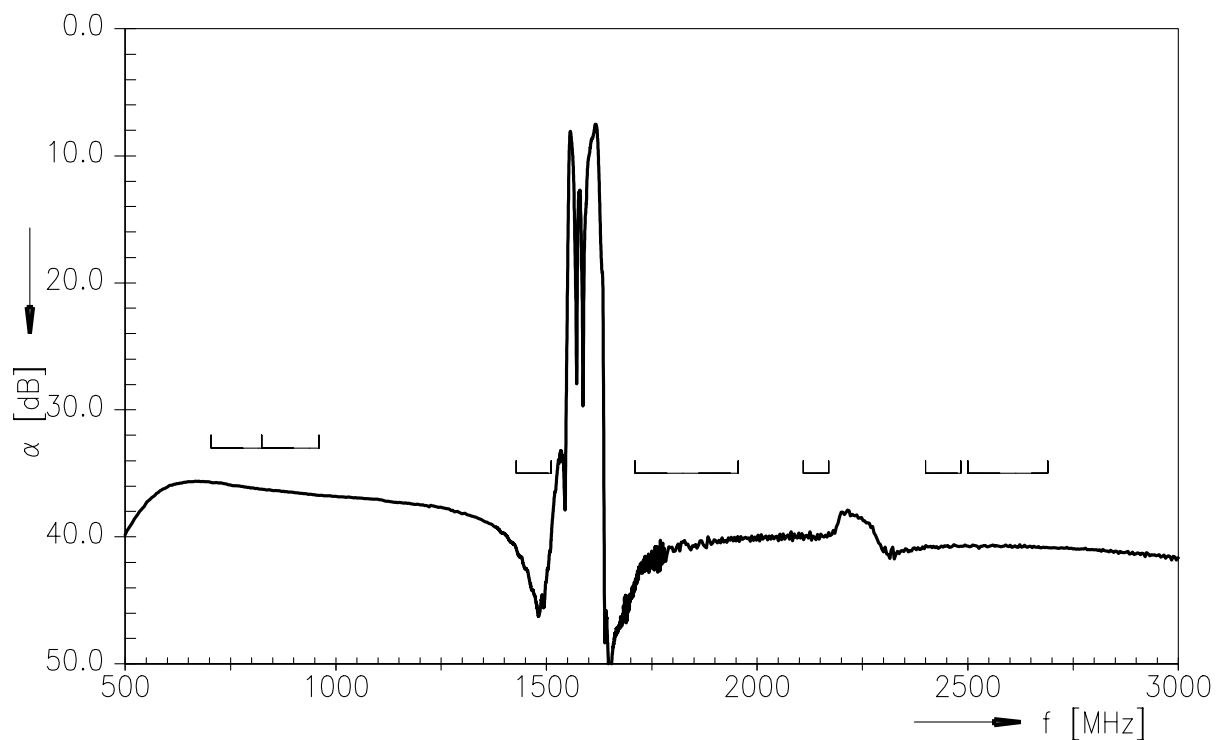

Data sheet



Smith chart

S₁₁ ANT

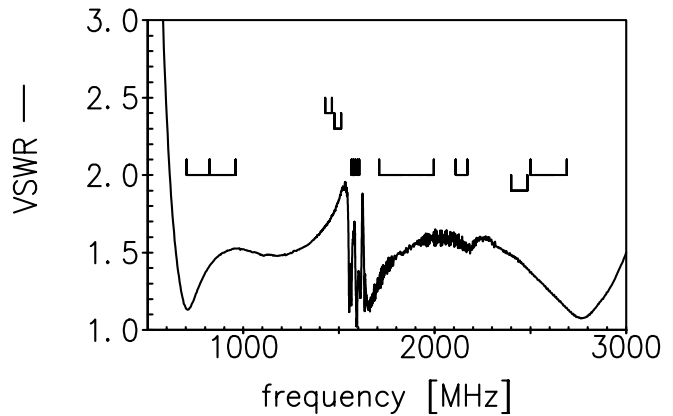
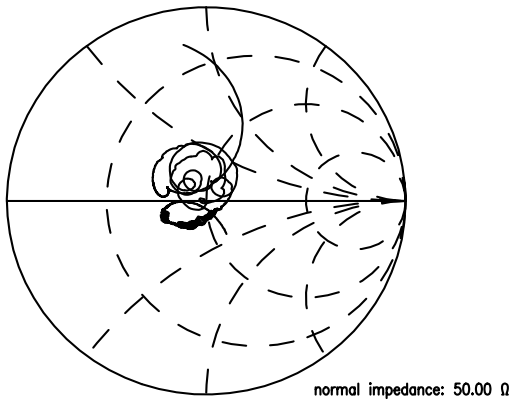

S₂₂ GPS/GLONASS

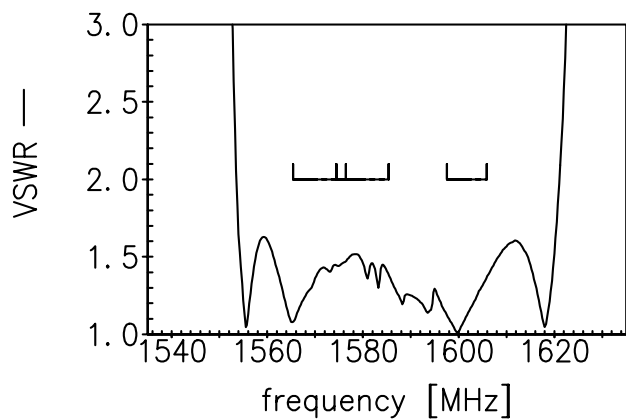
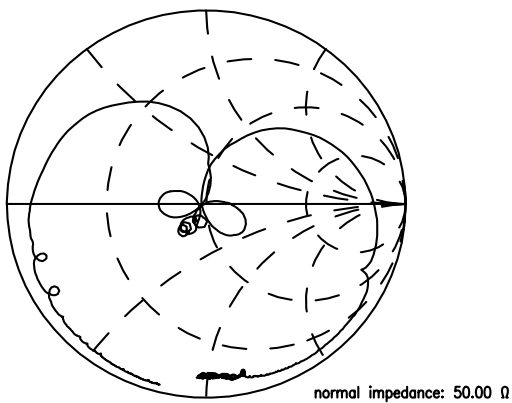

S₃₃ NON

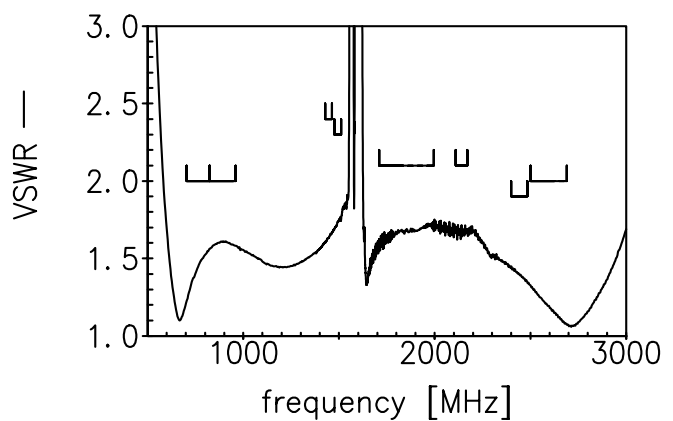
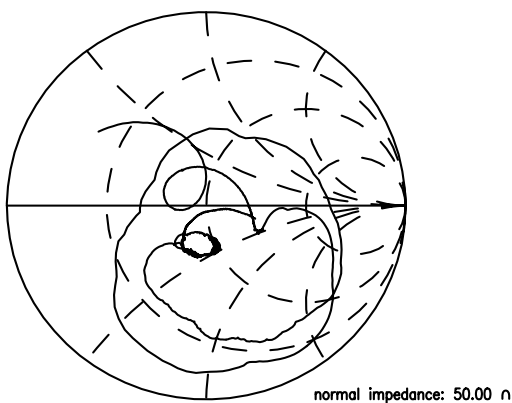



ESD protection of SAW filters

SAW filters are **E**lectro **S**tatic **D**ischarge sensitive devices. To reduce the probability of damages caused by ESD, special matching topologies have to be applied.

In general, “ESD matching” has to be ensured at that filter port, where electrostatic discharge is expected.

Electrostatic discharges predominantly appear at the antenna input of RF receivers. Therefore only the input matching of the SAW filter has to be designed to short circuit or to block the ESD pulse.

Below three figures show recommended “ESD matching” topologies.

For wideband filters the high-pass ESD matching structure needs to be at least of 3rd order to ensure a proper matching for any impedance value of antenna and SAW filter input. The required component values have to be determined from case to case.

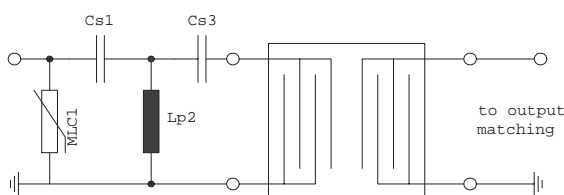

Fig. 1 MLC varistor plus ESD matching

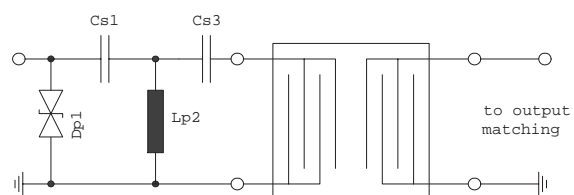

Fig. 2 Suppressor diode plus ESD matching

In cases where minor ESD occur, following simplified “ESD matching” topologies can be used alternatively.

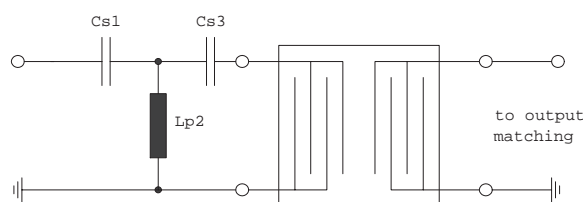

Fig. 3 3rd order high-pass structure for basic ESD protection

In all three figures the shunt inductor Lp2 could be replaced by a shorted microstrip with proper length and width. If this configuration is possible depends on the operating frequency and available pcb space.

Effectiveness of the applied ESD protection has to be checked according to relevant industry standards or customer specific requirements

For further information, please refer to EPCOS Application report:

“ESD protection for SAW filters”.

This report can be found under www.epcos.com/rke. Click on “Applications Notes”.

References

Type	B4340
Ordering code	B39162B4340P810
Marking and package	C61157-A8-A37
Packaging	F61074-V8247-Z000
Date codes	L_1126
S-parameters	B4340_NB_UN.s3p, B4340_WB_UN.s3p See file header for port/pin assignment.
Soldering profile	S_6001
RoHS compatible	RoHS-compatible means that products are compatible with the requirements according to Art. 4 (substance restrictions) of Directive 2011/65/EU of the European Parliament and of the Council of June 8 th , 2011, on the restriction of the use of certain hazardous substances in electrical and electronic equipment ("Directive") with due regard to the application of exemptions as per Annex III of the Directive in certain cases.
Moldability	Before using in overmolding environment, please contact your EPCOS sales office.
Matching coils	See Inductor pdf-catalog http://www.tdk.co.jp/tefe02/coil.htm#aname1 and Data Library for circuit simulation http://www.tdk.co.jp/etvcl/index.htm for a large variety of matching coils.

For further information please contact your local EPCOS sales office or visit our webpage at www.epcos.com.

Published by EPCOS AG
Systems, Acoustics, Waves Business Group
P.O. Box 80 17 09, 81617 Munich, GERMANY

© EPCOS AG 2014. This brochure replaces the previous edition.

For questions on technology, prices and delivery please contact the Sales Offices of EPCOS AG or the international Representatives.

Due to technical requirements components may contain dangerous substances. For information on the type in question please also contact one of our Sales Offices.

Important notes

The following applies to all products named in this publication:

1. Some parts of this publication contain **statements about the suitability of our products for certain areas of application**. These statements are based on our knowledge of typical requirements that are often placed on our products in the areas of application concerned. We nevertheless expressly point out **that such statements cannot be regarded as binding statements about the suitability of our products for a particular customer application**. As a rule, EPCOS is either unfamiliar with individual customer applications or less familiar with them than the customers themselves. For these reasons, it is always ultimately incumbent on the customer to check and decide whether an EPCOS product with the properties described in the product specification is suitable for use in a particular customer application.
2. We also point out that **in individual cases, a malfunction of electronic components or failure before the end of their usual service life cannot be completely ruled out in the current state of the art, even if they are operated as specified**. In customer applications requiring a very high level of operational safety and especially in customer applications in which the malfunction or failure of an electronic component could endanger human life or health (e.g. in accident prevention or life-saving systems), it must therefore be ensured by means of suitable design of the customer application or other action taken by the customer (e.g. installation of protective circuitry or redundancy) that no injury or damage is sustained by third parties in the event of malfunction or failure of an electronic component.
3. **The warnings, cautions and product-specific notes must be observed.**
4. In order to satisfy certain technical requirements, **some of the products described in this publication may contain substances subject to restrictions in certain jurisdictions (e.g. because they are classed as hazardous)**. Useful information on this will be found in our Material Data Sheets on the Internet (www.epcos.com/material). Should you have any more detailed questions, please contact our sales offices.
5. We constantly strive to improve our products. Consequently, **the products described in this publication may change from time to time**. The same is true of the corresponding product specifications. Please check therefore to what extent product descriptions and specifications contained in this publication are still applicable before or when you place an order. We also **reserve the right to discontinue production and delivery of products**. Consequently, we cannot guarantee that all products named in this publication will always be available. The aforementioned does not apply in the case of individual agreements deviating from the foregoing for customer-specific products.
6. Unless otherwise agreed in individual contracts, **all orders are subject to the current version of the “General Terms of Delivery for Products and Services in the Electrical Industry” published by the German Electrical and Electronics Industry Association (ZVEI)**.
7. The trade names EPCOS, BAOKE, Alu-X, CeraDiode, CeraLink, CeraPlas, CSMP, CSSP, CTVS, DeltaCap, DigiSiMic, DSSP, FilterCap, FormFit, MiniBlue, MiniCell, MKD, MKK, MLSC, MotorCap, PCC, PhaseCap, PhaseCube, PhaseMod, PhiCap, SIFERRIT, SIFI, SIKOREL, SilverCap, SIMDAD, SiMic, SIMID, SineFormer, SIOV, SIP5D, SIP5K, TFAP, ThermoFuse, WindCap are **trademarks registered or pending** in Europe and in other countries. Further information will be found on the Internet at www.epcos.com/trademarks.

Mouser Electronics

Authorized Distributor

Click to View Pricing, Inventory, Delivery & Lifecycle Information:

[Qualcomm RF360:](#)

[B39162B4340P810](#)