

THIS DRAWING IS UNPUBLISHED. RELEASED FOR PUBLICATION, 19 .
 © COPYRIGHT 19 BY AMP INCORPORATED. ALL RIGHTS RESERVED.

LOC	DIST	REVISIONS			
P	LTR	DESCRIPTION	DATE	DWN	APVD
BD	36	W	REDRAWN PER EC 0020-1178-94	14 JUL 95	-

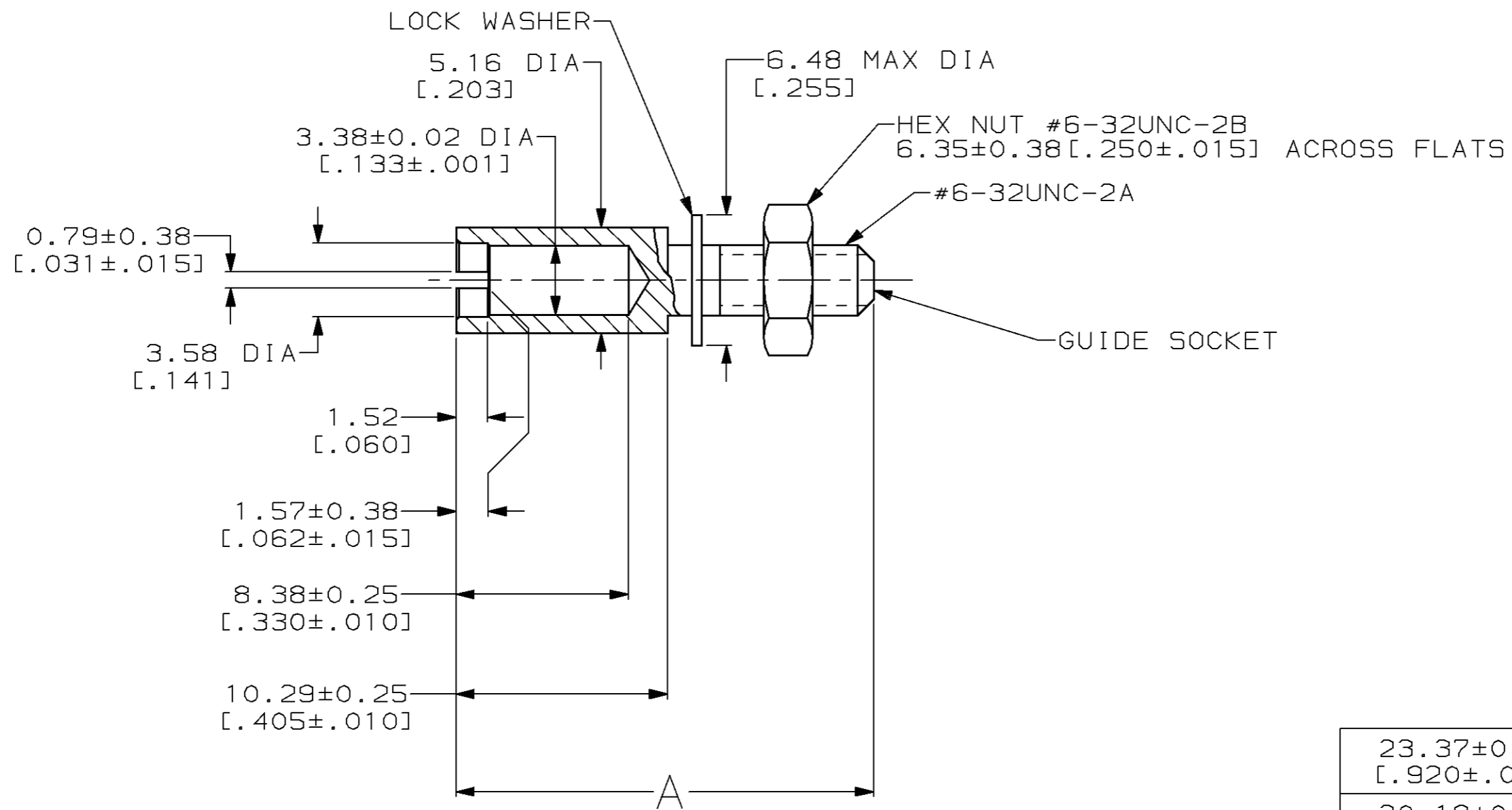

ASSEMBLED VIEW

23.37±0.25 [.920±.010]	201047-7
20.19±0.25 [.795±.010]	201047-2
A	PART NUMBER

- ① GUIDE SOCKET: STAINLESS STEEL.
LOCK WASHER: STAINLESS STEEL.
HEX NUT: CRS.
- ② HEX NUT: ZINC PLATED.

THIS DRAWING IS A CONTROLLED DOCUMENT FOR AMP INCORPORATED. IT IS SUBJECT TO CHANGE AND THE CONTROLLING ENGINEERING ORGANIZATION SHOULD BE CONTACTED FOR THE LATEST REVISION.		DWN C. REIFSNYDER 14 JUL 95	AMP Incorporated Harrisburg, PA 17105-3608												
DIMENSIONS: mm [INCHES]		CHK R. STONE 17 JUL 95													
TOLERANCES UNLESS OTHERWISE SPECIFIED:		APVD G. STEINHAEUER 20 SEP 95													
<table border="1"> <tr><td>0 PLC</td><td>±-</td></tr> <tr><td>1 PLC</td><td>±-</td></tr> <tr><td>2 PLC</td><td>±0.13 [.005]</td></tr> <tr><td>3 PLC</td><td>±-</td></tr> <tr><td>4 PLC</td><td>±-</td></tr> <tr><td>ANGLES</td><td>±-</td></tr> </table>		0 PLC	±-	1 PLC	±-	2 PLC	±0.13 [.005]	3 PLC	±-	4 PLC	±-	ANGLES	±-	PRODUCT SPEC -	NAME GUIDE SOCKET KIT, UNASSEMBLED RECTANGULAR, MINIATURE, CORNER, COMPLETE, M SERIES
0 PLC	±-														
1 PLC	±-														
2 PLC	±0.13 [.005]														
3 PLC	±-														
4 PLC	±-														
ANGLES	±-														
MATERIAL ①	FINISH ②	APPLICATION SPEC -	SIZE A3												
		WEIGHT -	CAGE CODE 00779												
		CUSTOMER DRAWING	DRAWING NO C-201047												
		SCALE 4:1	SHEET 1 OF 1												
			REV W												