

# Altech UL489 Busbar Systems



## UL489 Listed Busbars

The Altech Busbar System is an innovative way to jumper up to 57 poles of Miniature Circuit Breakers (MCB).

The advantages of this busbar system are:

- 30% Installation time savings
- Panel space savings
- Reduced maintenance
- High electrical ratings

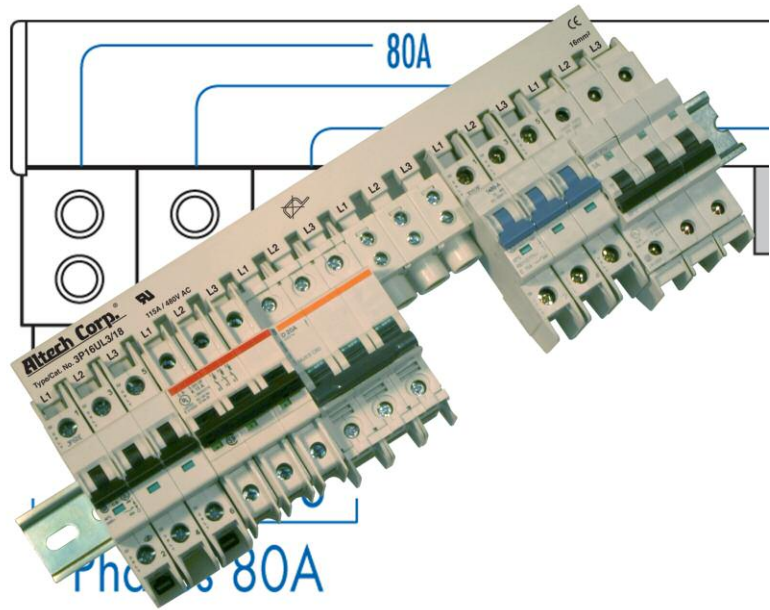

**Universal UL489 Busbar fits most UL489 Miniature Circuit Breakers in the market!**

*Please contact Altech for details and further information.*

## UL489 Busbar System

- Every pin configuration is possible by combination of existing 6, 12 and 18 pin busbars.
- Power Feeding:  
Power Feed Lug (115A), Direct Power Feed (115A)
- UL listed for Altech's L-Series of Miniature Circuit Breakers
- UL listed for use with most popular UL489 Miniature Circuit Breakers in the market.

Technical Specifications	Busbars UL489
Material of Busbar	Copper
Material of Insulation (Housing)	Polyamid
Electrical Ratings	115A/480VAC
Short Circuit Withstand Rating	10kA
Applying Standards	UL489, VDE0660 Part 100, IEC60749, DIN EN60947-1

# Altech UL489 Busbar System

## Power Feed Methods

### End Feed Method

#### P35ULT\*

With the **P35ULT** Power Feed Lug as a Start/End Feeding Device a maximum input current of **115A per Phase** can be achieved.

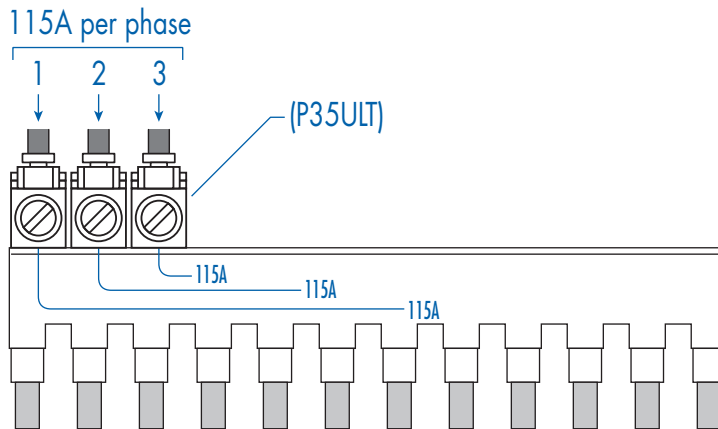

#### P50ULB\*

With the **P50ULB** Modular Direct Power Feed as a Start/End Feeding Device a maximum input current of **115A per Phase** can be achieved.

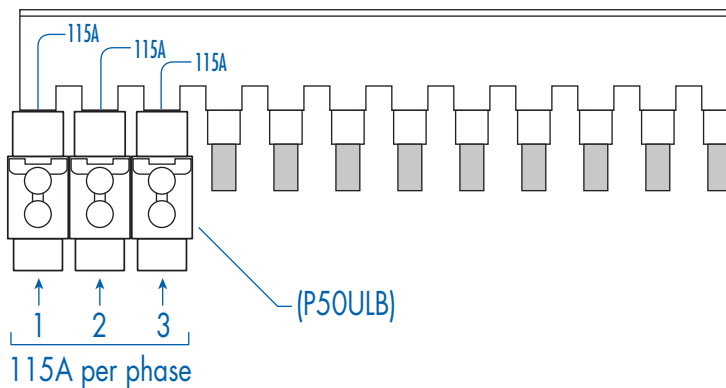

\* For complete specifications and description of Feeding Devices see page 19.

# 1 PHASE BUSBAR

16mm<sup>2</sup> for 115A



UL489 recognized  
E305318  
CE

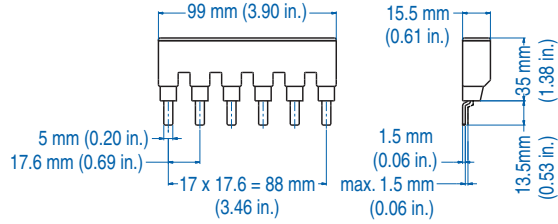

Type/ Cat. No.	No. of Pins	Length [mm]
1P16UL3/6	6	99

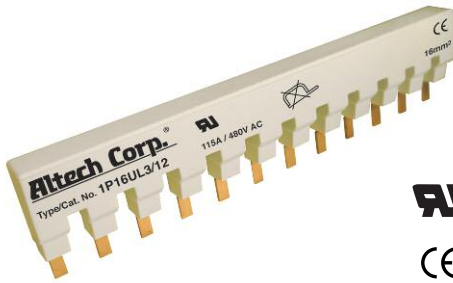

UL489 recognized  
E305318  
CE

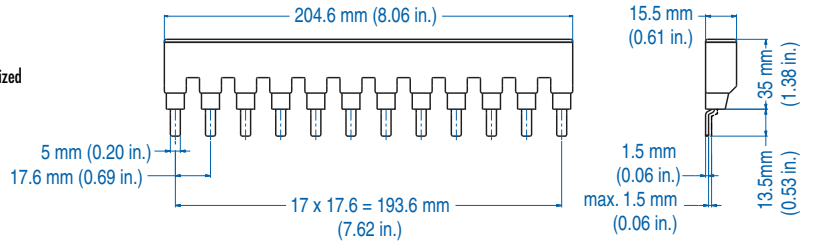

Type/ Cat. No.	No. of Pins	Length [mm]
1P16UL3/12	12	204.6

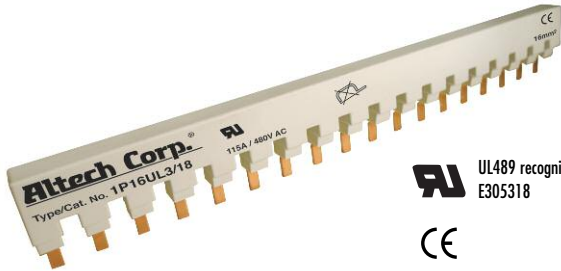

UL489 recognized  
E305318  
CE

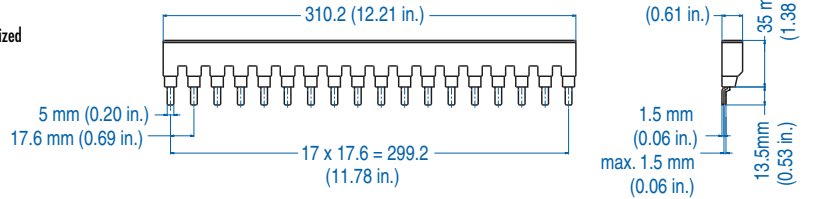

Type/ Cat. No.	No. of Pins	Length [mm]
1P16UL3/18	18	310.2

### Example for different No. of Pins

eg. 44 pins use 1x 1P16UL3/12 + 2x 1P16UL3/18

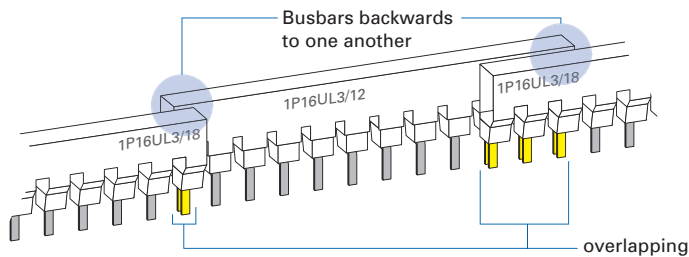

- No. of overlapping pins of 2 busbars must be a multiplier of the No. of phases
- Overlapping busbars are backwards to each other

## ACCESSORIES



Type/Cat. No: **P35ULT**  
Description: Power Feed Lug



Type/Cat. No: **P50ULB**  
Description: Modular Direct Power Feed



Type/Cat. No: **BRUL (3 per strip)**  
Description: Insulation Cap

## 2 PHASE BUSBAR

16mm<sup>2</sup> for 115A

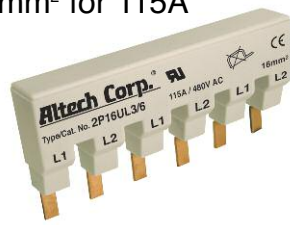

**UL489 recognized**  
E305318

**CE**

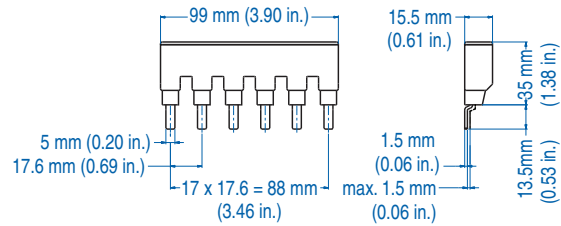

Type/ Cat. No.	No. of Pins	Length [mm]
2P16UL3/6	6	99

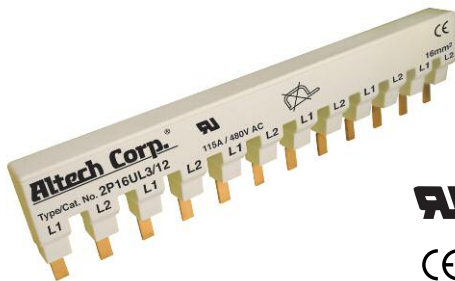

**UL489 recognized**  
E305318

**CE**

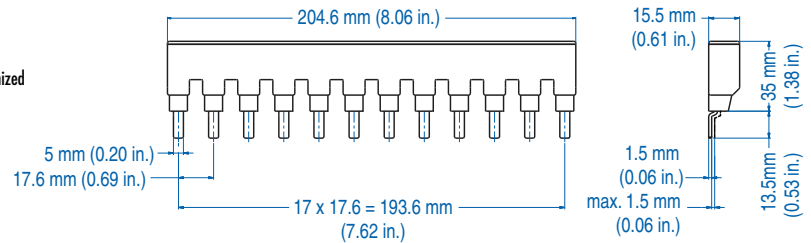

Type/ Cat. No.	No. of Pins	Length [mm]
2P16UL3/12	12	204.6

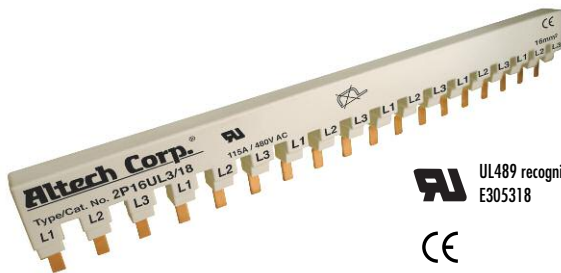

**UL489 recognized**  
E305318

**CE**

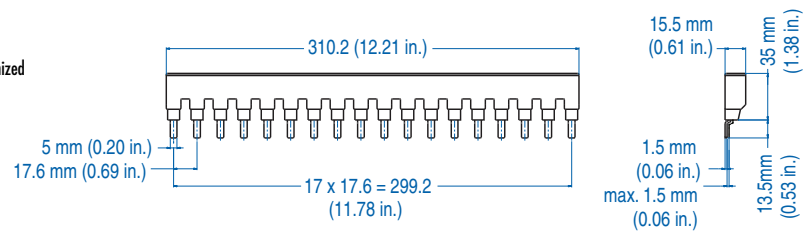

Type/ Cat. No.	No. of Pins	Length [mm]
2P16UL3/18	18	310.2

### Example for different No. of Pins

eg. 30 pins use 3x 2P16UL3/12

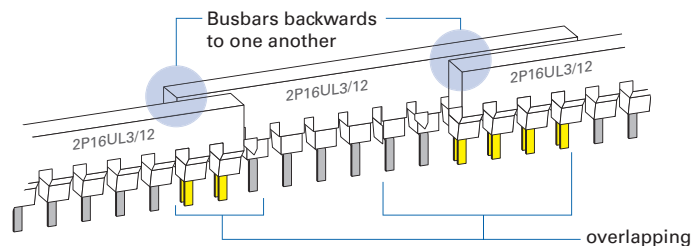

- No. of overlapping pins of 2 busbars must be multiplier of the No. of phases
- Overlapping busbars are backwards to each other

## ACCESSORIES



Type/Cat. No: **P35ULT**  
Description: Power Feed Lug



Type/Cat. No: **P50ULB**  
Description: Modular Direct Power Feed



Type/Cat. No: **BRUL (3 per strip)**  
Description: Insulation Cap

# 3 PHASE BUSBAR

16mm<sup>2</sup> for 115A

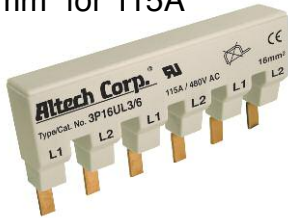

**UL** UL489 listed  
E305318  
**CE**

Type/  
Cat. No.                      No. of  
Pins                              Length  
[mm]

3P16UL3/6                      6                              99

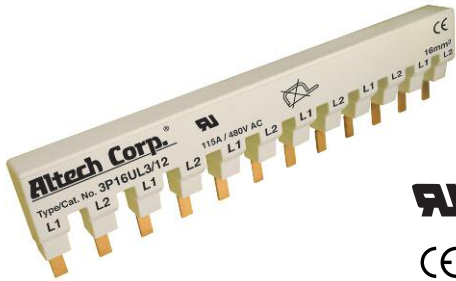
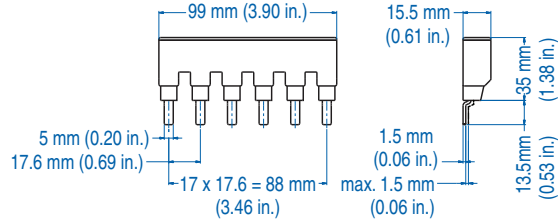

**UL** UL489 listed  
E305318  
**CE**

Type/  
Cat. No.                      No. of  
Pins                              Length  
[mm]

3P16UL3/12                      12                              204.6

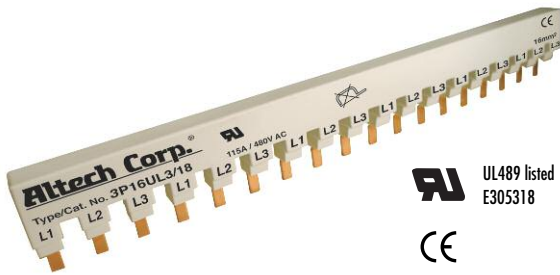
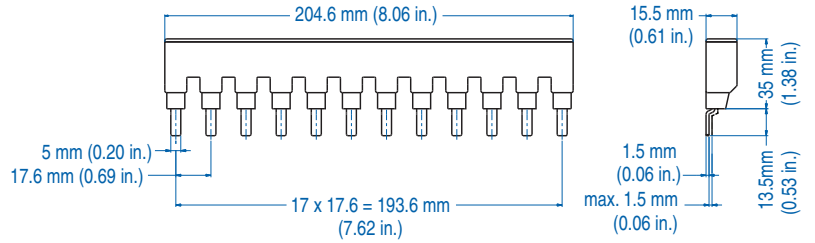

**UL** UL489 listed  
E305318  
**CE**

Type/  
Cat. No.                      No. of  
Pins                              Length  
[mm]

3P16UL3/18                      18                              310.2

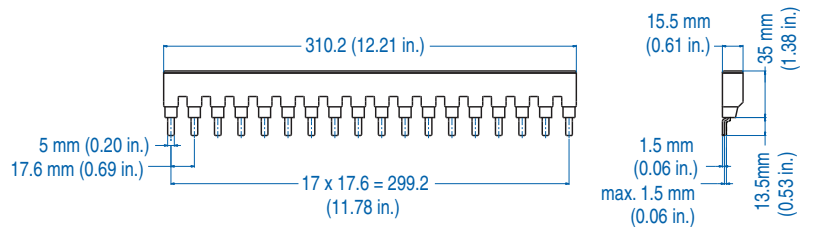

### Example for different No. of Pins

eg. 39 pins use 1x 3P16UL3/12 + 2x 3P16UL3/18

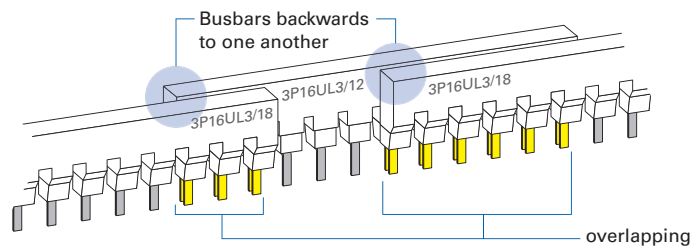

- No. of overlapping pins of 2 busbars must be multiplier of the No. of phases
- Overlapping busbars are backwards to each other

## ACCESSORIES



Type/Cat. No:                      **P35ULT**  
Description:                      Power Feed Lug



Type/Cat. No:                      **P50ULB**  
Description:                      Modular Direct Power Feed



Type/Cat. No:                      **BRUL (3 per strip)**  
Description:                      Insulation Cap

## Power Feed Devices

Easy connection of power supply wires to the busbar/MCB. Power Feed Devices ensure permanent connection.

### Power Feed Lug



UL489 listed  
E305318  
CE

### Modular Direct Power Feed



UL489 listed  
E305318  
CE

Type/Cat. No.	P35ULT	P50ULB
Electrical Ratings	115A/480V AC	115A/480V AC
Conductors	75 C°	75 C°
Terminal Site Acceptability	14-2AWG(1.53mm <sup>2</sup> )	14-1AWG(1.5-50mm <sup>2</sup> )
Required Torque	4Nm (35.4 lb. in.)	3.5Nm/31 lb. in. (14-6AWG) 4Nm/35.4 lb. in. (4-1AWG)
Material of Lug	Brass	Brass
Insulation Material	Polyamid	Polyamid
For use with	UL489 1-3 phase Busbar	UL489 1-3 phase Busbar

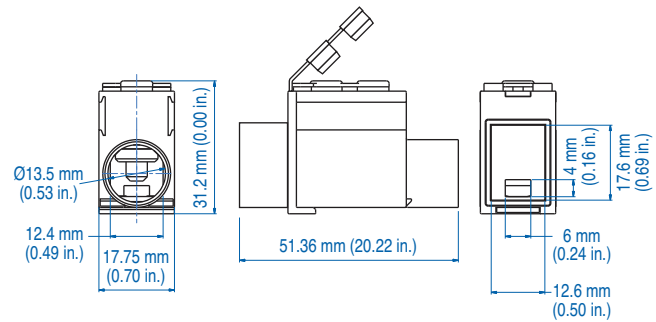
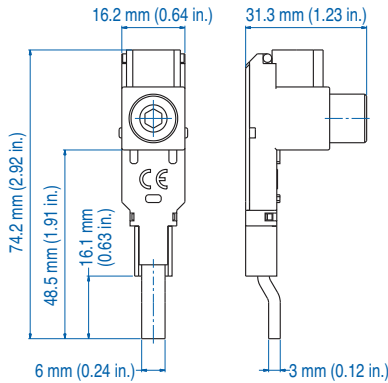

## Assembly Instructions

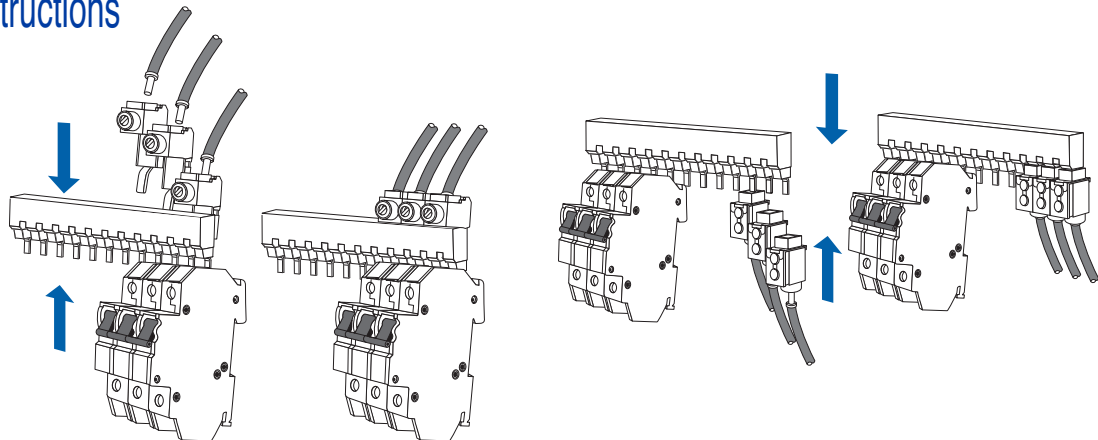

## Miscellaneous Accessories

### Insulation Caps



Type/Cat. No:  
Description:

BRUL (3 per strip)  
Insulation Cap



# Altech Busbar Systems

## Configuration and Assembly of UL489 Busbars

UL489 Busbars are available in 3 different Pin Configurations per Phase, (6, 12 and 18 Pins).

The UL489 busbar cannot be cut, since the creepage and clearance distance requirements from UL are too stringent. Therefore, to obtain the desired No. of Pins, Busbar-Pins can be overlapped as explained below:

- 1) Busbars are overlapped backwards to each other. Both Pins of each Busbar fit together in the terminals of the Minature Circuit Breaker.
- 2) The Number of overlapping Pins of 2 Busbar must be a multiplier of the Number of Phases to keep existing Phase sequence. (Can be overlapped by more than the number of phases).
- 3) Any available combination of the 3 different Pin configurations is possible.
- 4) In most cases there is more than 1 combination possible.
- 5) For more possible configurations see Busbar Selection Table on page 21.

### Configuration Examples\*

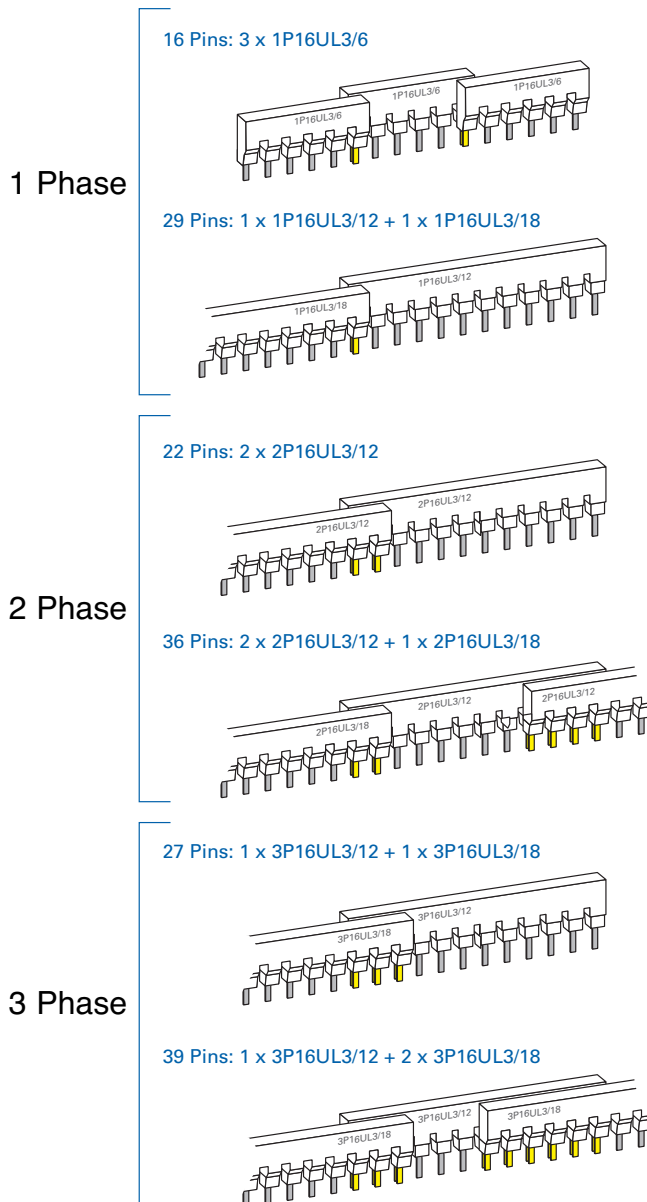

\*For Questions, other configurations and detailed information please contact Altech Corp.

# Busbar Selection Table

No. of Pins	Necessary Busbars	No. of Pins	Necessary Busbars	No. of Pins	Necessary Busbars	No. of Pins	Necessary Busbars
<b>1 Phase System</b>							
6	1x 1P16UL3/6	27	2x 1P16UL3/18 1x 1P16UL3/12 + 1x 1P16UL3/18	43	1x 1P16UL3/12 + 2x 1P16UL3/18 3x 1P16UL3/18	38	1x 2P16UL3/6 + 2x 2P16UL3/18 3x 2P16UL3/18
7	2x 1P16UL3/6		2x 1P16UL3/6 + 1x 1P16UL3/18	44	1x 1P16UL3/12 + 2x 1P16UL3/18 3x 1P16UL3/18		2x 2P16UL3/12 + 1x 2P16UL3/18 1x 2P16UL3/12 + 2x 2P16UL3/18
8	2x 1P16UL3/6		3x 1P16UL3/12			40	3x 2P16UL3/18 1x 2P16UL3/12 + 2x 2P16UL3/18
9	2x 1P16UL3/6	28	2x 1P16UL3/18 1x 1P16UL3/12 + 1x 1P16UL3/18	45	1x 1P16UL3/12 + 2x 1P16UL3/18 3x 1P16UL3/18	42	3x 2P16UL3/18 1x 2P16UL3/12 + 2x 2P16UL3/18
10	2x 1P16UL3/6		2x 1P16UL3/6 + 1x 1P16UL3/18	46	1x 1P16UL3/12 + 2x 1P16UL3/18 3x 1P16UL3/18	44	3x 2P16UL3/18 1x 2P16UL3/12 + 2x 2P16UL3/18
11	2x 1P16UL3/6		3x 1P16UL3/12	47	3x 1P16UL3/18	46	3x 2P16UL3/18
12	1x 1P16UL3/12 3x 1P16UL3/6	29	2x 1P16UL3/18 1x 1P16UL3/12 + 1x 1P16UL3/18	48	3x 1P16UL3/18	48	3x 2P16UL3/18
13	2x 1P16UL3/12 3x 1P16UL3/6 1x 1P16UL3/6 + 1x 1P16UL3/12	30	2x 1P16UL3/18 3x 1P16UL3/12 1x 1P16UL3/6 + 1x 1P16UL3/12 + 1x 1P16UL3/18	49	3x 1P16UL3/18	50	3x 2P16UL3/18
14	2x 1P16UL3/12 3x 1P16UL3/6 1x 1P16UL3/6 + 1x 1P16UL3/12			50	3x 1P16UL3/18		
15	2x 1P16UL3/12 3x 1P16UL3/6 1x 1P16UL3/6 + 1x 1P16UL3/12		2x 1P16UL3/12 + 1x 1P16UL3/18 1x 1P16UL3/12 + 2x 1P16UL3/18	51	3x 1P16UL3/18		
16	2x 1P16UL3/12 3x 1P16UL3/6 1x 1P16UL3/6 + 1x 1P16UL3/12	31	2x 1P16UL3/18 3x 1P16UL3/12 1x 1P16UL3/6 + 1x 1P16UL3/12 + 1x 1P16UL3/18	52	3x 1P16UL3/18	<b>3 Phase System</b>	
17	2x 1P16UL3/12 1x 1P16UL3/6 + 1x 1P16UL3/12		2x 1P16UL3/12 + 1x 1P16UL3/18 1x 1P16UL3/12 + 2x 1P16UL3/18	<b>2 Phase System</b>		9	2x 3P16UL3/6
18	1x 1P16UL3/18 2x 1P16UL3/12 2x 1P16UL3/6 + 1x 1P16UL3/12 1x 1P16UL3/6 + 2x 1P16UL3/12	32	2x 1P16UL3/18 3x 1P16UL3/12 1x 1P16UL3/6 + 1x 1P16UL3/12 + 1x 1P16UL3/18	6	1x 2P16UL3/6	12	1x 3P16UL3/12 3x 3P16UL3/6
19	2x 1P16UL3/12 2x 1P16UL3/18 2x 1P16UL3/6 + 1x 1P16UL3/12 1x 1P16UL3/6 + 2x 1P16UL3/12 1x 1P16UL3/6 + 1x 1P16UL3/18 1x 1P16UL3/12 + 1x 1P16UL3/18	33	2x 1P16UL3/18 3x 1P16UL3/12 1x 1P16UL3/6 + 1x 1P16UL3/12 + 1x 1P16UL3/18	8	2x 2P16UL3/6	15	1x 3P16UL3/6 + 1x 3P16UL3/12 2x 3P16UL3/12
20	2x 1P16UL3/12 2x 1P16UL3/18 1x 1P16UL3/6 + 2x 1P16UL3/12 2x 1P16UL3/6 + 1x 1P16UL3/12 1x 1P16UL3/6 + 1x 1P16UL3/18 1x 1P16UL3/12 + 1x 1P16UL3/18	34	2x 1P16UL3/18 3x 1P16UL3/12 1x 1P16UL3/6 + 1x 1P16UL3/12 + 1x 1P16UL3/18	10	2x 2P16UL3/6 1x 2P16UL3/12	18	1x 3P16UL3/18 1x 3P16UL3/12 + 2x 3P16UL3/6 2x 3P16UL3/12
21	2x 1P16UL3/12 2x 1P16UL3/18 2x 1P16UL3/6 + 1x 1P16UL3/12 1x 1P16UL3/6 + 2x 1P16UL3/12 1x 1P16UL3/6 + 1x 1P16UL3/18 1x 1P16UL3/12 + 1x 1P16UL3/18	35	2x 1P16UL3/18 3x 1P16UL3/12 1x 1P16UL3/6 + 1x 1P16UL3/12 + 1x 1P16UL3/18	12	3x 2P16UL3/6 1x 2P16UL3/12	21	2x 3P16UL3/12 1x 3P16UL3/6 + 1x 3P16UL3/18 1x 3P16UL3/12 + 1x 3P16UL3/18 2x 3P16UL3/18
22	2x 1P16UL3/12 2x 1P16UL3/18 2x 1P16UL3/6 + 1x 1P16UL3/12 1x 1P16UL3/6 + 2x 1P16UL3/12 1x 1P16UL3/6 + 1x 1P16UL3/18 1x 1P16UL3/12 + 1x 1P16UL3/18	36	2x 1P16UL3/18 3x 1P16UL3/12 1x 1P16UL3/6 + 1x 1P16UL3/12 + 1x 1P16UL3/18	14	3x 2P16UL3/6 2x 2P16UL3/12 1x 2P16UL3/6 + 1x 2P16UL3/12	24	1x 3P16UL3/12 + 1x 3P16UL3/18 2x 3P16UL3/6 + 1x 3P16UL3/18 1x 3P16UL3/6 + 2x 3P16UL3/12 3x 3P16UL3/18 2x 3P16UL3/18
23	2x 1P16UL3/12 2x 1P16UL3/18 1x 1P16UL3/6 + 1x 1P16UL3/18 1x 1P16UL3/12 + 1x 1P16UL3/18	37	2x 1P16UL3/18 3x 1P16UL3/12 1x 1P16UL3/6 + 1x 1P16UL3/12 + 1x 1P16UL3/18	16	2x 2P16UL3/12 1x 2P16UL3/6 + 1x 2P16UL3/12	27	1x 3P16UL3/12 + 1x 3P16UL3/18 2x 3P16UL3/18 3x 3P16UL3/12
24	2x 1P16UL3/12 2x 1P16UL3/18 1x 1P16UL3/12 + 1x 1P16UL3/18	38	2x 1P16UL3/18 3x 1P16UL3/12 1x 1P16UL3/6 + 1x 1P16UL3/12 + 1x 1P16UL3/18	18	1x 2P16UL3/18 2x 2P16UL3/12 2x 2P16UL3/6 + 1x 2P16UL3/12	30	2x 3P16UL3/18 2x 3P16UL3/12 + 1x 3P16UL3/18 3x 3P16UL3/12 1x 3P16UL3/6 + 1x 3P16UL3/12 + 1x 3P16UL3/18
25	2x 1P16UL3/12 2x 1P16UL3/18 1x 1P16UL3/12 + 1x 1P16UL3/18 2x 1P16UL3/6 + 1x 1P16UL3/18 3x 1P16UL3/12	39	2x 1P16UL3/18 3x 1P16UL3/12 1x 1P16UL3/6 + 1x 1P16UL3/12 + 1x 1P16UL3/18	20	2x 2P16UL3/6 + 1x 2P16UL3/12 1x 2P16UL3/6 + 1x 2P16UL3/18 2x 2P16UL3/12 2x 2P16UL3/18 1x 2P16UL3/12 + 1x 2P16UL3/18	33	2x 3P16UL3/18 2x 3P16UL3/12 + 1x 3P16UL3/18 3x 3P16UL3/12 1x 3P16UL3/6 + 1x 3P16UL3/18
26	2x 1P16UL3/18 1x 1P16UL3/12 + 1x 1P16UL3/18 2x 1P16UL3/6 + 1x 1P16UL3/18 3x 1P16UL3/12	40	2x 1P16UL3/18 3x 1P16UL3/12 1x 1P16UL3/6 + 1x 1P16UL3/12 + 1x 1P16UL3/18	22	2x 2P16UL3/12 2x 2P16UL3/18 1x 2P16UL3/6 + 1x 2P16UL3/18 1x 2P16UL3/12 + 1x 2P16UL3/18	36	1x 3P16UL3/6 + 2x 3P16UL3/18 2x 3P16UL3/12 + 1x 3P16UL3/18 1x 3P16UL3/12 + 2x 3P16UL3/18 3x 3P16UL3/18
		41	1x 1P16UL3/12 + 2x 1P16UL3/18 3x 1P16UL3/18	24	2x 2P16UL3/6 + 1x 2P16UL3/18 1x 2P16UL3/6 + 2x 2P16UL3/12 3x 2P16UL3/12 2x 2P16UL3/18	39	1x 3P16UL3/12 + 2x 3P16UL3/18 3x 3P16UL3/18
		42	1x 1P16UL3/12 + 2x 1P16UL3/18 3x 1P16UL3/18	26	2x 2P16UL3/6 + 1x 2P16UL3/18 1x 2P16UL3/6 + 2x 2P16UL3/12 3x 2P16UL3/12 2x 2P16UL3/18 1x 2P16UL3/12 + 1x 2P16UL3/18	42	1x 3P16UL3/12 + 2x 3P16UL3/18 3x 3P16UL3/18
				28	3x 2P16UL3/12 2x 2P16UL3/18 1x 2P16UL3/12 + 1x 2P16UL3/18	45	3x 3P16UL3/18
				30	1x 2P16UL3/6 + 1x 2P16UL3/12 + 1x 2P16UL3/18 3x 2P16UL3/12 2x 2P16UL3/12 + 1x 2P16UL3/18 2x 2P16UL3/18	48	3x 3P16UL3/18
				32	1x 2P16UL3/6 + 1x 2P16UL3/12 + 1x 2P16UL3/18 3x 2P16UL3/12 2x 2P16UL3/12 + 1x 2P16UL3/18 2x 2P16UL3/18		
				34	1x 2P16UL3/6 + 1x 2P16UL3/12 + 1x 2P16UL3/18 2x 2P16UL3/12 + 1x 2P16UL3/18 2x 2P16UL3/18		
				36	1x 2P16UL3/6 + 2x 2P16UL3/18 3x 2P16UL3/18 2x 2P16UL3/12 + 1x 2P16UL3/18 2x 2P16UL3/18		

Note: For detailed information and examples see page 20.