



A New Direction in Mixed-Signal

June 2012

XRP7714EVB-DEMO-X

Four Channel Digital PWM Demo Boards

Rev. 1.1.1

GENERAL DESCRIPTION

The XRP7714EVB-DEMO-1, XRP7714EVB-DEMO-2, and the XRP7714-DEMO-2P Demo boards are complete, working, four channel, power systems measuring either 2" x 2", or 2" by 2.5" capable of producing over 35 watts. They provide 3.3V, 2.5V 1.8V and 1V at a maximum of 4 amps per channel. The 2.5V, 1.8V and 1V supplies can be adjusted in 50mV increments, and the 3.3V supply is adjustable in 100mV increments. The order and ramp rates for each supply can be programmed to accommodate any sequencing requirement. All power supply operations can be controlled over an I²C interface. Faults, output voltages and currents can also be monitored. Four GPIO signals are available and can be programmed to provide status of power good signals enables and faults. Unused GPIO pins can be programmed as I/O expansion for a microcontroller. The board is supported by PowerArchitect™ and plugs directly onto the Exar Communications Module (XRP77XXEVB-XCM).

EVALUATION BOARD MANUAL



XRP7714EVB-DEMO-1 XRP7714EVB-DEMO-2/2P

FEATURES

- **XRP7714 Programmable Controller**
- **4 Channel Power System**
- **Wide Input Voltage Range: 4.5V-25V**
- **Over 35W Capable**
- **Small Form Factor: 2.0" x 2.0"**
- **I²C Interface**
 - Programming
 - Monitoring
 - Control

EVALUATION BOARD

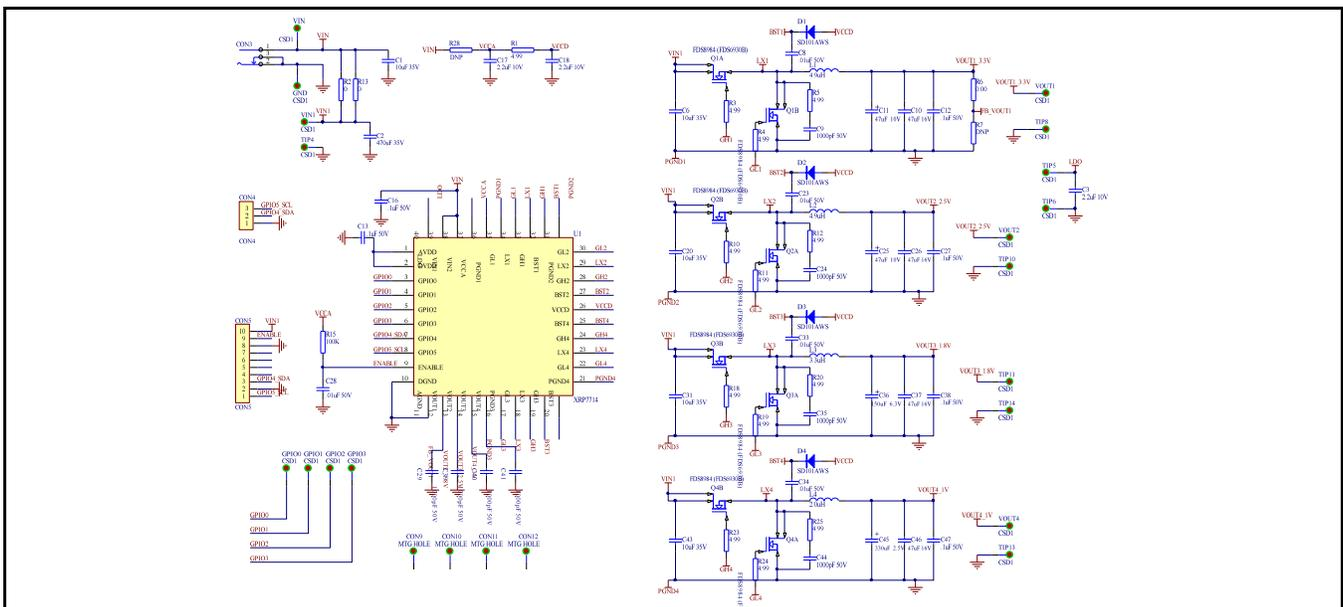

Fig. 1: XRP7714EVB-DEMO-X2/2P Schematic

PIN ASSIGNMENT

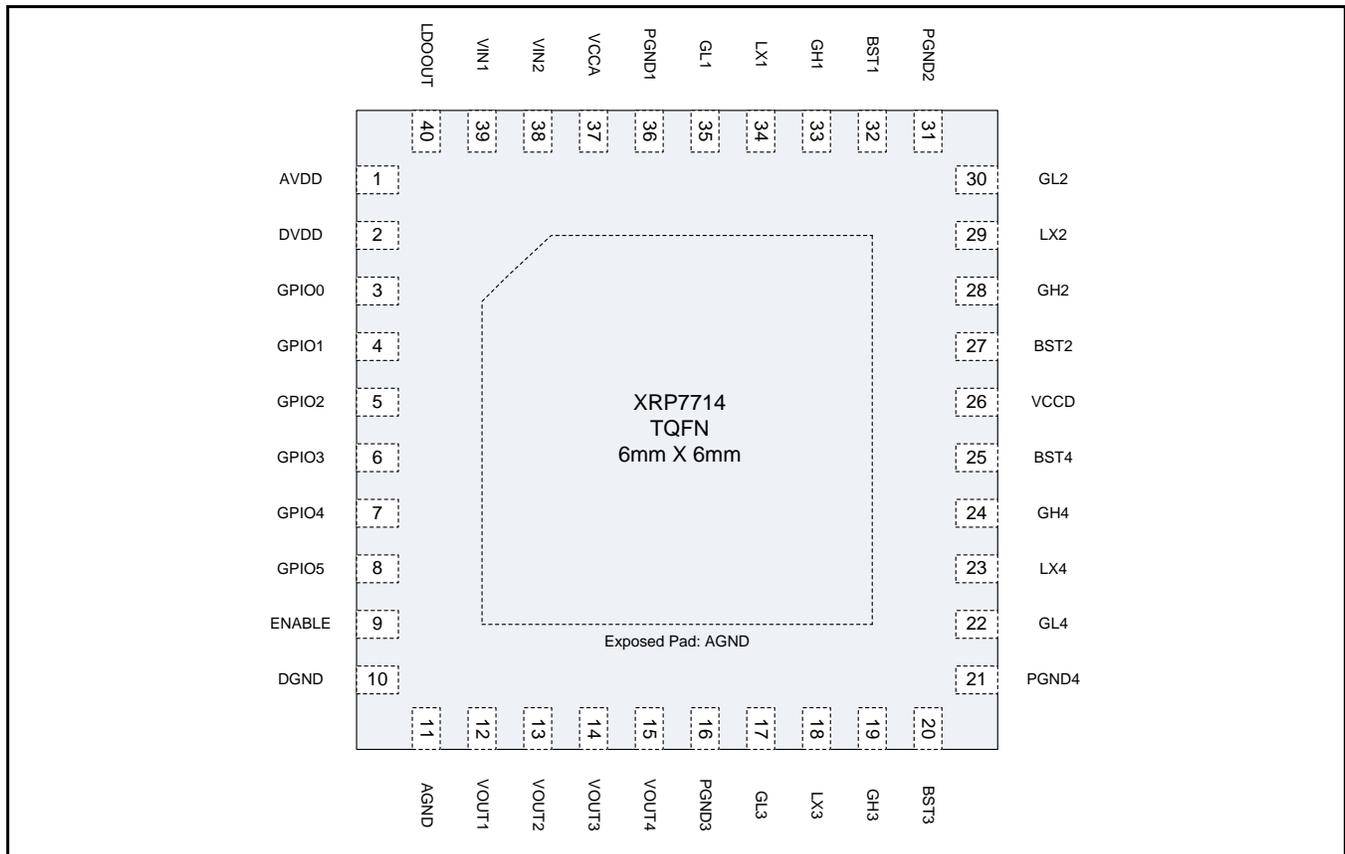

Fig. 2: XRP7714EVB-DEMO-X Pin Assignment

Pin Description

| Name | Pin Number | Description |
|---------|-------------|--|
| VIN1 | 39 | Power source for the internal linear regulators to generate VCCA, VDD and the Standby LDO (LDOOUT). Place a decoupling capacitor close to the controller IC. Also used in UVLO1 fault generation – if VIN1 falls below the user programmed limit, all channels are shut down. The VIN1 pin needs to be tied to VIN2 on the board with a short trace. |
| VIN2 | 38 | If the Vin2 pin voltage falls below the user programmed UVLO VIN2 level all channels are shut down. The VIN2 pin needs to be tied to VIN1 on the board with a short trace. |
| VCCA | 37 | Output of the internal 5V LDO. This voltage is internally used to power analog blocks. Note that a compensation capacitor should be used on this pin (see application note). |
| VCCD | 26 | Gate Drive input voltage. This is not an output voltage. This pin can be connected to VCCA to provide power for the Gate Drive. VCCD should be connected to VCCA with the shortest possible trace and decouple with a minimum 1µF capacitor. Alternatively, VCCD could be connected to an external supply (not greater than 5V). |
| PGND1→4 | 36,31,16,21 | Ground connection for the low side gate driver. Should be routed as the return line of the GL signal. Connect at low side FET source. |
| AVDD | 1 | Output of the internal 1.8V LDO. A decoupling capacitor should be placed between AVDD and AGND close to the chip (with short traces). |
| DVDD | 2 | Input for powering the internal digital logic. This pin should be connected to AVDD. |
| DGND | 10 | Digital Ground. Connect this pin to the ground plane at the exposed pad with a separate trace. |
| AGND | 11 | Analog Ground. Connect this pin to the ground plane at the exposed pad with a separate trace |
| GL1-GL4 | 35,30,17,22 | Output pin of the low side gate driver. Connect directly to the respective gate of an external N-channel MOSFET. |



A New Direction in Mixed-Signal

XRP7714EVB-DEMO-X

Four Channel Digital PWM Demo Boards

| Name | Pin Number | Description |
|-------------------------|-------------|--|
| GH1-GH4 | 33,28,19,24 | Output pin of the high side gate driver. Connect directly to the respective gate of an external N-channel MOSFET. |
| LX1-LX4 | 34,29,18,23 | Lower supply rail for the high-side gate driver (GHx). Connect this pin to the switching node at the junction between the two external power MOSFETs and the inductor. These pins are also used to measure voltage drop across bottom MOSFETs in order to provide output current information to the control engine. |
| BST1-BST4 | 32,27,20,25 | High side driver supply pin(s). Connect BST to an external boost diode and a capacitor as shown in the front page diagram. The high side driver is connected between the BST pin and LX pin. |
| GPIO0-GPIO3 | 3,4,5,6 | These pins can be configured as inputs or outputs to implement custom flags, power good signals and enable/disable controls. A GPIO pin can also be programmed as an input clock synchronizing IC to external clock. Refer to the "GPIO Pins" Section and the "External Clock Synchronization" Section for more information. |
| GPIO4_SDA, GPIO5_SCL | 7,8 | I2C serial interface communication pins. These pins can be re-programmed to perform GPIO functions in applications when I2C bus is not used. |
| VOUT1→4 | 12,13,14,15 | Voltage sense. Connect to the output of the corresponding power stage. |
| LDOOUT | 40 | Output of the Standby LDO. It can be configured as a 5V or 3.3V output. A compensation capacitor should be used on this pin [see Application Note]. |
| ENABLE | 9 | If ENABLE is pulled high, the chip powers up (logic reset, registers configuration loaded, etc.). If pulled low for longer than 100us, the XRP7714 is placed into shutdown. |
| AGND | Exposed Pad | Analog Ground. Connect to analog ground (as noted above for pin 11). |

ORDERING INFORMATION

Refer to XRP7714EVB-DEMO-X's datasheet and/or www.exar.com for exact and up to date ordering information.



A New Direction in Mixed-Signal

XRP7714EVB-DEMO-X

Four Channel Digital PWM Demo Boards

USING THE EVALUATION BOARD

INPUT VOLTAGE CONFIGURATION

The XRP7714EVB-DEMO-1 Board has several different input voltage options. The Input voltage components are rated at 35V. The power components have been optimized for a 12V input rail. When running the board at an input voltage other than 12V, use PowerArchitect™ to evaluate the system performance.

Single Wide Range, Input Voltage Rail

Both the XRP7714EVB-DEMO-1 and the XRP7714EVB-DEMO-2P ship from the factory configured for a single wide range input. The Input voltage range is from 5.5V to 25V.

Single 5V Voltage Rail

Installing a zero ohm resistor into position R28 connects VIN to VCCA. This allows operation down to 4.75V, but restricts the maximum input voltage to 5.5V.

Dual Voltage Rail Operation

The XRP7714EVB-DEMO-x boards can be configured to operate from two separate rails.

The following modifications must be made:

- Remove 0 ohm resistors R2 and R13
- Connect power for the XRP7714 between pins VIN and GND
- Connect channel power between pins VIN1 and GND

I²C INTERFACE

The XRP77XX family of controllers employs a standard I2C interface. Pull-ups for the I2C signals are not included on the demo board. If using the demo board with something other than the XRP77xxEVB-XCM, verify that the SDA and SCL lines are pulled up.

Channel Design and Limitations

Channel 1 is designed to provide an output voltage from 3.3V to 5.0V. The default voltage is 3.3V.

Channel 2 is designed to provide an output voltage from 1.8V to 2.5V. The default voltage is 2.5V.

Channel 3 is designed to provide an output voltage from 1.5V to 1.8V. The default voltage is 1.8V.

Channel 4 is designed to provide an output voltage from .9 to 1.2V. The default voltage is 1.0V. The Tantalum output capacitor is has a 2.5V rating. If modifying the channel 3 design, do not exceed four volts unless the C45 is replaced.

ENABLE PIN

The ENABLE pin connects to an RC network This delays turn on of the device. It is pulled up to AVDD with a 100K resistor and to ground through a .01uFd capacitor. It appears on pin 9 of connector CON5. This pin can be used to turn on or turn off the device.

BOARD DIFFERENCES

The XRP7714EVB-DEMO-1 board is 2" x 2" and does not have the facility for a power connector. This board may be available through distribution, but is no longer manufactured.

The XRP7714EVB-DEMO-2 board is 2" x 2.5" and comes from the factory with wired for Single 5V operation (note: some boards were shipped without populating R28. R28 must be populated for single rail 5V operation). The Power Jack has been removed from the board. Supplying more than 5V to the board will damage the XRP7714. This board may be available through distribution, but is no longer manufactured.

The XRP7714EVB-DEMO-2P board is 2" x 2.5" and comes from the factory wired for a single wide range input. The P denotes that a power connector is installed for connection to a power supply of the customers choosing. The center lead of the input connector is positive.

Operating the Evaluation Board

Note: The XRP7714EVB-DEMO-2, is designed to be powered from the USB voltage that is supplied to from the host PC through the XCM board. No additional power connections are

required to demonstrate basic board functionality. If connecting the board to an external power source, do not exceed 5.5V on the chip or it will be damaged.

Make sure that the board is configured for the power supply(s) that you are using. Refer to the Input Voltage Configuration section if you require specific board modifications for your application.

Bring up Procedure

Plug the PowerXR evaluation board on to the XCM as shown below.

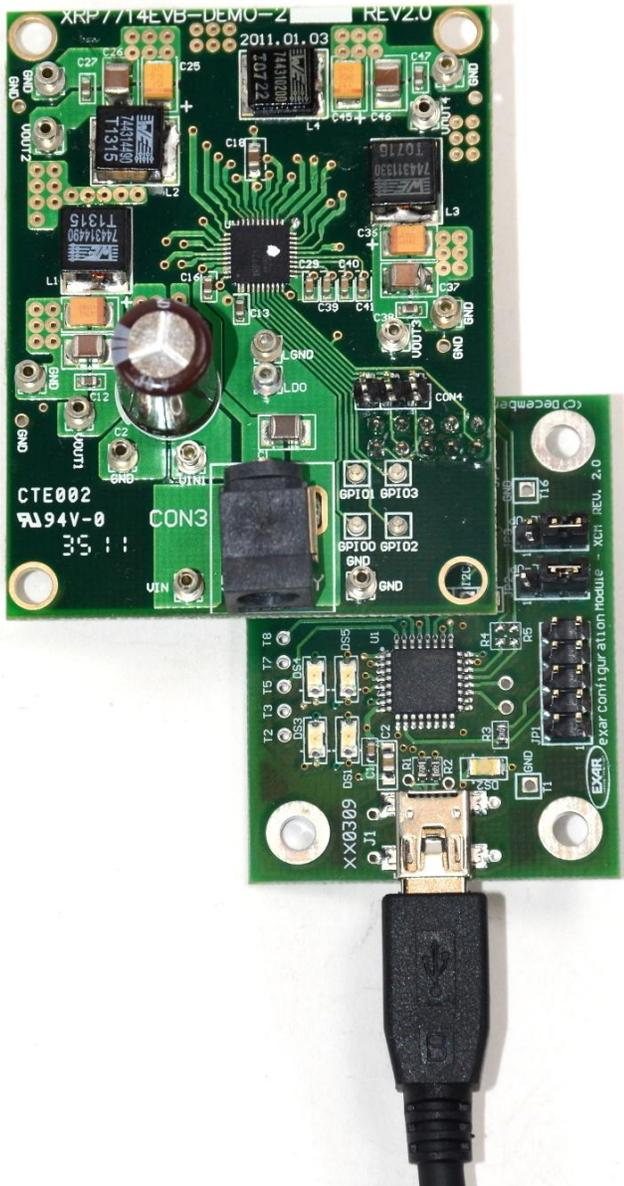

Insert the USB cable into the computer and the XCM board.

Load the PowerArchitect™ software.

Select the XRP7714EVB configuration and select "Create Configuration".

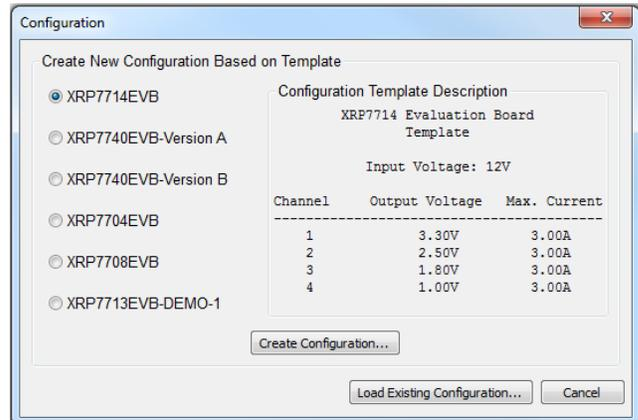

You will be prompted for a filename by a Create New File Dialog box. Navigate to a location to save the configuration, enter a filename and select Save.

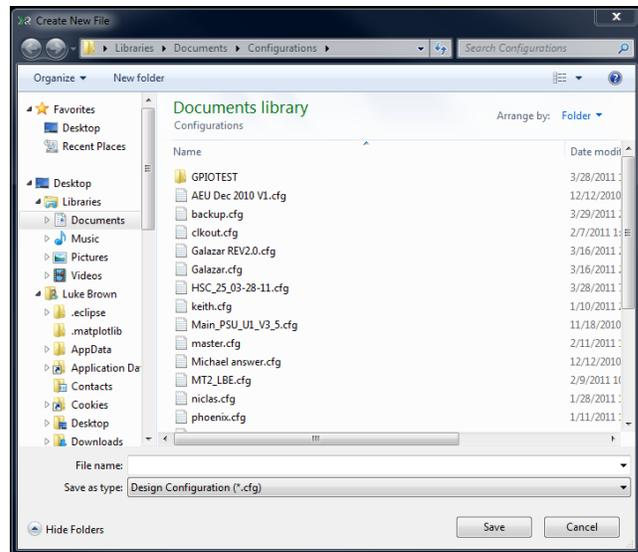

If the XCM board is recognized, there will be an "XCM" tab. If not, "Ctrl-b" should initiate a board search and find it.

On the "DEMO" tab, the lower left should indicate a board connected, but the rest of the page should be grey'd out.

Apply Power to the board: Please refer to the appropriate board connection diagram for your specific evaluation board. If using a single



A New Direction in Mixed-Signal

XRP7714EVB-DEMO-X

Four Channel Digital PWM Demo Boards

supply, Connect the input supply between the VIN pin and the GND pin. If using a dual supply, Connect the chip power between VIN/VINP pin and GND, and connect Power Vin between the VIN1 pin and GND. If using the 5V only option with R28 populated, no power connections are necessary.

Turn on the Power supply. The "DEMO" page should now become live indicating

communication with the XRP7714. Click "Program Chip" and a window should pop up indicating "Success". Now click on the box at the middle right "Enable All".

Refer to the Exar PowerArchitect™ Quick Start Guide for information on how to run the software.

EVALUATION BOARD CONNECTIONS: DEMO-2P

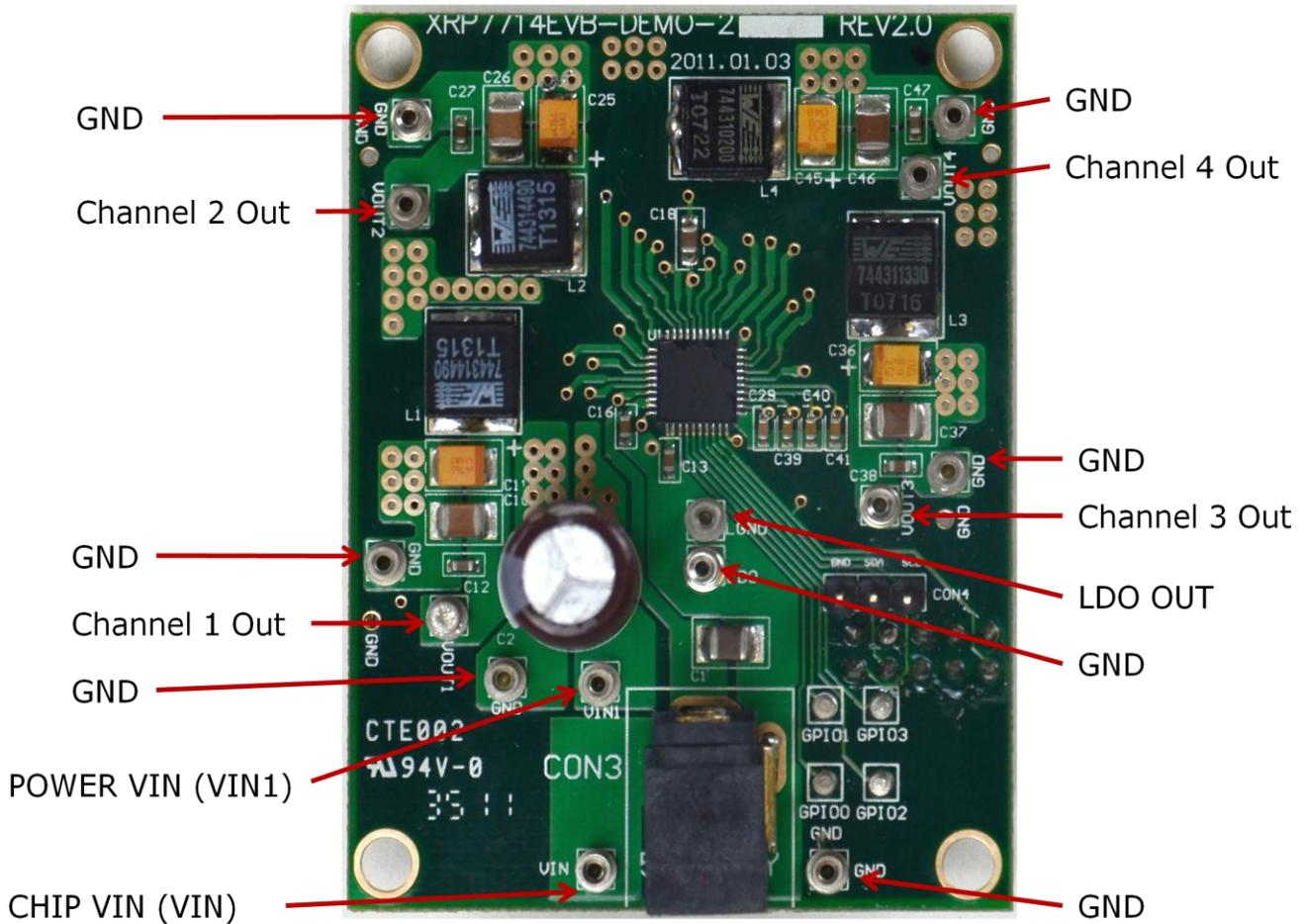

Figure 3: XRP7714EVB-DEMO-2P Board Connections

EVALUATION BOARD CONNECTIONS: DEMO-2

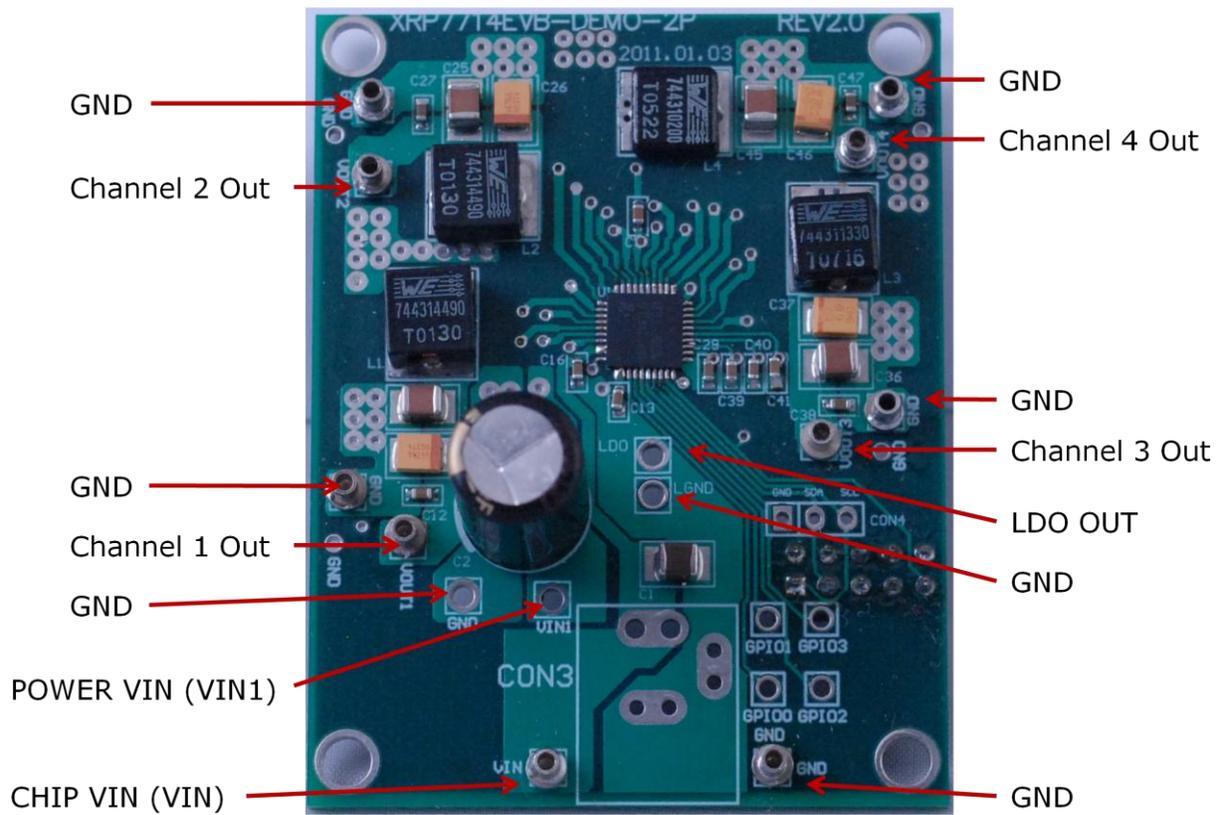

Figure 4: XRP7714EVB-DEMO-2 Board Connections

EVALUATION BOARD CONNECTIONS: DEMO-1

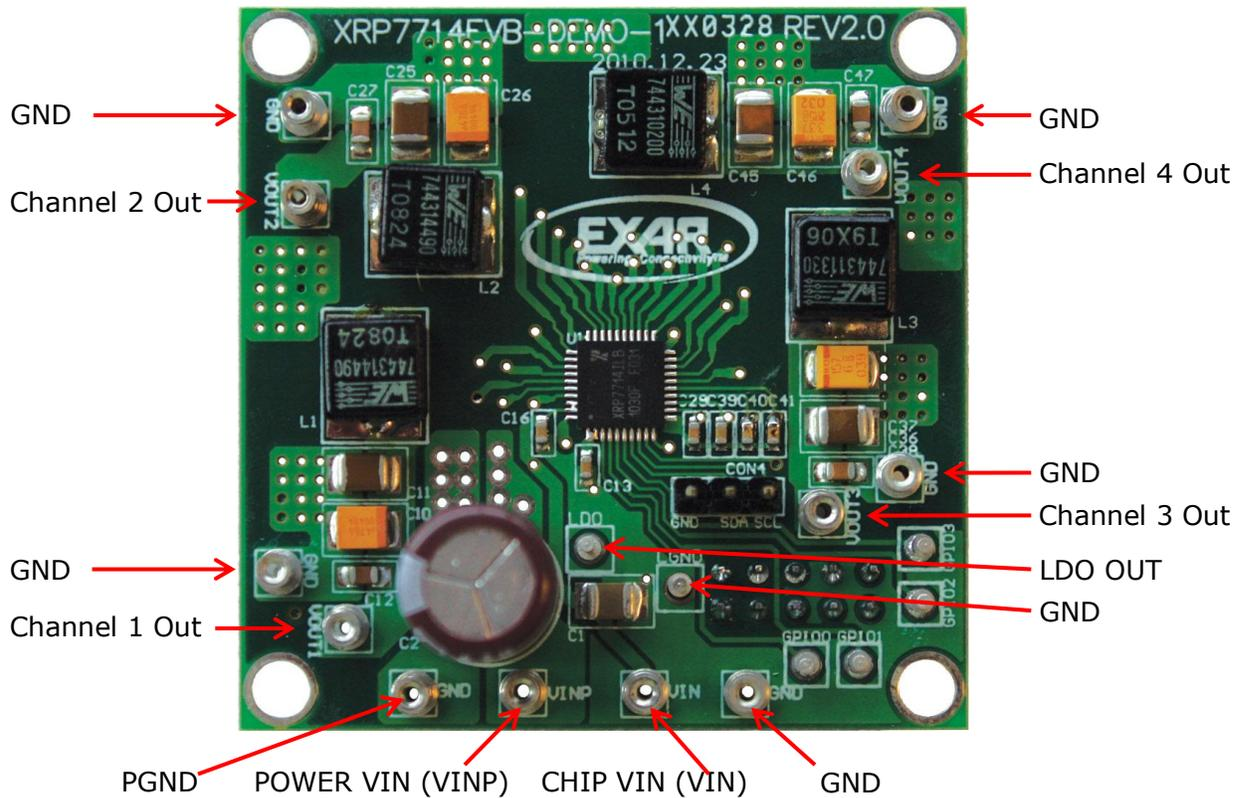

Figure 5: XRP7714EVB-DEMO-1 Board Connections



A New Direction in Mixed-Signal

XRP7714EVB-DEMO-X

Four Channel Digital PWM Demo Boards

BILL OF MATERIAL

| Ref. | Qty | Part Number | Manufacturer | Size | Description |
|--|-----|--------------------|------------------|------------------|--|
| U1 | 1 | XRP7714ILB-F | EXAR CORP | QFN40 | 4 Ch. 25V PWM Step Down Controller QFN40 |
| Q1,Q2,Q3,Q4 | 4 | FDS8984 | FAIRCHILD | 8-SOIC | 30mohm MOSFET N-CH DUAL 30V 6A 8-SOIC |
| Alternate Q1,Q2,Q3,Q4 | 4 | FDS6930B | FAIRCHILD | 8-SOIC | 50mohm MOSFET N-CH DUAL 30V 5.5A 8-SOIC |
| D1,D2,D3,D4 | 4 | SD101AWS | Diodes Inc. | SOD-323 | Diode Schottky, 40V, 400mW, SOD-323 |
| L1,L2 | 2 | 744314490 | WURTH ELEKTRONIK | 7.0x6.9mm | Inductor 4.9uH, 14.5mΩ, 6.5A |
| L3 | 1 | 744311330 | WURTH ELEKTRONIK | 7.0x6.9mm | Inductor 3.3uH, 9.0mΩ, 9.0A |
| L4 | 1 | 744310200 | WURTH ELEKTRONIK | 7.0x6.9mm | Inductor 2.0uH, 5.85mΩ, 11.5A |
| C1,C6,C20,C31,C43 | 5 | GRM32ER7Y106KA12L | MURATA CORP. | 1210 | Cap Cer 10uF, 35V, X7R, 10% 1210 |
| C2 | 1 | EKZE350ELL471MJ20S | United Semi-Con | Radial, Can | Cap Aluminium 470uF, 35V, 20%, 23mOhm |
| C10,C26,C37,C46 | 4 | GRM32ER61C476ME15L | MURATA CORP. | 1210 | CAP CER 47uF, 16V, 20%, X5R, 1210 |
| C12,C13,C16,C27,C38,C47 | 6 | GRM188R71H104KA93D | MURATA CORP. | 603 | Cap Cer 0.1uF, 50V,X7R, 0603 |
| C3,C17,C18 | 3 | GRM21BR71A225KA01L | MURATA CORP. | 805 | Cap Cer 2.2uF, 10V, X7R, 0805 |
| C8,C23,C28,C33,C34 | 5 | GRM188R71H103KA01D | MURATA CORP. | 603 | Cap Cer 0.01uF, 50V,X7R,0603 |
| C9,C24,C29,C35,C39,C40,C41,C44 | 8 | GRM188R71H102KA01D | MURATA CORP. | 603 | Cap Cer 1000pF,50V,X7R,0603 |
| C11,C25 | 2 | TCJB476M010R0070 | AVX CORP. | 1210 | Cap Tant 47uF, 10V, 20%, 1210 |
| C36 | 1 | T520B157M006ATE070 | KEMET | 1411 | Cap Tant 150uF, 6.3V, 20%, 1411 |
| C45 | 1 | T520B337M2R5ATE045 | KEMET | 1411 | Cap Tant 330uF, 2.5V, 20%, 1411 |
| R1,R3,R4,R10,R11,R18,R19,R23,R24 | 9 | CRCW06034R99FKEA | Vishay/Dale | 603 | Res 4.99 Ohm, 1%, 1/10W, 0603 |
| R2,R13 | 2 | CRCW12060000Z0EA | Vishay/Dale | 1206 | Res 0.0 Ohm, 1/4W, 1206 |
| R5,R12,R20,R25 | 4 | CRCW08054R99FKEA | Vishay/Dale | 805 | Res 4.99 Ohm, 1%, 1/8W, 0805 |
| R6 | 1 | CRCW02010000Z0ED | Vishay/Dale | 603 | Res 0.0 Ohm, 1/20W, 0603 |
| R15 | 1 | CRCW0603100KFKEA | Vishay/Dale | 603 | Res 100K Ohm, 1%, 1/0W, 0603 |
| CON3 | 1 | RAPC722X | Switchcraft Inc. | 2.1mmID, 5.5mmOD | Conn PoweJack Mini R/A |
| CON4 | 1 | 61304011121 | WURTH ELEKTRONIK | 2.54mm, 3 PIN | 2.54mm pin header |
| CON5 | 1 | 61301021821 | WURTH ELEKTRONIK | 2.54mm, 10 pins | 2.54mm Dual Socket Header |
| GPO0,GPO1,GPO2,GPO3 | 4 | 1528-2 | KEYSTONE | 0.082 | SINGLE TURRET |
| GND,TIP4,TIP5,TIP6,TIP8,TIP10,TIP11,TIP13,TIP14,VIN,VIN1,VOUT1,VOUT2,VOUT4 | 14 | 1562-2 | KEYSTONE | 0.084 | SINGLE TURRET |

EVALUATION BOARD LAYOUT

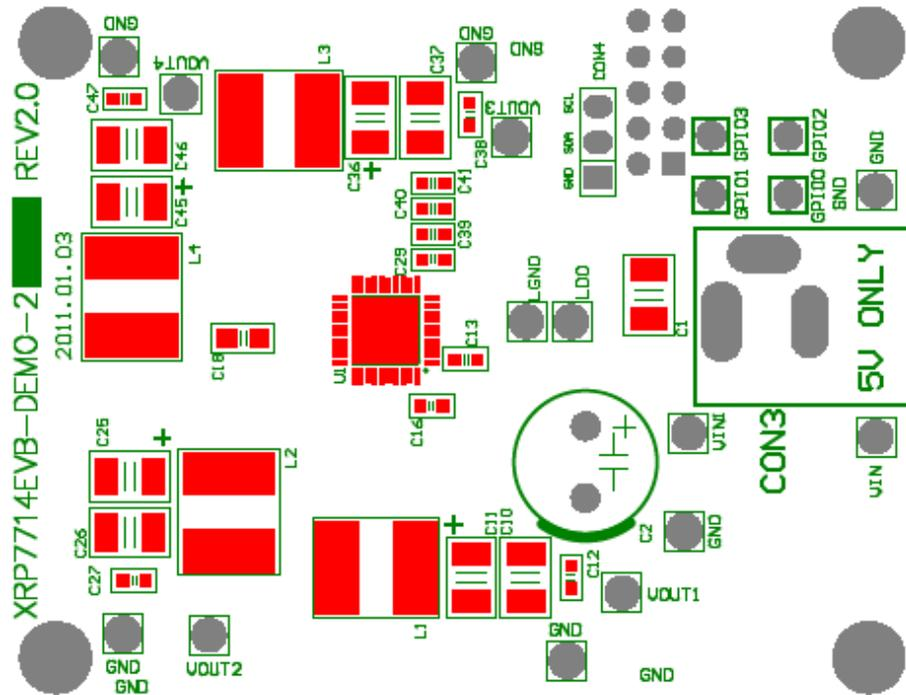

Fig. 3: Component Placement – Top Side

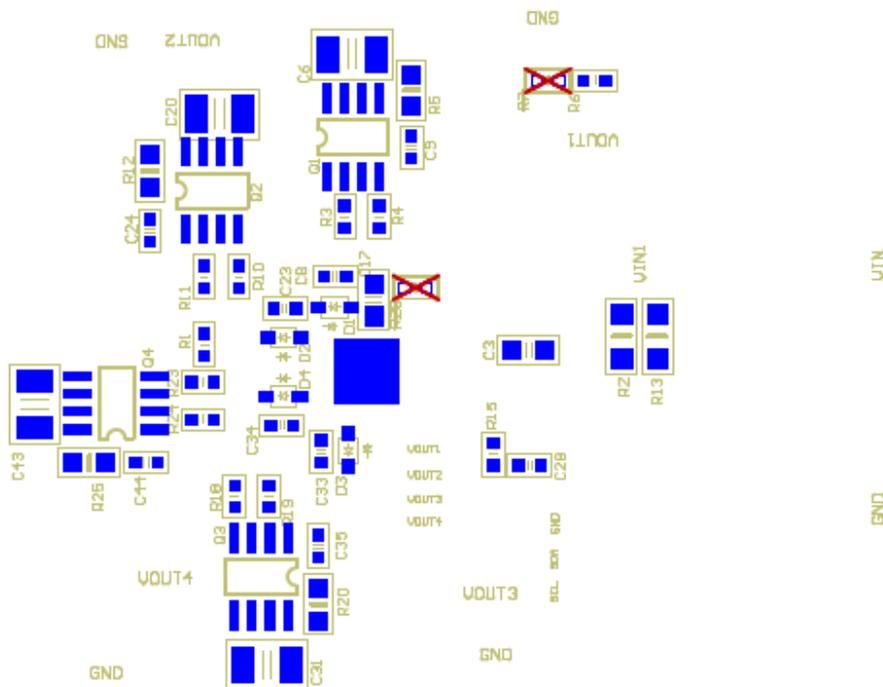

Fig. 4: Component Placement – Bottom Side

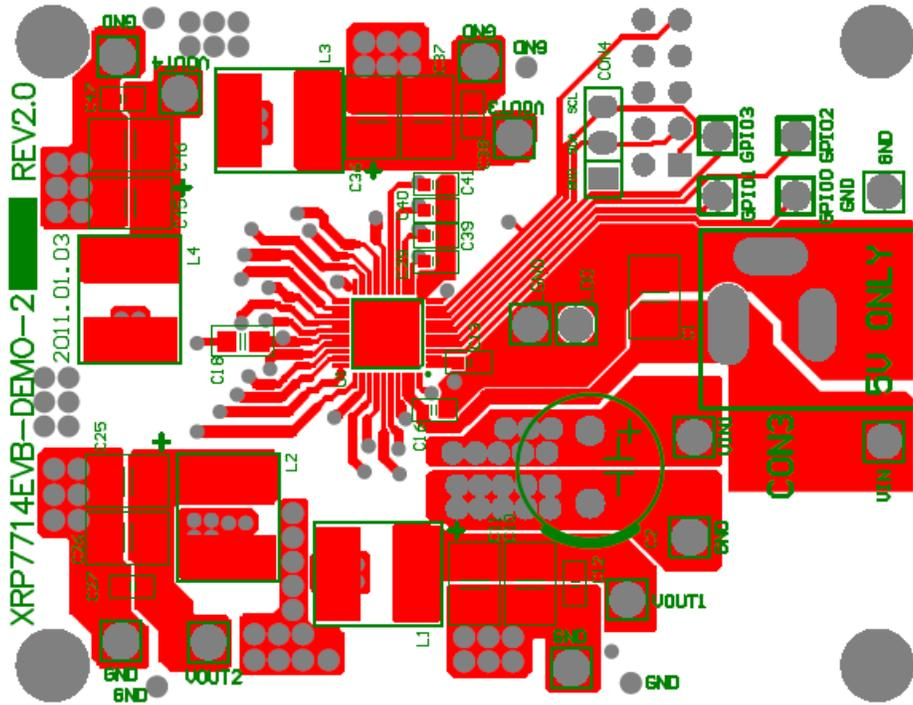

Fig. 5: Layout - Top Side

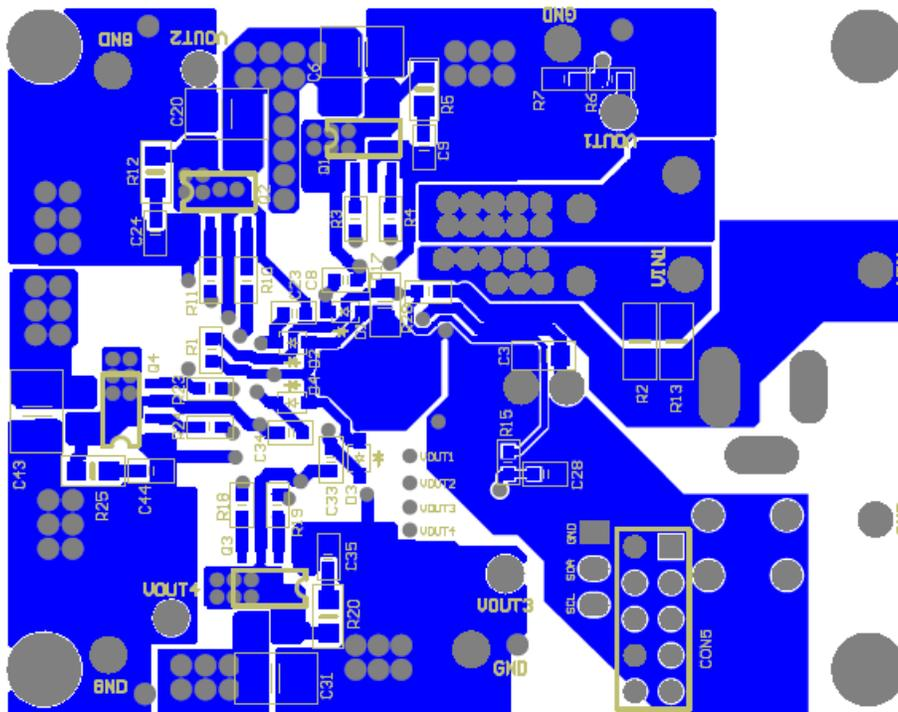

Fig. 6: Layout - Bottom

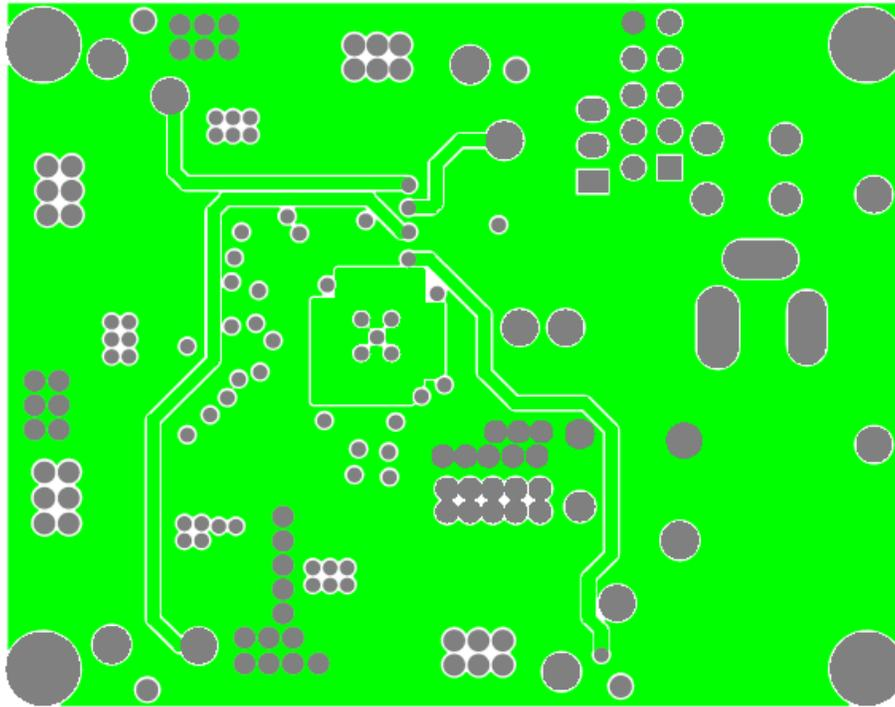

Fig. 7: Layout – Internal Plane

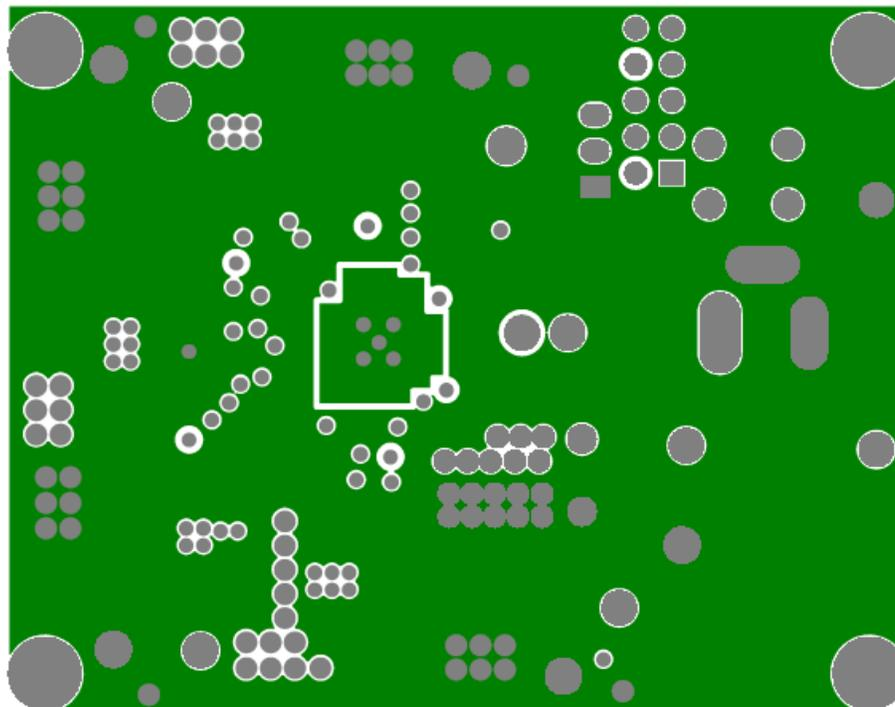

Fig. 8: Layout – Internal Plane

EVALUATION BOARD EFFICIENCY PERFORMANCE

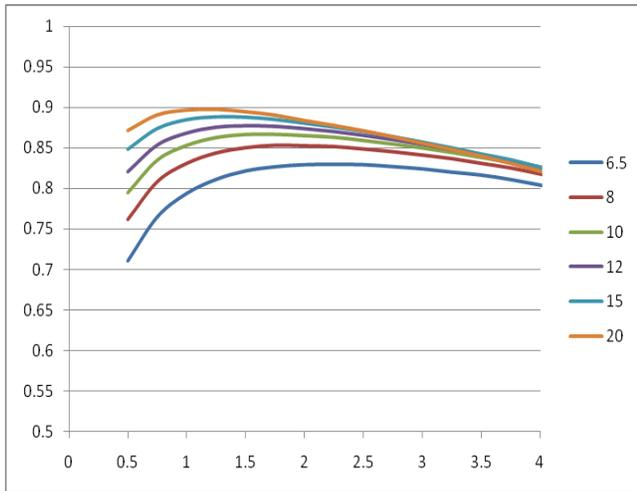

Fig. 9: All Channels Efficiency

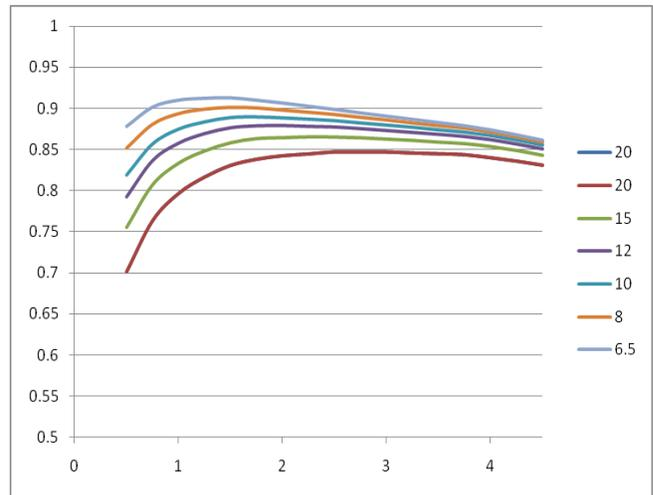

Fig. 10: 3.3V Efficiency

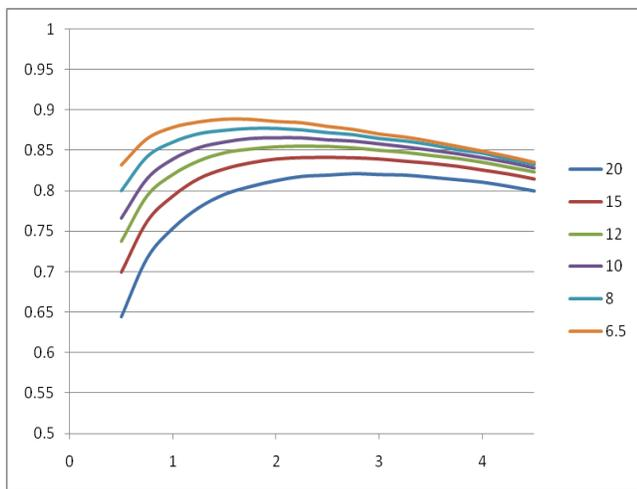

Fig. 11: 2.5V Efficiency

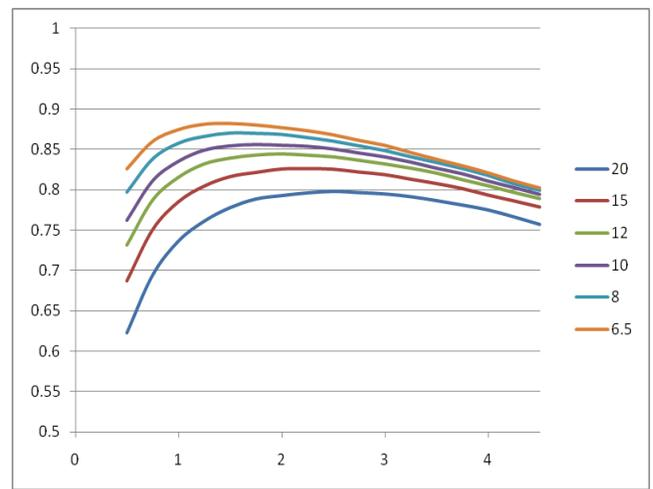

Fig. 12: 1.8V Efficiency

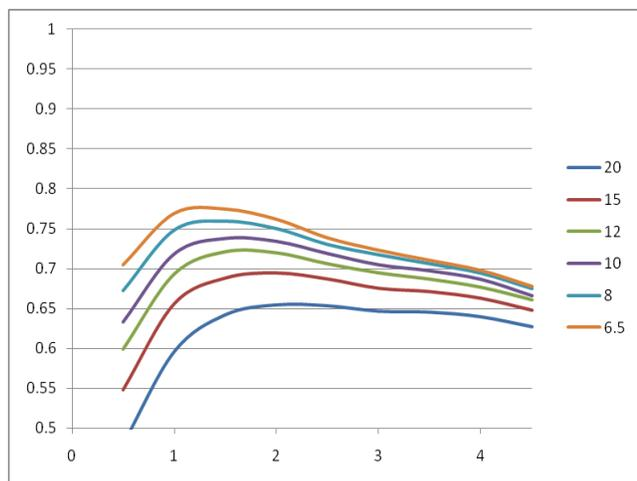

Fig.13: 1V Efficiency

EVALUATION BOARD LINE LOAD REGULATION PERFORMANCE

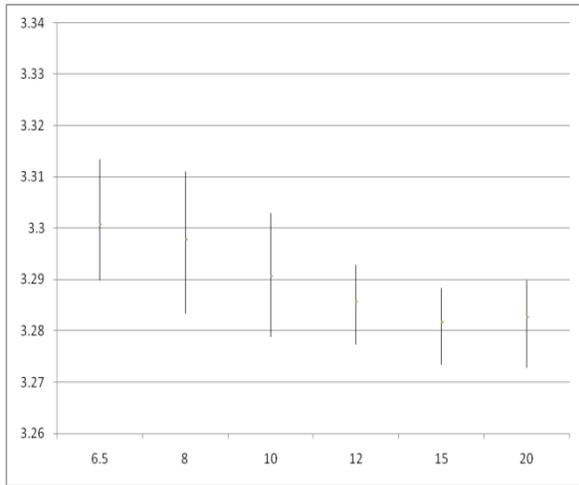

Fig. 14: Line Load Regulation 3.3V

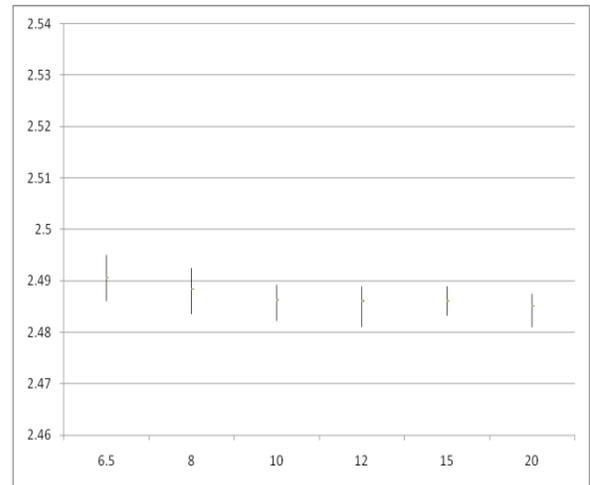

Fig. 15: Line Load Regulation 2.5V

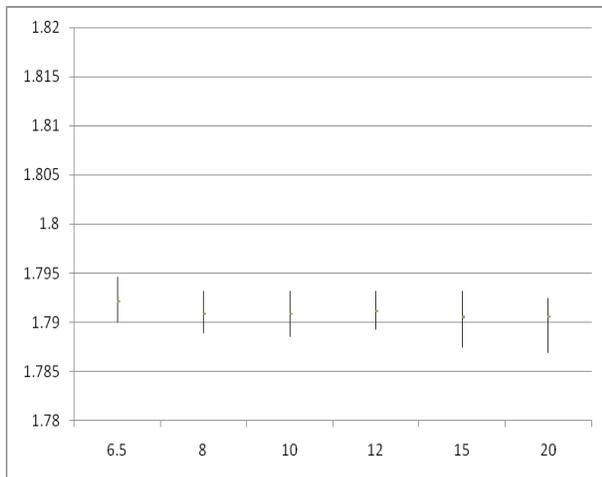

Fig. 16: Line Load Regulation 1.8V

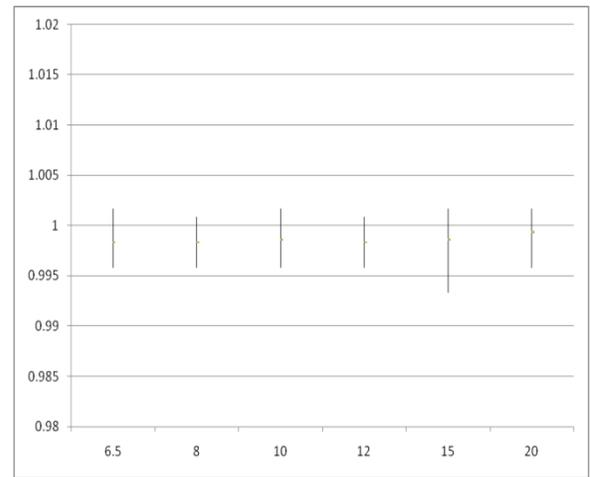

Fig. 17: Line Load Regulation 1.0V



A New Direction in Mixed-Signal

XRP7714EVB-DEMO-X

Four Channel Digital PWM Demo Boards

DOCUMENT REVISION HISTORY

| Revision | Date | Description |
|----------|------------|--|
| 1.0.0 | 04/15/2011 | Initial release of document |
| 1.1.0 | 06/15/2011 | Corrected BOM and schematic (channels 2 and 3 were swapped in schematic). Noted discontinuance of -1 and -2 boards. Added note regarding omitted R28 on some -2 boards. Added picture of proper connection of XCM. |
| 1.1.1 | 10/01/2012 | Added FDS6930B as alternate BOM. A limited number of boards were built with these MOSFETs due to availability of the primary part number. Logo change. |

BOARD REVISION HISTORY

| Board Revision | Date | Description |
|----------------|------------|--|
| REV2.0 | 01/03/2011 | Initial release of evaluation boards 2 and 2P. |
| REV1.0 | 12/23/2010 | Initial release of evaluation board 1. Note: Limited to a production of 150 units. |
| | | |

FOR FURTHER ASSISTANCE

Email:

powertechsupport@exar.com

customersupport@exar.com

Exar Technical Documentation:

<http://www.exar.com/TechDoc/default.aspx?>



A New Direction in Mixed-Signal

EXAR CORPORATION

HEADQUARTERS AND SALES OFFICES

48720 Kato Road

Fremont, CA 94538 - USA

Tel.: +1 (510) 668-7000

Fax: +1 (510) 668-7030

www.exar.com

NOTICE

EXAR Corporation reserves the right to make changes to the products contained in this publication in order to improve design, performance or reliability. EXAR Corporation assumes no responsibility for the use of any circuits described herein, conveys no license under any patent or other right, and makes no representation that the circuits are free of patent infringement. Charts and schedules contained here in are only for illustration purposes and may vary depending upon a user's specific application. While the information in this publication has been carefully checked; no responsibility, however, is assumed for inaccuracies.

EXAR Corporation does not recommend the use of any of its products in life support applications where the failure or malfunction of the product can reasonably be expected to cause failure of the life support system or to significantly affect its safety or effectiveness. Products are not authorized for use in such applications unless EXAR Corporation receives, in writing, assurances to its satisfaction that: (a) the risk of injury or damage has been minimized; (b) the user assumes all such risks; (c) potential liability of EXAR Corporation is adequately protected under the circumstances.

Reproduction, in part or whole, without the prior written consent of EXAR Corporation is prohibited.

Mouser Electronics

Authorized Distributor

Click to View Pricing, Inventory, Delivery & Lifecycle Information:

Exar:

[XRP77XXEVB-XPM](#)