



SF2059B-1

- **Low Insertion Loss**
- **5.0 X 7.0 mm Surface-Mount Case**
- **Differential Input and Output**
- **Complies with Directive 2002/95/EC (RoHS)**



**137.50 MHz
SAW Filter**

Absolute Maximum Ratings

Rating	Value	Units
Maximum Incident Power in Passband	+10	dBm
Max. DC voltage between any 2 terminals	30	VDC
Storage Temperature Range	-40 to +85	°C
Max Soldering Temperature	265°C for 10 s	

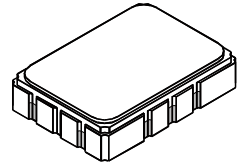

SMP-03

Electrical Characteristics

Characteristic	Sym	Notes	Min	Typ	Max	Units
Nominal Center Frequency	f_c	1		137.50		MHz
Passband Minimum Insertion Loss 1 dB Passband 3 dB Passband Amplitude Ripple from 137.1 to 137.9 MHz 40 dB Bandwidth	IL	1		8.3	9.1	dB
	BW_1	1, 2	0.8	0.86		MHz
	BW_3	1		1.0		
			1, 2		0.85	1.3
				2.2	3.5	MHz
Operating Temperature Range	T_A	1	-40		+85	°C
Differential Input and Output Impedance			L & C Match to 50 ohms			
Case Style		5	SMP-03 7 x 5 mm Nominal Footprint			
Lid Symbolization (YY=year, WW=week, S=shift) See note 4			RFM SF2059B-1 YYWWS##			

Notes:

1. Unless noted otherwise, all specifications apply over the operating temperature range with filter soldered to the specified demonstration board with impedance matching to 50 Ω and measured with 50 Ω network analyzer.
2. Unless noted otherwise, all frequency specifications are referenced to the nominal center frequency, f_c .
3. The design, manufacturing process, and specifications of this filter are subject to change.
4. Tape and Reel Standard Per ANSI / EIA 481.
5. Either Port 1 or Port 2 may be used for either input or output in the design. However, impedances and impedance matching may vary between Port 1 and Port 2, so that the filter must always be installed in one direction per the circuit design.
6. US and international patents may apply.
7. RFM, stylized RFM logo, and RF Monolithics, Inc. are registered trademarks of RF Monolithics, Inc.
8. ©Copyright 1999, RF Monolithics Inc.
9. Electrostatic Sensitive Device. Observe precautions for handling. 

SMP-03 Case

10-Terminal Ceramic Surface-Mount Case
7 x 5 mm Nominal Footprint

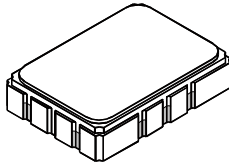

Recommended PCB Footprint

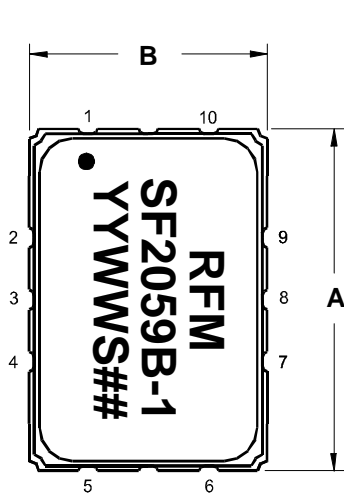
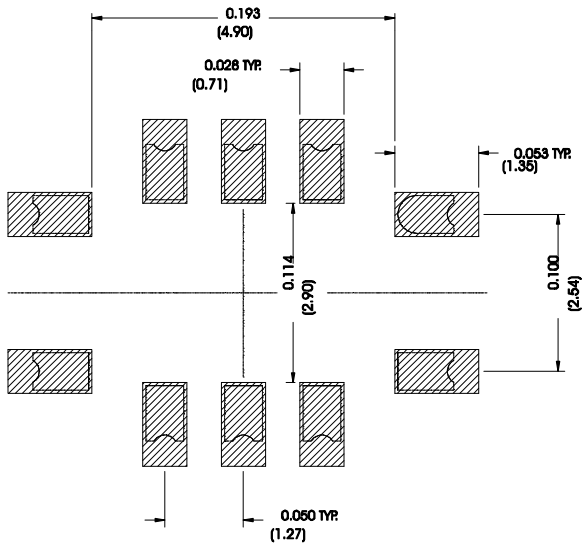

TOP VIEW

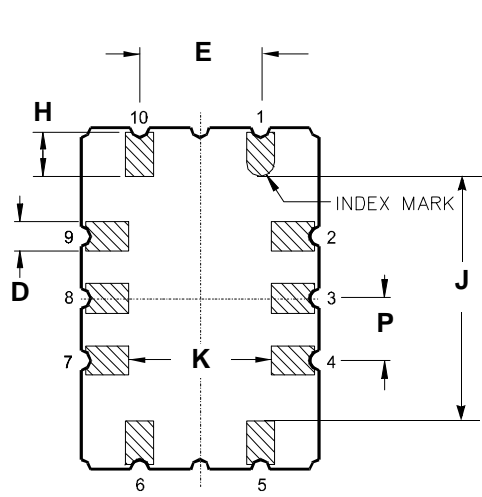
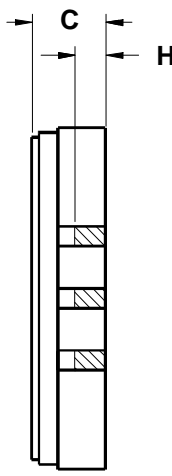

BOTTOM VIEW

Case Dimensions						
Dimension	mm			Inches		
	Min	Nom	Max	Min	Nom	Max
A	6.80	7.00	7.20	0.268	0.276	0.283
B	4.80	5.00	5.20	0.189	0.197	0.205
C	1.50	1.65	2.00	0.059	0.065	0.079
D	.47	0.60	.73	0.019	0.024	0.029
E	2.41	2.54	2.67	0.095	0.100	0.105
H	0.87	1.0	1.13	0.034	0.039	0.044
J	4.87	5.00	5.13	0.192	0.197	0.202
K	2.87	3.00	3.13	0.113	0.118	0.123
P	1.14	1.27	1.40	0.045	0.050	0.055

Materials	
Solder Pad Termination	Au plating 30 - 60 μinches (76.2-152 μm) over 80-200 μinches (203-508 μm) Ni.
Lid	Fe-Ni-Co Alloy Electroless Nickel Plate (8-11% Phosphorus) 100-200 μinches Thick
Body	Al ₂ O ₃ Ceramic
Pb Free	

Electrical Connections		
Connection		Terminals
Port 1	Input or Return	10
	Return or Input	1
Port 2	Output or Return	5
	Return or Output	6
Ground		All others
Single Ended Operation		Return is ground
Differential Operation		Return is hot

Tape and Reel Specifications

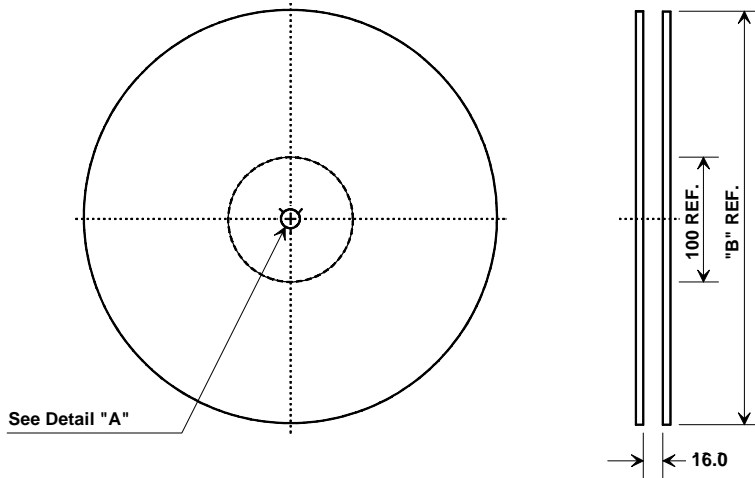

"B "		Quantity Per Reel
Inches	millimeters	
7	178	500
13	330	2000

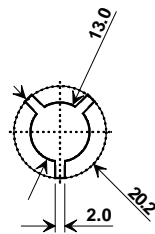

COMPONENT ORIENTATION and DIMENSIONS

Carrier Tape Dimensions	
Ao	5.5 mm
Bo	7.5 mm
Ko	2.0 mm
Pitch	8.0 mm
W	16.0 mm

