

Typical Applications

The HMC571LC5 is ideal for:

- Point-to-Point and Point-to-Multi-Point Radio
- Military Radar, EW & ELINT
- Satellite Communications

Features

- 9 dB Conversion Gain
- Image Rejection: 18 dB
- 2 LO to RF Isolation: 35 dB
- Noise Figure: 3.0 dB
- Input IP3: +2 dBm
- RoHS Compliant 5x5 mm SMT Package

Functional Diagram

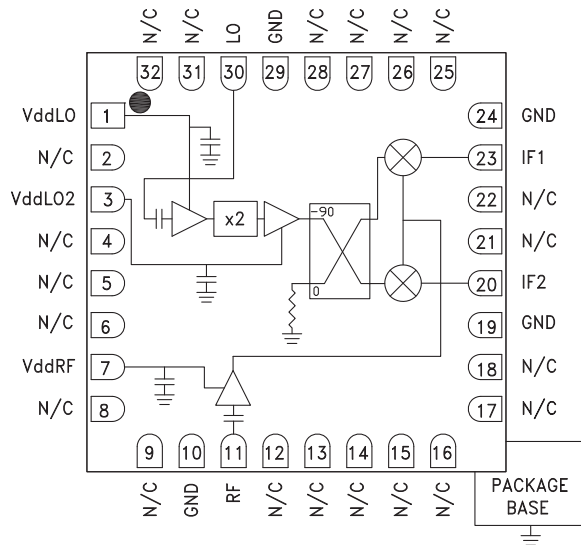

General Description

The HMC571LC5 is a compact GaAs MMIC I/Q downconverter in a leadless RoHS compliant SMT package. This device provides a small signal conversion gain of 9 dB with a noise figure of 3.0 dB and 18 dB of image rejection across the frequency band. The HMC571LC5 utilizes an LNA followed by an image reject mixer which is driven by an active x2 multiplier. The image reject mixer eliminates the need for a filter following the LNA, and removes thermal noise at the image frequency. I and Q mixer outputs are provided and an external 90° hybrid is needed to select the required sideband. The HMC571LC5 is a much smaller alternative to hybrid style image reject mixer downconverter assemblies, and it eliminates the need for wire bonding by allowing the use of surface mount manufacturing techniques.

Electrical Specifications, $T_A = +25^\circ C$, $IF = 100 MHz$, $LO = +4 dBm$, $Vdd = 3.5 Vdc^*$

| Parameter | Min. | Typ. | Max. | Min. | Typ. | Max. | Units |
|--------------------------|-------------|------|------|----------|------|------|-------|
| Frequency Range, RF | 21.2 - 23.7 | | | 21 - 25 | | | GHz |
| Frequency Range, LO | 9 - 14 | | | 9 - 14 | | | GHz |
| Frequency Range, IF | DC - 3.5 | | | DC - 3.5 | | | GHz |
| Conversion Gain (As IRM) | 9 | 11 | | 8 | 11 | | dB |
| Noise Figure | | 3 | | | 3 | | dB |
| Image Rejection | 18 | 22 | | 15 | 23 | | dB |
| 1 dB Compression (Input) | -7 | -5 | | -9 | -6 | | dBm |
| 2 LO to RF Isolation | 50 | 60 | | 55 | 40 | | dB |
| 2 LO to IF Isolation | 40 | 45 | | 38 | 45 | | dB |
| IP3 (Input) | +4 | +6 | | -1 | +5 | | dBm |
| Amplitude Balance | | 0.8 | | | 0.3 | | dB |
| Phase Balance | | 5 | | | 4 | | Deg |
| Total Supply Current | | 125 | 150 | | 125 | 150 | mA |

*Data taken as IRM with external IF Hybrid

For price, delivery, and to place orders, please contact Hittite Microwave Corporation:
20 Alpha Road, Chelmsford, MA 01824 Phone: 978-250-3343 Fax: 978-250-3373
Order On-line at www.hittite.com

Data Taken As IRM With External IF Hybrid

Conversion Gain vs. Temperature

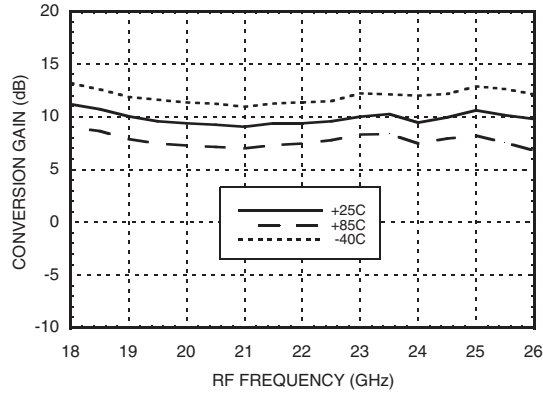
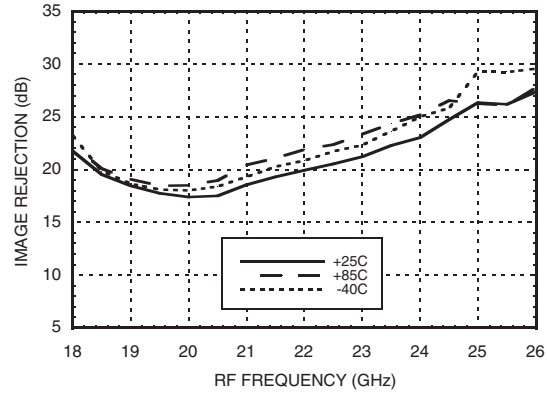
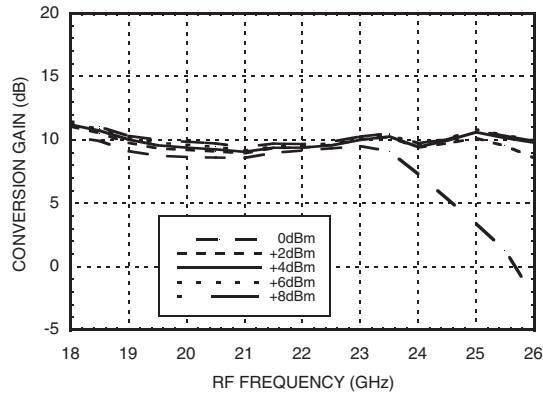

Image Rejection vs. Temperature



Conversion Gain vs. LO Drive



Return Loss

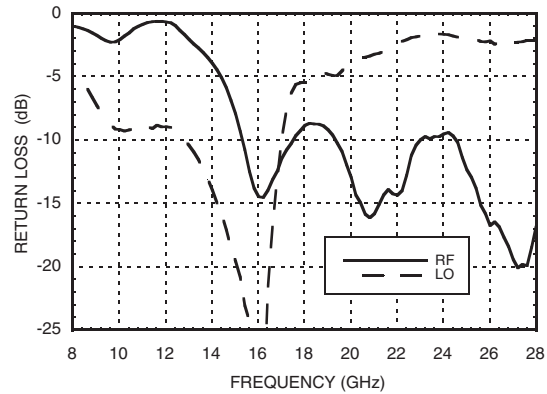

Input P1dB vs. Temperature

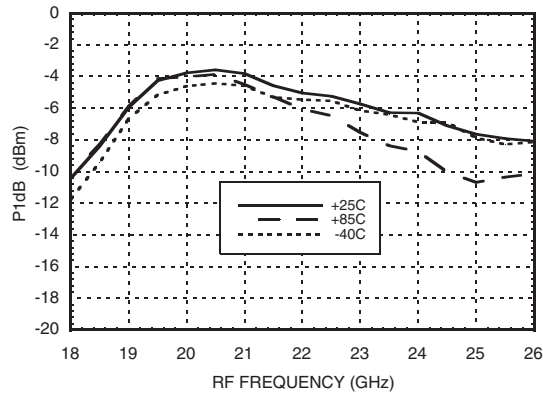

Input IP3 vs. LO Drive

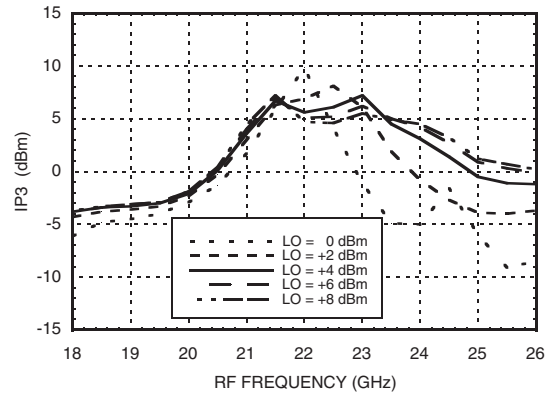



Quadrature Channel Data Taken Without IF Hybrid

Isolations

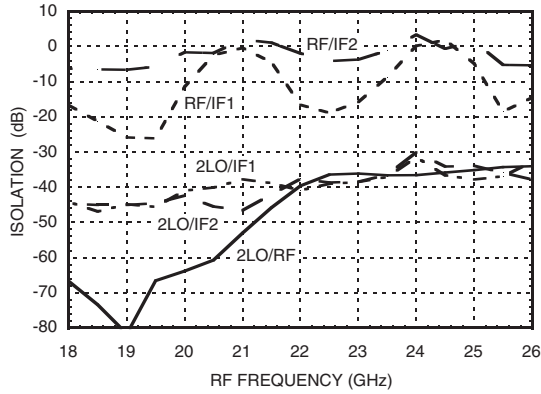

IF Bandwidth*

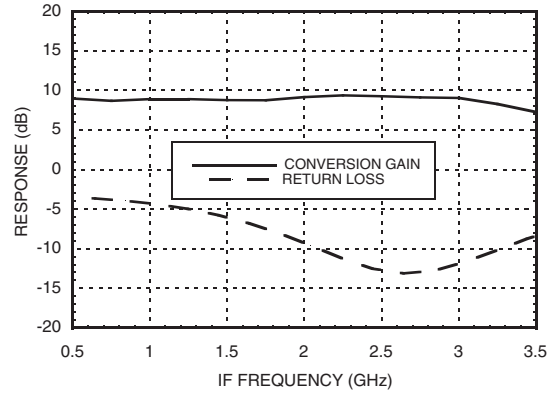

Amplitude Balance vs. LO Drive

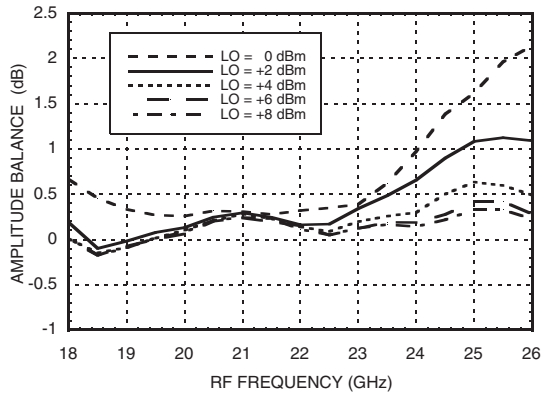

Phase Balance vs. LO Drive

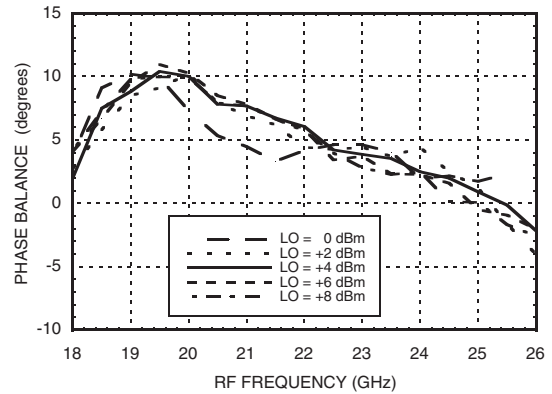

Noise Figure vs. LO Drive, LO Frequency = 10.3 GHz

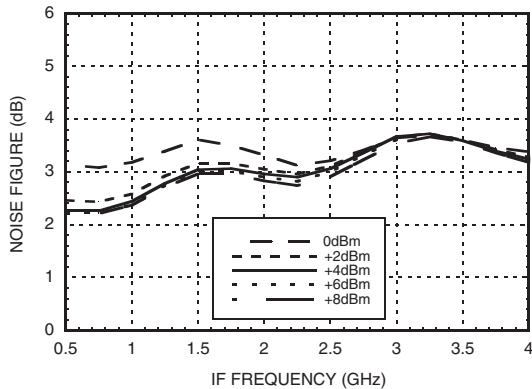

Noise Figure vs. LO Drive, IF Frequency = 100 MHz

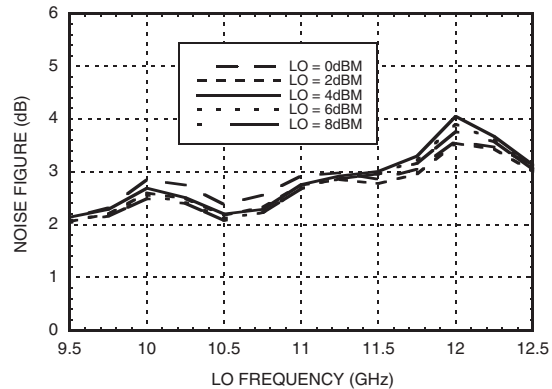

* Conversion gain data taken with external IF hybrid, LO frequency fixed at 10.3 GHz and RF varied

MxN Spurious Outputs

| mRF | nLO | | | | |
|-----|-----|----|----|----|----|
| | 0 | 1 | 2 | 3 | 4 |
| 0 | xx | 31 | 19 | 25 | 38 |
| 1 | 20 | 32 | 0 | 31 | 48 |
| 2 | xx | xx | 72 | 62 | 43 |
| 3 | xx | xx | xx | xx | 81 |
| 4 | xx | xx | xx | xx | xx |

RF = 18 GHz @ -20 dBm
 LO = 8.5 GHz @ +4 dBm
 Data taken without IF hybrid
 All values in dBc below IF power level (1RF -2LO = 1 GHz)

Absolute Maximum Ratings

| | |
|---|----------------|
| RF | +2 dBm |
| LO Drive | + 13 dBm |
| Vdd | 5.5V |
| Channel Temperature | 175°C |
| Continuous P _{diss} (T=85°C) (derate 9.56 mW/°C above 85°C) | 860 mW |
| Thermal Resistance (R _{TH}) (channel to package bottom) | 104.6 °C/W |
| Storage Temperature | -65 to +150 °C |
| Operating Temperature | -55 to +85 °C |
| ESD Sensitivity (HBM) | Class 1B |



ELECTROSTATIC SENSITIVE DEVICE
OBSERVE HANDLING PRECAUTIONS

Outline Drawing

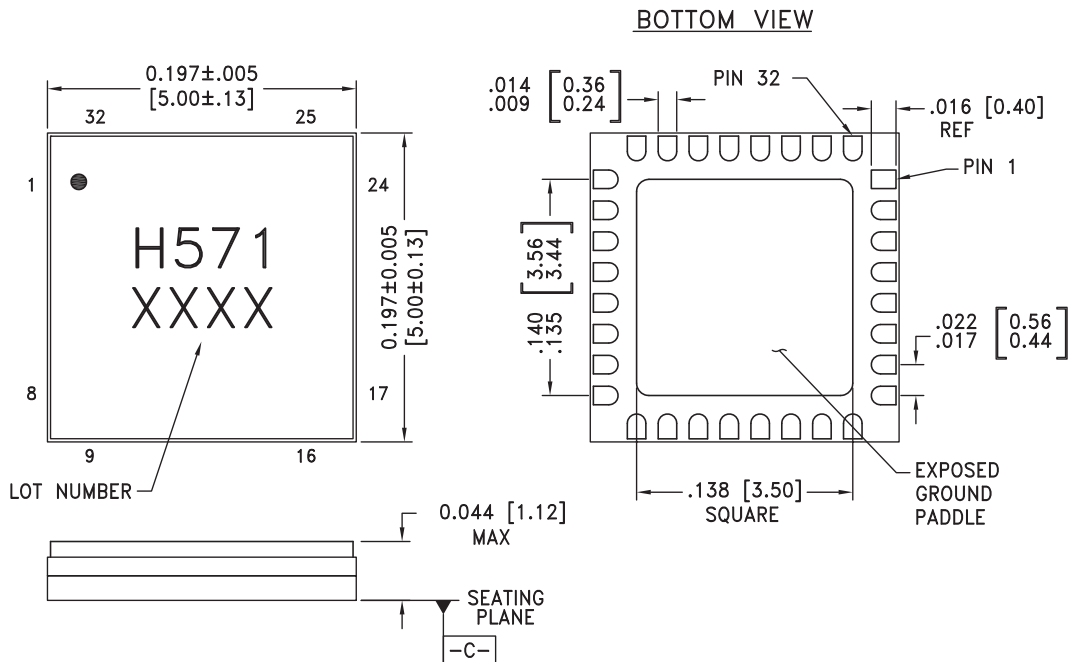

NOTES:

1. PACKAGE BODY MATERIAL: ALUMINA
2. LEAD AND GROUND PADDLE PLATING: 30 - 80 MICROINCHES GOLD OVER 50 MICROINCHES MINIMUM NICKLE
3. DIMENSIONS ARE IN INCHES [MILLIMETERS]
4. LEAD SPACING TOLERANCE IS NON-CUMULATIVE
5. PACKAGE WARP SHALL NOT EXCEED 0.05mm DATUM
6. ALL GROUND LEADS AND GROUND PADDLE MUST BE SOLDERED TO PCB RF GROUND

Pin Descriptions

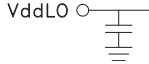
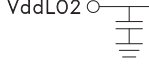
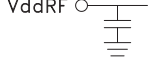
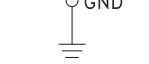
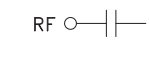
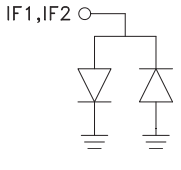
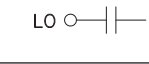
| Pin Number | Function | Description | Interface Schematic |
|--|----------|--|---|
| 1 | VddLO | Power supply for first stage of LO amplifier. |  |
| 2, 4 - 6, 8, 9, 12 - 18, 21, 22, 25 - 28, 31, 32 | N/C | No connection required. These pins may be connected to RF/DC ground without affecting performance. | |
| 3 | VddLO2 | Power supply for second stage of LO amplifier. |  |
| 7 | VddRF | Power supply for RF LNA. |  |
| 10, 19, 24, 29 | GND | These pins and ground paddle must be connected to RF/DC ground. |  |
| 11 | RF | This pin is AC coupled and matched to 50 Ohms. |  |
| 20 | IF2 | This pin is DC coupled for applications not requiring operation to DC. This port should be DC blocked externally using a series capacitor whose value has been chosen to pass the necessary frequency range. For operation to DC, this pin must not sink / source more than 3 mA of current or part non-function and possible failure will result. |  |
| 23 | IF1 | | |
| 30 | LO | This pin is AC coupled and matched to 50 Ohms. |  |

Typical Application

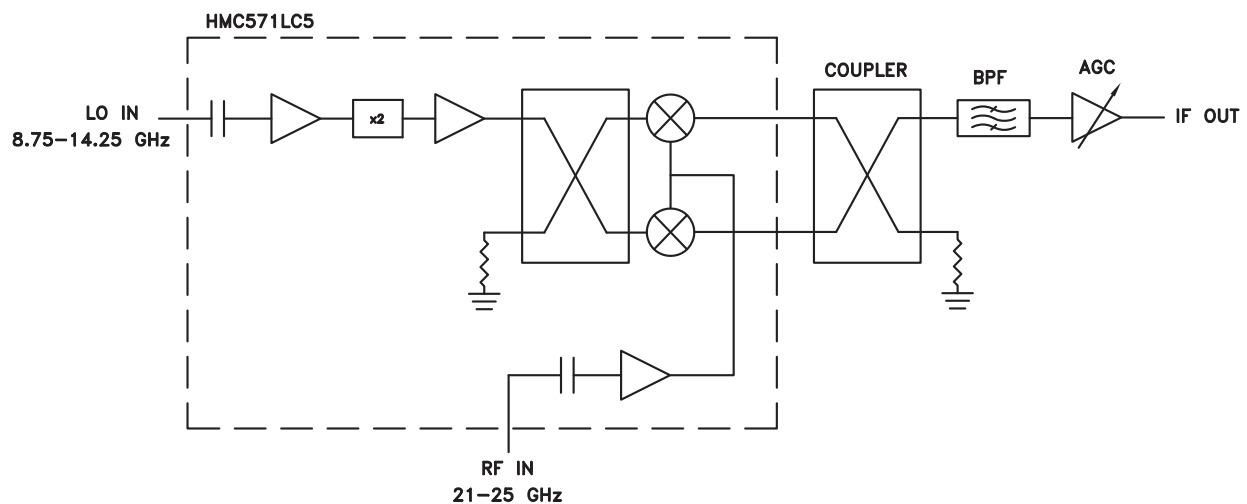

Evaluation PCB

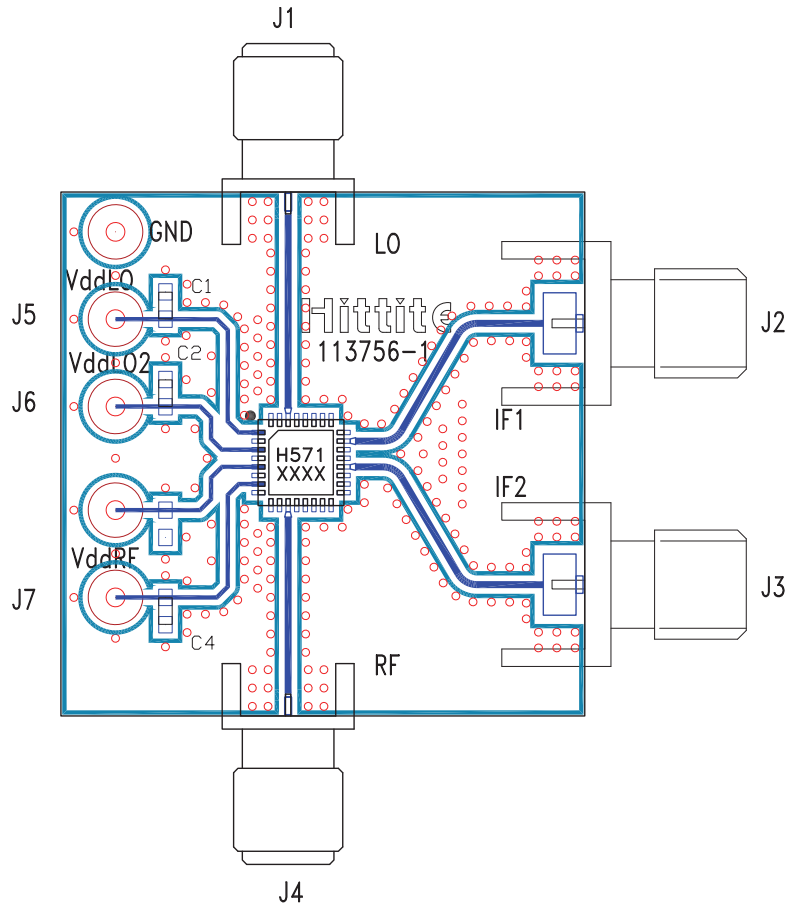

List of Materials for Evaluation PCB 113758 [1]

| Item | Description |
|---------|----------------------------------|
| C1 - C4 | Capacitor 0603, 0.01 μ F |
| J1, J4 | PCB Mount SMA RF Connector, SRI |
| J2, J3 | PCB Mount SMA Connector, Johnson |
| J5 - J7 | DC Pin |
| U1 | HMC571LC5 |
| PCB [2] | 113756 Evaluation Board |

[1] Reference this number when ordering complete evaluation PCB

[2] Circuit Board Material: Rogers 4350

The circuit board used in the final application should use RF circuit design techniques. Signal lines should have 50 ohm impedance while the package ground leads and exposed paddle should be connected directly to the ground plane similar to that shown. A sufficient number of via holes should be used to connect the top and bottom ground planes. The evaluation circuit board shown is available from Hittite upon request.