

# Slotted Optical Switch

OPB825, OPB825A, OPB825B, OPB825R



## Features:

- Non-contact switching
- Fast switching speed
- 0.160" (4.06 mm) wide slot
- 0.300" (7.62 mm) lead spacing
- OPB825R—Optimized for ticket dispensers

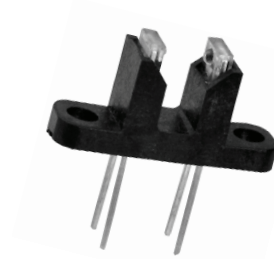

## Description:

Each OPB825, OPB825A and OPB825B have an infrared LED, while the OPB825R has a Red LED. All devices have a NPN silicon phototransistor mounted in a low-cost black plastic housing on opposite sides of a 0.160" (4.064 mm) wide slot. OPB825 and OPB825R have no mounting tabs and is intended for direct insertion into PCBoards or dual-in-line sockets. OPB825A has one mounting tab on the phototransistor side, while OPB825B has mounting tabs on both sides (two tabs). Phototransistor switching takes place whenever an opaque object passes through the slot.

## Applications:

- Non-contact interruptive object sensing
- Assembly line automation
- Machine automation
- Equipment security
- Machine safety
- Ticket Sensing

Ordering Information	
Part Number	Description
OPB825	Slotted Switch (no tabs) IR-LED
OPB825A	Slotted Switch (one tab) IR-LED
OPB825B	Slotted Switch (two tabs) IR-LED
OPB825R	Slotted Switch (no tabs) Red-LED

Pin #	Description	Pin #	Description
1	Anode	3	Collector
2	Cathode	4	Emitter

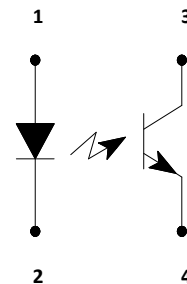

RoHS

### General Note

TT Electronics reserves the right to make changes in product specification without notice or liability. All information is subject to TT Electronics' own data and is considered accurate at time of going to print.

TT Electronics | OPTEK Technology  
1645 Wallace Drive, Carrollton, TX 75006 | Ph: +1 972 323 2200  
www.ttelectronics.com | sensors@ttelectronics.com

# Slotted Optical Switch

OPB825, OPB825A, OPB825B, OPB825R



## Electrical Specifications

**Absolute Maximum Ratings** ( $T_A=25^\circ\text{C}$  unless otherwise noted)

Storage & Operating Temperature Range	-40°C to +85°C
Lead Soldering Temperature [1/16 inch (1.6mm) from the case for 5 sec. with soldering iron] <sup>(1)</sup>	260°C

### Input Diode

	OPB825—A—B	OPB825R
Forward DC Current	50 mA	40 mA
Peak Forward Current (1 μs pulse width, 300 pps)	3 A	-
Reverse DC Voltage	2 V	2 V
Power Dissipation <sup>(2)</sup>	100 mW	100 mW

### Output Phototransistor

	OPB825—A—B	OPB825R
Collector-Emitter Voltage	30 V	24 V
Emitter-Collector Voltage	5 V	0.4 V
Collector DC Current	30 mA	30 mA
Power Dissipation <sup>(2)</sup>	100 mW	100 mW

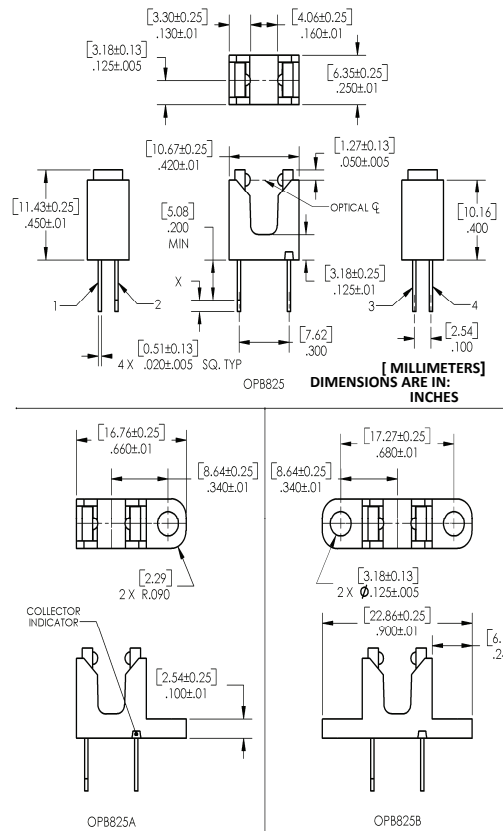

### General Note

TT Electronics reserves the right to make changes in product specification without notice or liability. All information is subject to TT Electronics' own data and is considered accurate at time of going to print.

TT Electronics | OPTEK Technology  
1645 Wallace Drive, Carrollton, TX 75006 | Ph: +1 972 323 2200  
www.ttelectronics.com | sensors@ttelectronics.com

# Slotted Optical Switch

OPB825, OPB825A, OPB825B, OPB825R



## OPB825, OPB825A, OPB825B

Electrical Characteristics ( $T_A = 25^\circ\text{C}$  unless otherwise noted)

SYMBOL	PARAMETER	MIN	TYP	MAX	UNITS	TEST CONDITIONS
--------	-----------	-----	-----	-----	-------	-----------------

**Input Diode** (See OP240 for additional information)

$V_F$	Forward Voltage	-	-	1.6	V	$I_F = 20\text{ mA}$
$I_R$	Reverse Current	-	-	100	$\mu\text{A}$	$V_R = 2\text{ V}$

**Output Phototransistor** (See OP550 for additional information)

$V_{(BR)CEO}$	Collector-Emitter Breakdown Voltage	30	-	-	V	$I_C = 1\text{ mA}$
$V_{(BR)ECO}$	Emitter-Collector Breakdown Voltage	5	-	-	V	$I_E = 100\ \mu\text{A}$
$I_{CEO}$	Collector Dark Current	-	-	100	nA	$V_{CE} = 10\text{ V}, I_F = 0, E_E = 0$

**Combined**

$V_{CE(SAT)}$	Collector-Emitter Saturation	-	-	0.4	V	$I_C = 250\ \mu\text{A}, I_F = 20\text{ mA}$
$I_{C(ON)}$	On-State Collector Current	1.0	-	-	mA	$I_F = 20\text{ mA}, V_{CE} = 10\text{ V}$

## OPB825R

Electrical Characteristics ( $T_A = 25^\circ\text{C}$  unless otherwise noted)

SYMBOL	PARAMETER	MIN	TYP	MAX	UNITS	TEST CONDITIONS
--------	-----------	-----	-----	-----	-------	-----------------

**Input Diode** (See OVLAS6CB8 for additional information)

$V_F$	Forward Voltage	-	2.3	2.6	V	$I_F = 20\text{ mA}$
$I_R$	Reverse Current	-	-	100	$\mu\text{A}$	$V_R = 5\text{ V}$

**Output Phototransistor** (See OP750 for additional information)

$V_{(BR)CEO}$	Collector-Emitter Breakdown Voltage	24	-	-	V	$I_E = 100\ \mu\text{A}, E_E = 0$
$V_{(BR)ECO}$	Emitter-Collector Breakdown Voltage	0.4	-	-	V	$I_E = 100\ \mu\text{A}, E_E = 0$
$I_{CEO}$	Collector Dark Current	-	-	100	nA	$V_{CE} = 10\text{ V}, I_F = 0, E_E = 0$

**Combined**

$I_{C(OFF)}$	OFF-State Collector Current	-	-	0.5	mA	$I_F = 0.80\text{ mA}, V_{CE} = 5.0\text{ V}$
$I_{C(ON)}$	On-State Collector Current	2.5	-	16.0	mA	$I_F = 8.00\text{ mA}, V_{CE} = 0.5\text{ V}$

Notes:

- (1) RMA flux is recommended. Duration can be extended to 10 seconds maximum when flow soldering.
- (2) Derate linearly 1.67 mW/ $^\circ\text{C}$  above  $25^\circ\text{C}$ .
- (3) All parameters tested using pulse techniques.
- (4) Methanol or isopropanol are recommended as cleaning agents. Plastic housing is soluble in chlorinated hydrocarbons and ketones.
- (5) Simulates optical path blocked with thick paper

General Note

TT Electronics reserves the right to make changes in product specification without notice or liability. All information is subject to TT Electronics' own data and is considered accurate at time of going to print.

TT Electronics | OPTEK Technology  
1645 Wallace Drive, Carrollton, TX 75006 | Ph: +1 972 323 2200  
www.ttelectronics.com | sensors@ttelectronics.com

# Slotted Optical Switch

OPB825, OPB825A, OPB825B, OPB825R



## Performance

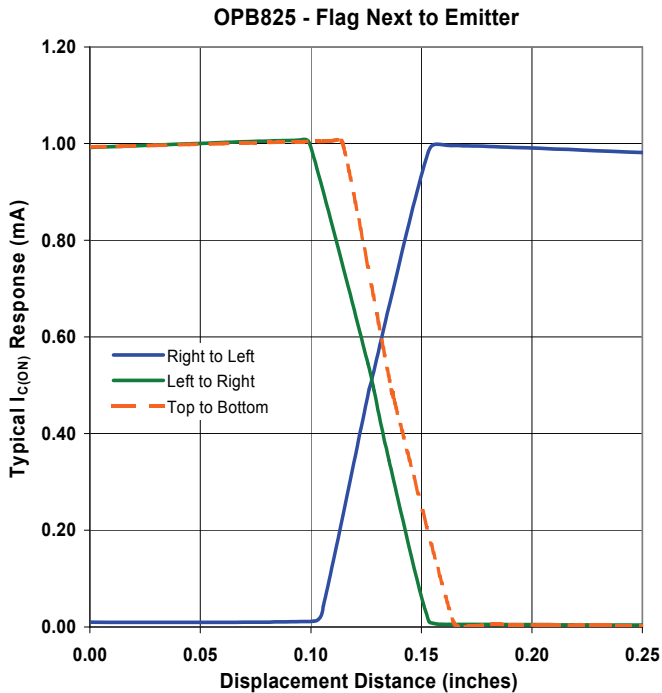
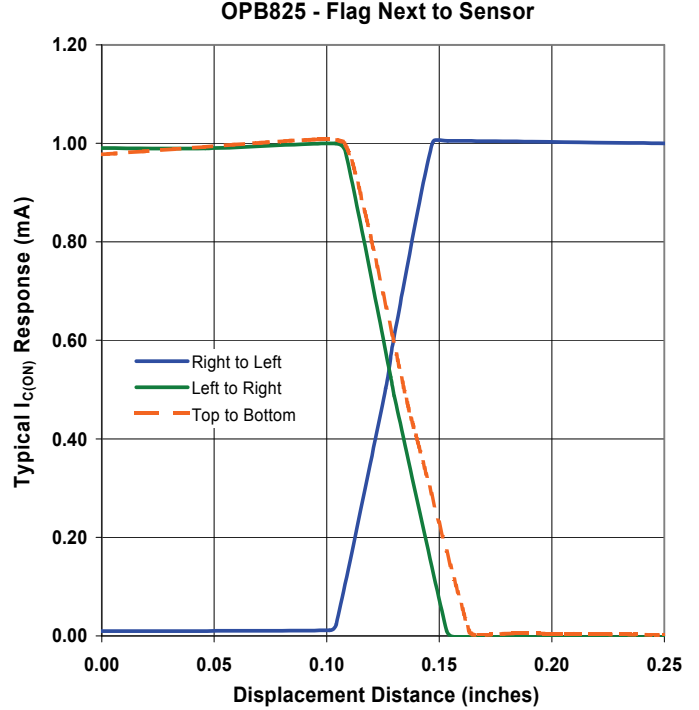
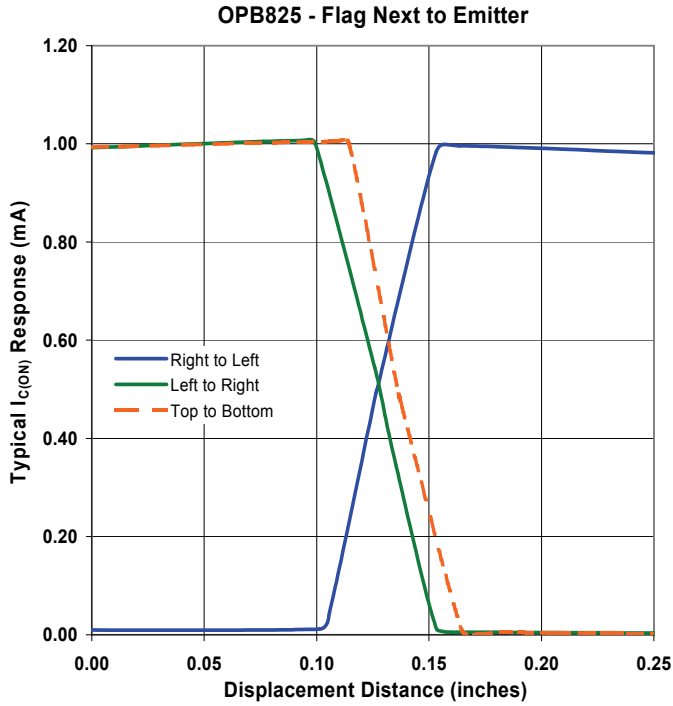

### Test Schematic

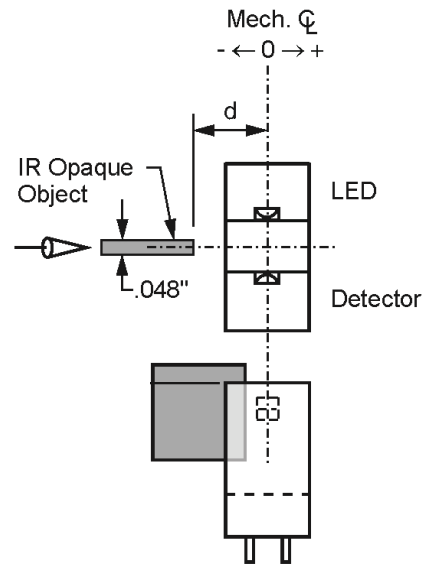

#### General Note

TT Electronics reserves the right to make changes in product specification without notice or liability. All information is subject to TT Electronics' own data and is considered accurate at time of going to print.

TT Electronics | OPTEK Technology  
1645 Wallace Drive, Carrollton, TX 75006 | Ph: +1 972 323 2200  
www.ttelectronics.com | sensors@ttelectronics.com