



MAX5258 Evaluation Kit

General Description

The MAX5258 evaluation kit (EV kit) provides a proven design to evaluate the MAX5258 low-power, 8-bit octal, digital-to-analog converter (DAC). The EV kit also includes Windows® 2000/XP- and Windows Vista®-compatible software that provides a simple graphical user interface (GUI) for exercising the features of the MAX5258.

The MAX5258 EV kit PCB comes with a MAX5258EEE+ installed. This EV kit can also be used to evaluate the MAX5259EEE+ low-power 8-bit octal DAC (2.7V to 3.6V). Contact the factory for free samples of the MAX5259EEE+.

Features

- ◆ Windows 2000/XP- and Windows Vista (32-Bit)-Compatible Software
- ◆ Supports Standard SPI™ Interface
- ◆ USB-PC Connection (Cable Included)
- ◆ USB Powered
- ◆ 16-Pin DAC Output Signal Header
- ◆ Proven PCB Layout
- ◆ Lead-Free and RoHS Compliant
- ◆ Fully Assembled and Tested

Ordering Information

PART	TYPE
MAX5258EVKIT+	EV Kit

+Denotes lead-free and RoHS compliant.

Component List

DESIGNATION	QTY	DESCRIPTION
C1, C3–C10, C17, C25, C27, C28, C29, C31, C32, C34, C35, C36, C37	20	0.1µF ±10%, 16V X7R ceramic capacitors (0603) TDK C1608X7R1C104K
C2, C13, C15, C26, C33	5	10µF ±20%, 6.3V X5R ceramic capacitors (0805) TDK C2012X5R0J106M
C11, C12	2	10pF ±5%, 50V C0G ceramic capacitors (0603) TDK C1608C0G1H100J
C14, C16	2	1µF ±20%, 6.3V X5R ceramic capacitors (0603) TDK C1608X5R0J105K TDK C1608X5R0J105M
C18, C19	2	22pF ±5%, 50V C0G ceramic capacitors (0603) TDK C1608C0G1H220J
C20	1	3300pF ±10%, 50V X7R ceramic capacitor (0603) TDK C1608X7R1H332K
C30	1	4.7µF ±20%, 16V X7R ceramic capacitor (1206) TDK C3216X7R1C475M
D1	1	Green LED (0603)
FB1	1	0Ω ±5% resistor (0603)

DESIGNATION	QTY	DESCRIPTION
H1	0	Not installed, 10-pin JTAG header
H2	1	Dual-row (2 x 8) 16-pin header
H3	1	Dual-row (2 x 5) 10-pin header
JUA–JUE	0	Not installed
JU1–JU5	5	3-pin headers
JU6, JU7	2	4-pin headers
P1	1	USB type-B right-angle female receptacle
R1	1	0Ω ±5% resistor (0603)
R2	1	220Ω ±5% resistor (0603)
R3	1	10kΩ ±5% resistor (0603)
R4	1	2.2kΩ ±5% resistor (0603)
R5	1	1.5kΩ ±5% resistor (0603)
R6, R7	2	27Ω ±5% resistors (0603)
R8–R15	8	100kΩ ±5% resistors (0603)
R16	0	Not installed, resistor (0402)
U1	1	Octal low-power DAC (16 QSOP) Maxim MAX5258EEE+
U2	1	Microcontroller (68 QFN-EP*) Maxim MAXQ2000-RAX+
U3	1	93C46 type 3-wire EEPROM (8 SO) 16-bit architecture

*EP = Exposed pad.

SPI is a trademark of Motorola, Inc.

Windows and Windows Vista are registered trademarks of Microsoft Corp.



Maxim Integrated Products 1

For pricing, delivery, and ordering information, please contact Maxim Direct at 1-888-629-4642, or visit Maxim's website at www.maxim-ic.com.

Evaluates: MAX5258/MAX5259

MAX5258 Evaluation Kit

Component List (continued)

DESIGNATION	QTY	DESCRIPTION
U4	1	UART-to-USB converter (32 TQFP)
U5	1	3.3V regulator (5 SC70) Maxim MAX8511EXK33+T (Top Mark: AEI)
U6	1	2.5V regulator (5 SC70) Maxim MAX8511EXK25+T (Top Mark: ADV)
U7	1	+4.096V voltage reference (8 SO) Maxim MAX6126AASA41+
U8, U9, U10	3	Dual 1.8V to 5V level translators (8 SSOP) (Top Mark: CT2_)
Y1	1	16MHz crystal (HCM49) Hong Kong X'tals SSM1600000E18FAF
Y2	1	6MHz crystal (HCM49) Hong Kong X'tals SSL6000000E18FAF
—	7	Shunts
—	1	USB high-speed A-to-B cable, 6ft
—	1	PCB: MAX5258 Evaluation Kit+

*EP = Exposed pad.

Component Suppliers

SUPPLIER	PHONE	WEBSITE
Hong Kong X'tals Ltd.	852-35112388	www.hongkongcrystal.com
TDK Corp.	847-803-6100	www.component.tdk.com

Note: Indicate that you are using the MAX5258 or MAX5259 when contacting these component suppliers.

MAX5258 EV Kit Files

FILE	DESCRIPTION
INSTALL.EXE	Installs the EV kit files on your computer
MAX5258.EXE	Application program
FTD2XX.INF	USB device driver file
UNINST.INI	Uninstalls the EV kit software
USB_Driver_Help.PDF	USB driver installation help file

Quick Start

Required Equipment

Before beginning, the following equipment is needed:

- MAX5258 EV kit (USB cable included)
- A user-supplied Windows 2000/XP- or Windows Vista-compatible PC with a spare USB port
- Two digital voltmeters (DVMs)
- USB powered. Use optional external power supply for enhanced performance.

Note: In the following sections, software-related items are identified by bolding. Text in **bold** refers to items directly from the EV kit software. Text in **bold and underlined** refers to items from the Windows operating system.

Procedure

The MAX5258 EV kit is fully assembled and tested. Follow the steps below to verify board operation:

- 1) Visit www.maxim-ic.com/evkitsoftware to download the latest version of the EV kit software, 5258Rxx.ZIP. Save the EV kit software to a temporary folder and uncompress the ZIP file.
- 2) Install the EV kit software on your computer by running the INSTALL.EXE program inside the temporary folder. The program files are copied and icons are created in the Windows **Start | Programs** menu.
- 3) Verify that all jumpers (JU1–JU7) are in their default positions, as shown in Table 1.
- 4) Connect the USB cable from the PC to the EV kit board. A **New Hardware Found** window pops up when installing the USB driver for the first time. If you do not see a window that is similar to the one described above after 30 seconds, remove the USB cable from the board and reconnect it. Administrator privileges are required to install the USB device driver on Windows.
- 5) Follow the directions of the **Add New Hardware Wizard** to install the USB device driver. Choose the **Search for the best driver for your device** option. Specify the location of the device driver to be **C:\Program Files\MAX5258** (default installation directory) using the **Browse** button. During device driver installation, Windows may show a warning message indicating that the device driver Maxim uses does not contain a digital signature. This is not an error condition and it is safe to proceed with installation. Refer to the USB_Driver_Help.PDF document included with the software for additional information.

MAX5258 Evaluation Kit

- 6) Start the MAX5258 EV kit software by opening its icon in the **Start | Programs** menu. When the **Part Selection** window appears, click on the **MAX5258** radio button and then press the **Next** button. The EV kit software main window appears, as shown in Figure 1.
- 7) To measure the OUTA voltage, connect the first DVM between H2-1 (OUTA) and H2-2 (GND).
- 8) To measure the OUTB voltage, connect the second DVM between H2-3 (OUTB) and H2-4 (GND).
- 9) Verify that the voltage on both DVMs is approximately 0V.
- 10) Enter **0x3F** into the **D7 - D0 (Shift Register Data Bits)** edit box.
- 11) Press the **Load All DACs** button.
- 12) Verify that the voltage shown on both DVMs is approximately 1V.

Detailed Description of Software

The main window of the evaluation software (shown in Figure 1) displays the voltages and codes for all DAC input and output registers. In addition, the main window has two tabs. The **Load DACs** tab sheet controls all of the DAC loading features of the MAX5258. The

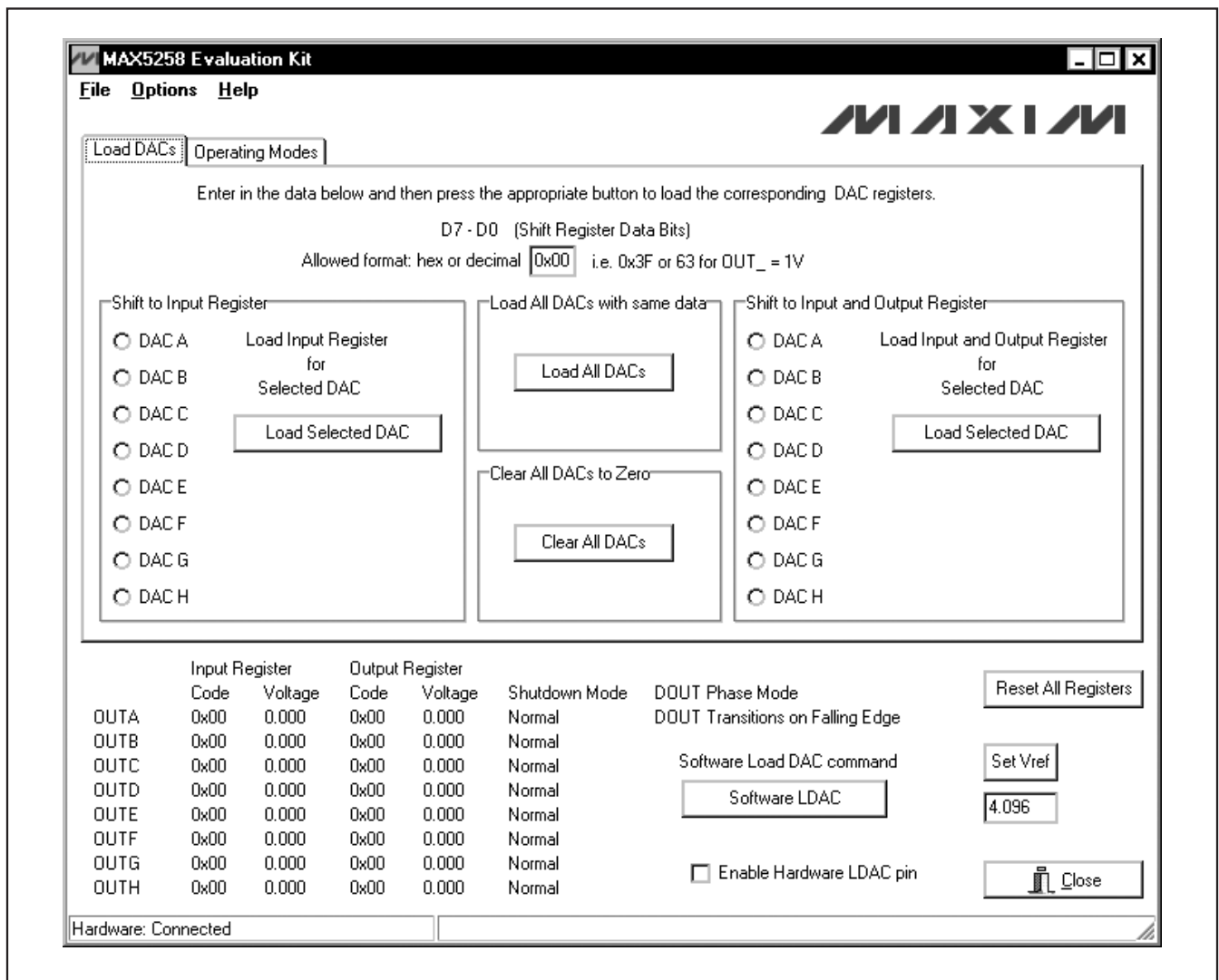

Figure 1. MAX5258 EV Kit Software Main Window (Load DACs Tab)

MAX5258 Evaluation Kit

Operating Modes tab sheet (shown in Figure 2) controls all of the DAC modes of the MAX5258. The **Load Setting(s)** buttons must be pressed to write the corresponding mode settings to the DAC(s).

Software Reset

Press the **Reset All Registers** button to reset the MAX5258's registers and GUI to the power-on-reset (POR) state. This can be done at any time and is highly recommended after using the **Advanced User Interface** window (Figure 3).

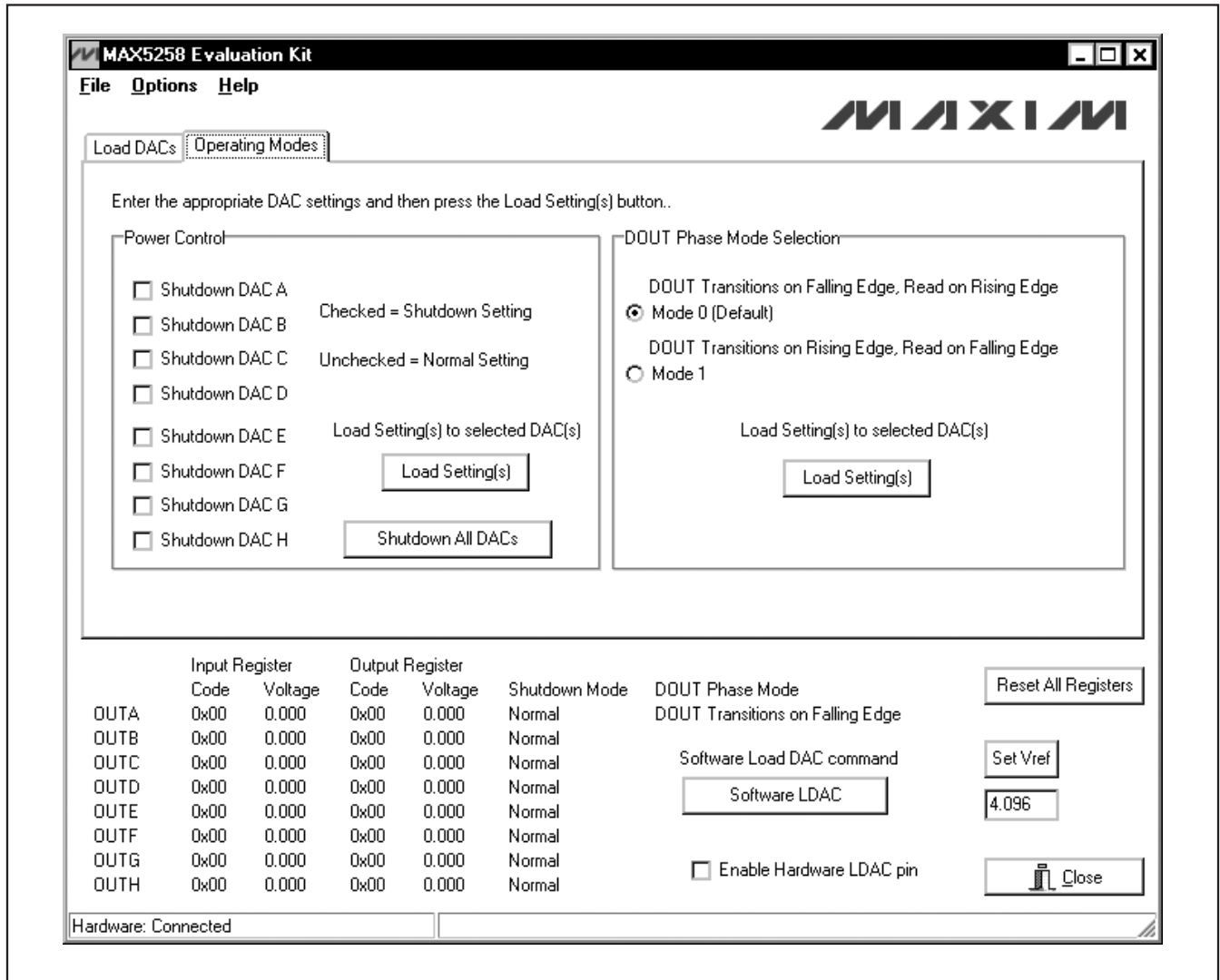

Figure 2. MAX5258 EV Kit Software Main Window (Operating Modes Tab)

MAX5258 Evaluation Kit

Evaluates: MAX5258/MAX5259

Advanced User Interface

A manual serial interface can be established by advanced users by selecting **Options | Interface (Advanced Users)** from the menu bar.

For SPI, click on the **3-wire interface** tab (shown in Figure 3). Enter data into the **Data bytes to be written:** edit box and press the **Send Now** button.

Detailed Description of Hardware

The MAX5258 EV kit provides a proven layout for the MAX5258. An on-board analog output signal header (H2), an on-board digital input/output signal header (H3), and jumpers to disconnect the on-board micro-controller are all included on the EV kit.

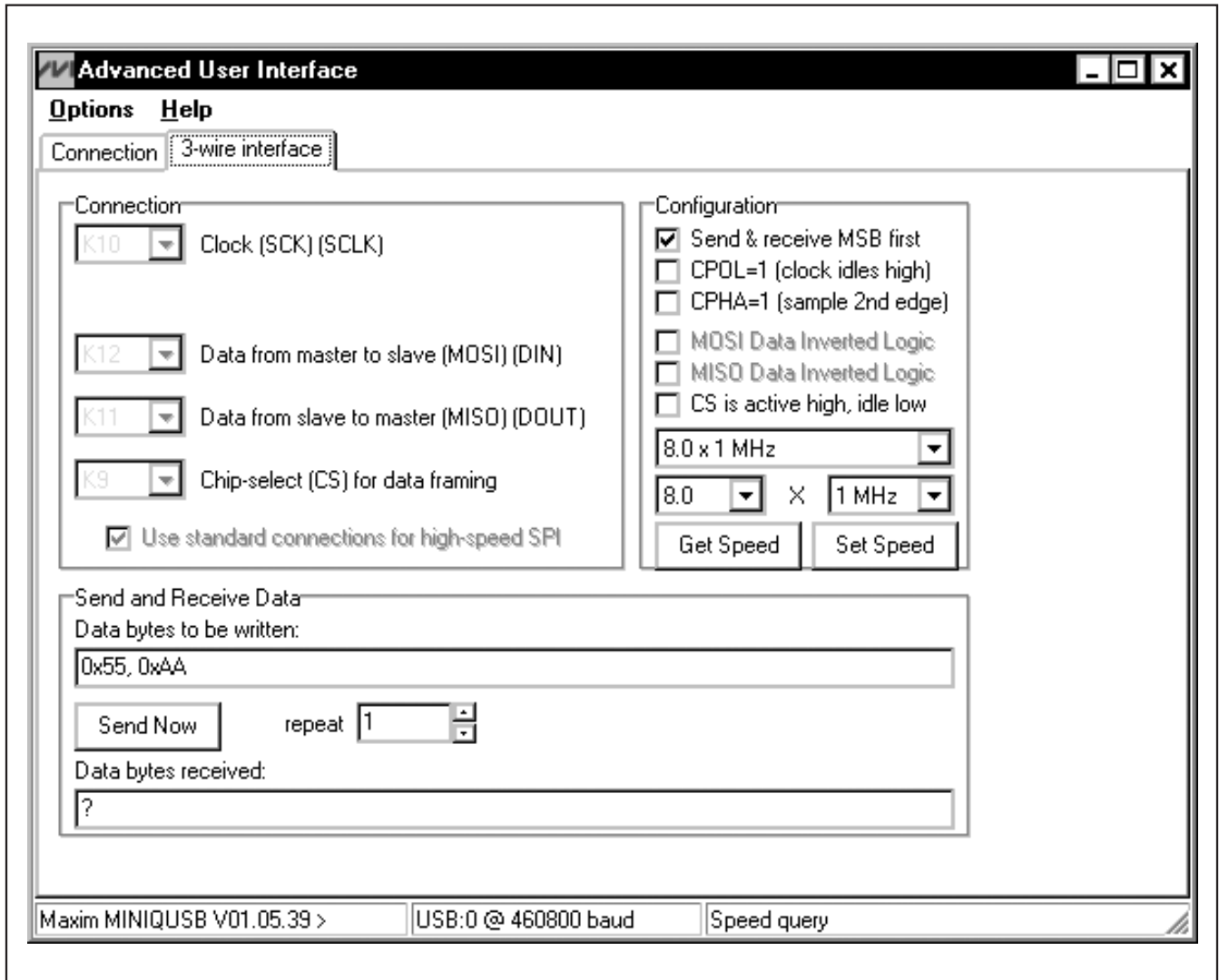

Figure 3. Advanced User Interface Window (3-Wire Interface Tab)

MAX5258 Evaluation Kit

Reference

At power-up, the MAX5258 EV kit defaults to using the on-board 4.096V reference.

To use VDD as the reference, place a shunt on jumper JU7 in the 1-2 position. For off-board external references,

Table 1. MAX5258 EV Kit Jumper Descriptions (JU1–JU7)

JUMPER	SHUNT POSITION	DESCRIPTION
JU1	1-2*	MAX5258 \overline{CS} signal connected to on-board microcontroller
	2-3	MAX5258 \overline{CS} signal connected to on-board header H3
JU2	1-2*	MAX5258 SCLK signal connected to on-board microcontroller
	2-3	MAX5258 SCLK signal connected to on-board header H3
JU3	1-2*	MAX5258 DIN signal connected to on-board microcontroller
	2-3	MAX5258 DIN signal connected to on-board header H3
JU4	1-2*	MAX5258 DOUT signal connected to on-board microcontroller
	2-3	MAX5258 DOUT signal connected to on-board header H3
JU5	1-2*	MAX5258 \overline{LDAC} signal connected to on-board microcontroller
	1-3	MAX5258 \overline{LDAC} signal connected to on-board header H3
JU6	1-2	MAX5258 VDD is set to the on-board +3.3V supply post regulated from the USB port
	1-3*	MAX5258 VDD is set to the on-board +5V supply powered directly from the USB port
	1-4	Connect an external 2.7V to 5.5V supply to the VDD pad
JU7	1-2	MAX5258 REF pin is connected directly to VDD
	1-3	Connect an external reference voltage to the REF pad
	1-4*	MAX5258 REF pin is connected to the on-board 4.096V reference

*Default position.

connect a user-supplied reference voltage to REF and place a shunt on jumper JU7 in the 1-3 position. Type in the reference voltage value in the **Set Vref** edit box and press the **Set Vref** button. The MAX5258 EV kit software uses the value in the **Set Vref** edit box to calculate the input and output register voltage values. The **Set Vref** edit box value does not affect the register values.

User-Supplied SPI Interface

To use the MAX5258 EV kit with a user-supplied SPI interface, set the shunts as shown in Table 2. Then apply an external 2.7V to 5.5V power supply to VDD. Lastly, connect user-supplied \overline{CS} , SCLK, DIN, DOUT, \overline{LDAC} , and GND signals to the corresponding pins of header H3.

User-Supplied Power Supplies

Table 2. User-Supplied SPI Interface Settings

JUMPER	SHUNT POSITION
JU1–JU5	2-3
JU6	1-4
JU7	1-2

The MAX5258 EV kit is powered completely from the USB port by default. Place jumper JU6 in the 1-4 position and apply an external 2.7V to 5.5V power supply across the corresponding VDD and GND pads. Lastly, see the *Reference* section to choose the best reference option.

MAX5258 Evaluation Kit

Evaluates: MAX5258/MAX5259

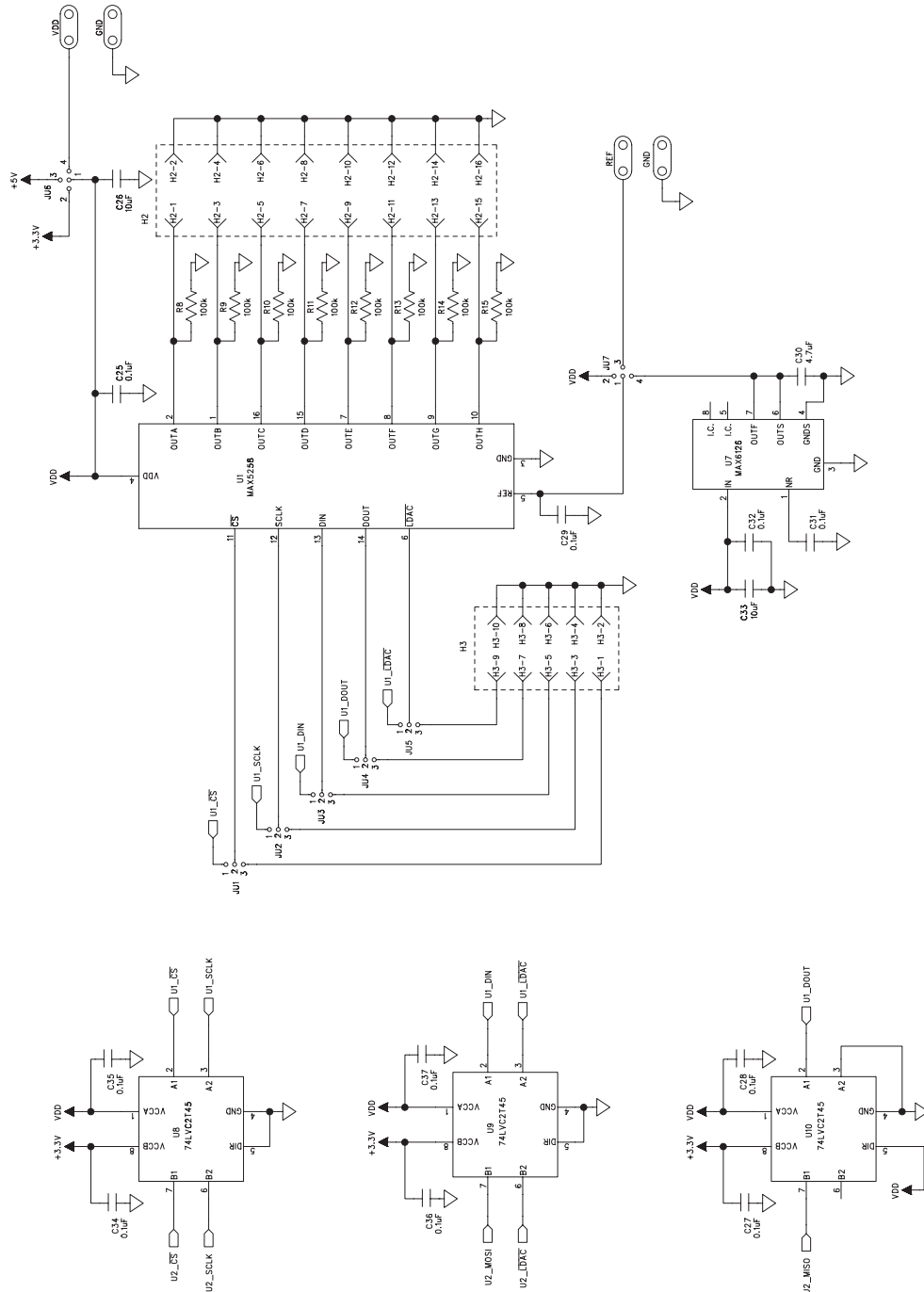

Figure 4a. MAX5258 EV Kit Schematic (Sheet 1 of 2)

MAX5258 Evaluation Kit

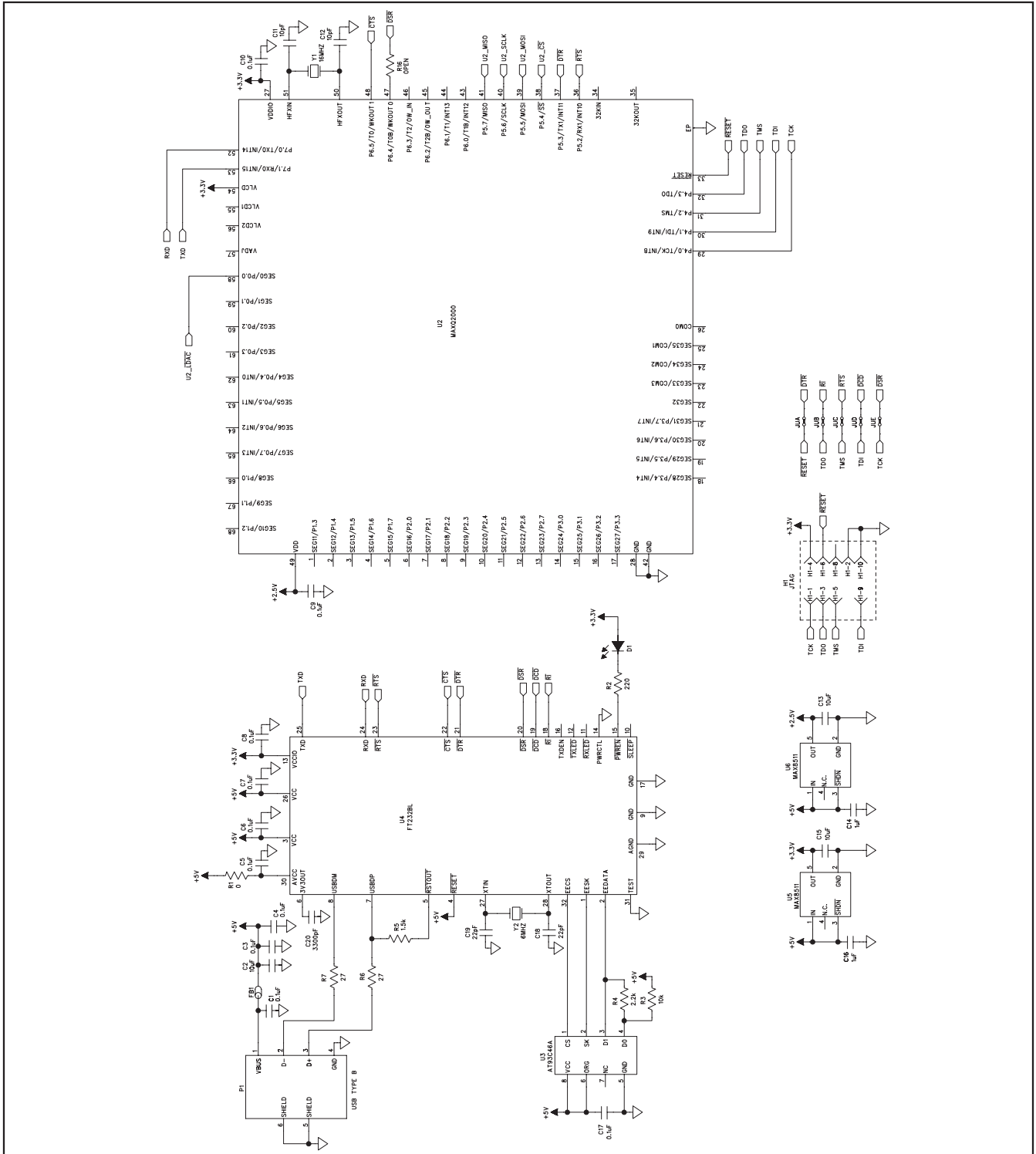

Figure 4b. MAX5258 EV Kit Schematic (Sheet 2 of 2)

MAX5258 Evaluation Kit

Evaluates: MAX5258/MAX5259

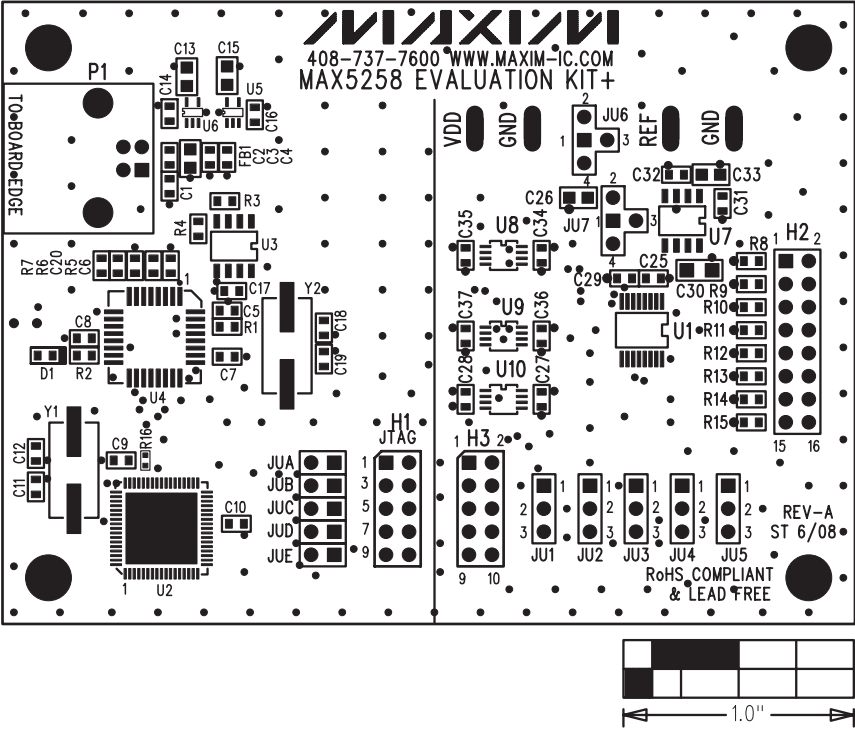

Figure 5. MAX5258 EV Kit Component Placement Guide—Component Side

MAX5258 Evaluation Kit

Evaluates: MAX5258/MAX5259

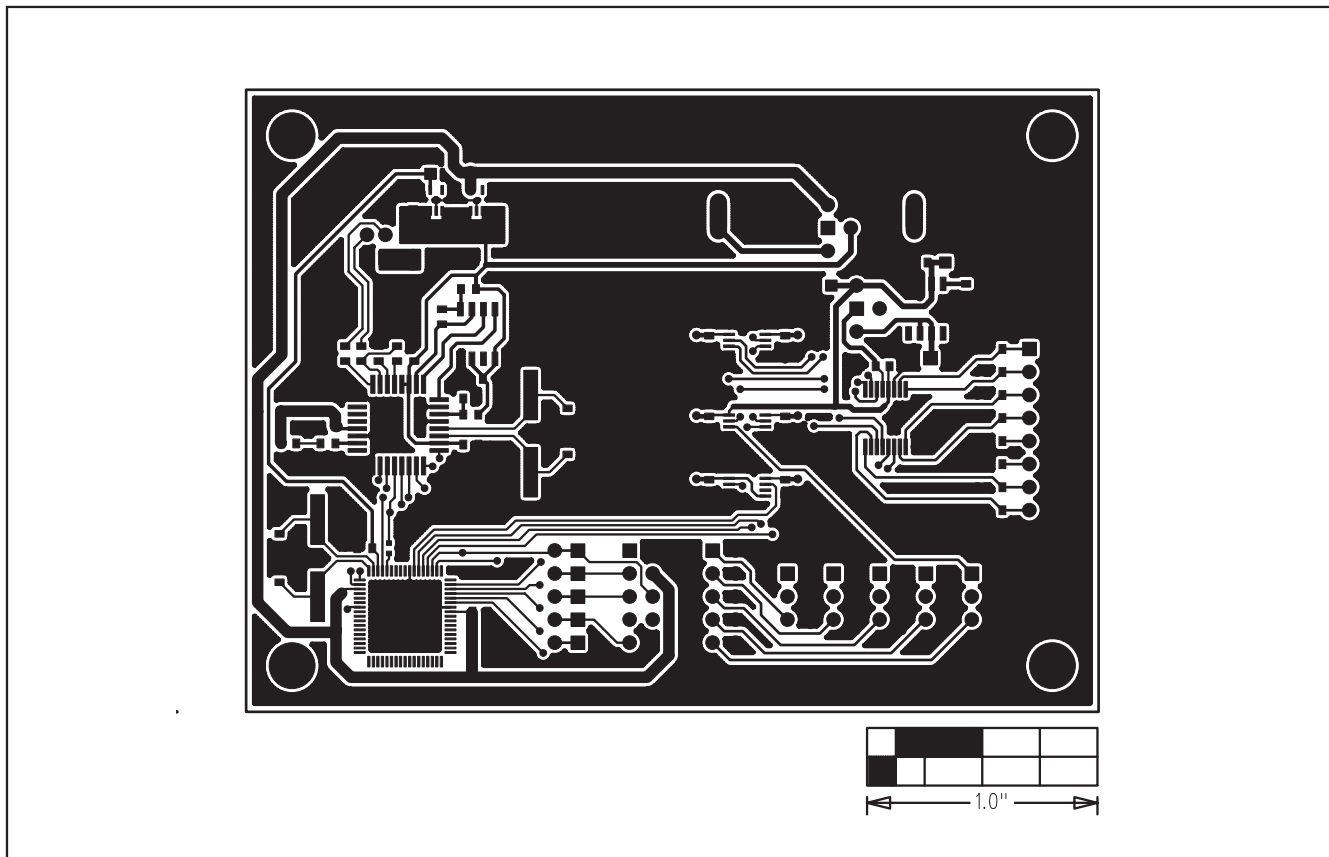

Figure 6. MAX5258 EV Kit PCB Layout—Component Side

MAX5258 Evaluation Kit

Evaluates: MAX5258/MAX5259

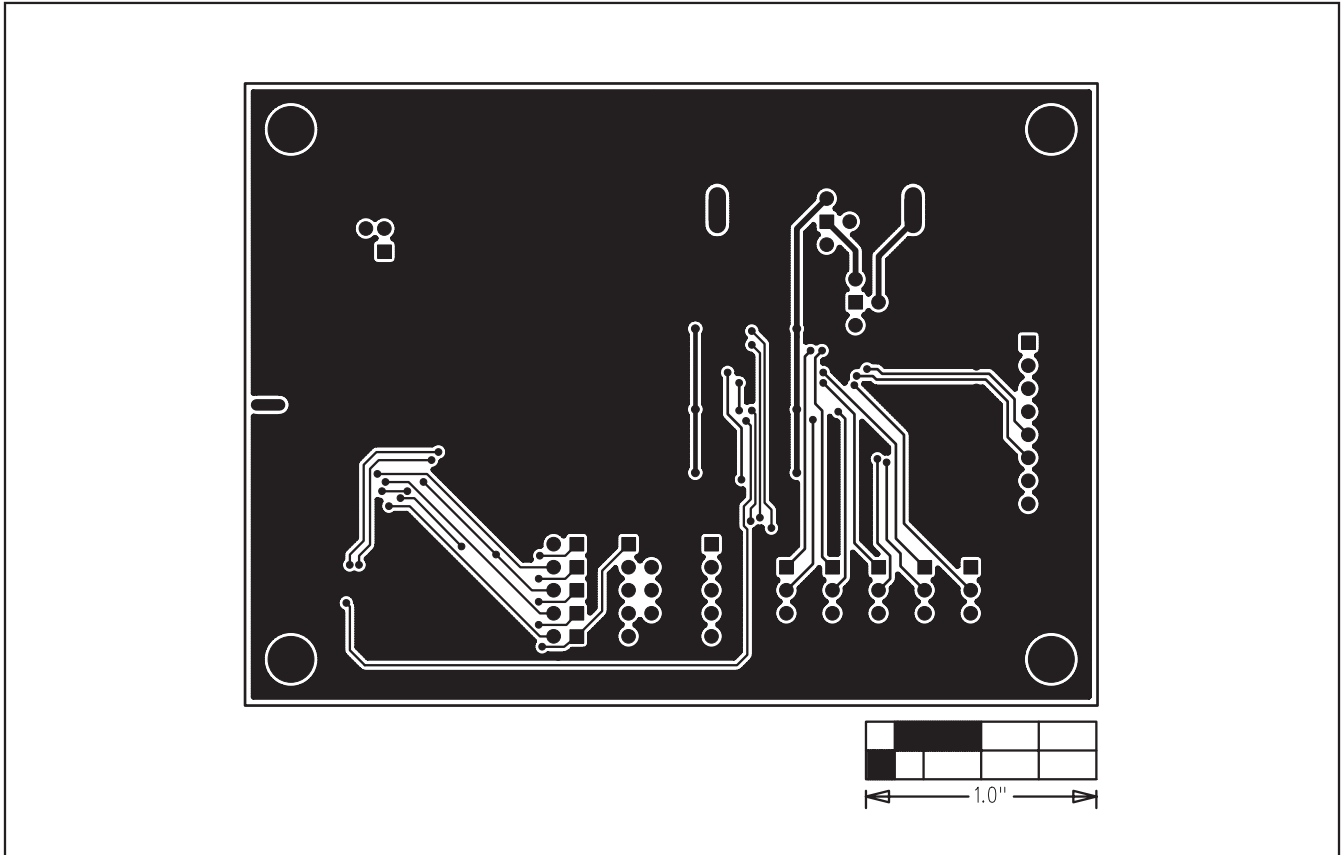

Figure 7. MAX5258 EV Kit PCB Layout—Solder Side

Maxim cannot assume responsibility for use of any circuitry other than circuitry entirely embodied in a Maxim product. No circuit patent licenses are implied. Maxim reserves the right to change the circuitry and specifications without notice at any time.

Maxim Integrated Products, 120 San Gabriel Drive, Sunnyvale, CA 94086 408-737-7600 _____ 11