

# Six-Pack SPT+ IGBT

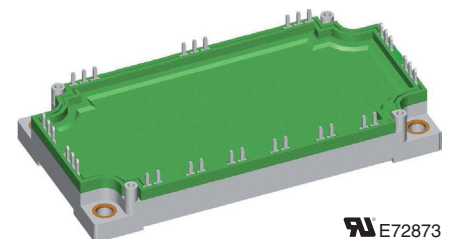
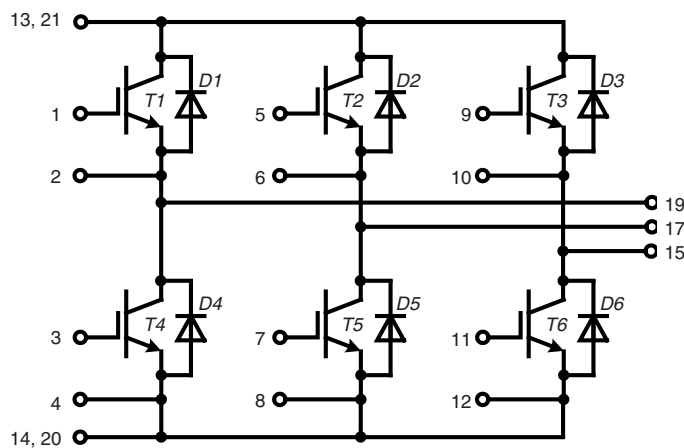
$$V_{CES} = 1200 \text{ V}$$

$$I_{C25} = 183 \text{ A}$$

$$V_{CE(sat)} = 1.8 \text{ V}$$

**Part name** (Marking on product)

MIEB101W1200EH



### Features:

- SPT+ IGBT technology
- low saturation voltage
- low switching losses
- square RBSOA, no latch up
- high short circuit capability
- positive temperature coefficient for easy paralleling
- MOS input, voltage controlled
- SONIC™ free wheeling diode
  - fast and soft reverse recovery
  - low operation forward voltage
- solderable pins for PCB mounting
- package with copper base plate

### Application:

- AC motor drives
- Solar inverter
- Medical equipment
- Uninterruptible power supply
- Air-conditioning systems
- Welding equipment
- Switched-mode and resonant-mode power supplies

### Package:

- "E3-Pack" standard outline
- Insulated copper base plate
- Soldering pins for PCB mounting

**Output Inverter T1 - T6**

Symbol	Definitions	Conditions	Ratings			Unit	
			min.	typ.	max.		
$V_{CES}$	collector emitter voltage		$T_{VJ} = 25^{\circ}\text{C}$		1200	V	
$V_{GES}$	max. DC gate voltage	continuous			$\pm 20$	V	
$V_{GEM}$	max. transient collector gate voltage	transient			$\pm 30$	V	
$I_{C25}$	collector current		$T_C = 25^{\circ}\text{C}$		183	A	
$I_{C80}$			$T_C = 80^{\circ}\text{C}$		128	A	
$P_{tot}$	total power dissipation		$T_C = 25^{\circ}\text{C}$		630	W	
$V_{CE(sat)}$	collector emitter saturation voltage (on chip level) ①	$I_C = 100\text{ A}; V_{GE} = 15\text{ V}$	$T_{VJ} = 25^{\circ}\text{C}$ $T_{VJ} = 125^{\circ}\text{C}$	1.8 2.0	2.2 2.4	V V	
$V_{GE(th)}$	gate emitter threshold voltage	$I_C = 4\text{ mA}; V_{GE} = V_{CE}$	$T_{VJ} = 25^{\circ}\text{C}$	5	6	7	V
$I_{CES}$	collector emitter leakage current	$V_{CE} = V_{CES}; V_{GE} = 0\text{ V}$	$T_{VJ} = 25^{\circ}\text{C}$ $T_{VJ} = 125^{\circ}\text{C}$		0.3 3	mA mA	
$I_{GES}$	gate emitter leakage current	$V_{GE} = \pm 20\text{ V}$			200	nA	
$C_{ies}$	input capacitance	$V_{CE} = 25\text{ V}; V_{GE} = 0\text{ V}; f = 1\text{ MHz}$		7430		pF	
$Q_{G(on)}$	total gate charge	$V_{CE} = 600\text{ V}; V_{GE} = 15\text{ V}; I_C = 100\text{ A}$		750		nC	
$t_{d(on)}$	turn-on delay time	inductive load $V_{CE} = 600\text{ V}; I_C = 100\text{ A}$ $V_{GE} = \pm 15\text{ V}; R_G = 10\ \Omega$ $L_S = 70\text{ nH}$	$T_{VJ} = 125^{\circ}\text{C}$	120		ns	
$t_r$	current rise time			55		ns	
$t_{d(off)}$	turn-off delay time			460		ns	
$t_f$	current fall time			240		ns	
$E_{on}$	turn-on energy per pulse			9.5		mJ	
$E_{off}$	turn-off energy per pulse			9.7		mJ	
$E_{rec(off)}$	reverse recovery losses at turn-off			4.2		mJ	
<b>RBSOA</b>	reverse bias safe operating area	$V_{GE} = \pm 15\text{ V}; R_G = 10\ \Omega;$	$T_{VJ} = 125^{\circ}\text{C}$ $V_{CEK} = 1200\text{ V}$		200	A	
<b>SCSOA</b>	short circuit safe operating area						
$t_{SC}$	short circuit duration	$V_{CE} = 900\text{ V}; V_{GE} = \pm 10\text{ V};$	$T_{VJ} = 125^{\circ}\text{C}$		10	$\mu\text{s}$	
	short circuit current	$R_G = 3.9\ \Omega; \text{non-repetitive}$					
$R_{thJC}$	thermal resistance junction to case	(per IGBT)			0.2	K/W	

**Output Inverter D1 - D6**

Symbol	Definitions	Conditions	Ratings			Unit
			min.	typ.	max.	
$V_{RRM}$	max. repetitive reverse voltage		$T_{VJ} = 25^{\circ}\text{C}$		1200	V
$I_{F25}$	forward current		$T_C = 25^{\circ}\text{C}$		135	A
$I_{F80}$			$T_C = 80^{\circ}\text{C}$		90	A
$V_F$	forward voltage (on chip level) ①	$I_F = 100\text{ A}; V_{GE} = 0\text{ V}$	$T_{VJ} = 25^{\circ}\text{C}$ $T_{VJ} = 125^{\circ}\text{C}$	2.00 1.95	2.20 2.25	V V
$I_{rr}$	max. reverse recovery current	inductive load $V_{CE} = 600\text{ V}; I_C = 100\text{ A}$ $V_{GE} = \pm 15\text{ V}; R_G = 10\ \Omega$ $L_S = 70\text{ nH}$	$T_{VJ} = 125^{\circ}\text{C}$	120		A
$t_{rr}$	reverse recovery time			330		ns
$Q_{rr}$				12.5		$\mu\text{C}$
$E_{rec}$				4.2		mJ
$R_{thJC}$	thermal resistance junction to case	(per diode)			0.4	K/W

 $T_C = 25^{\circ}\text{C}$  unless otherwise stated

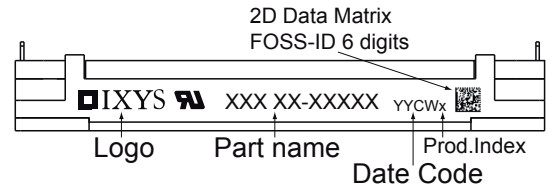
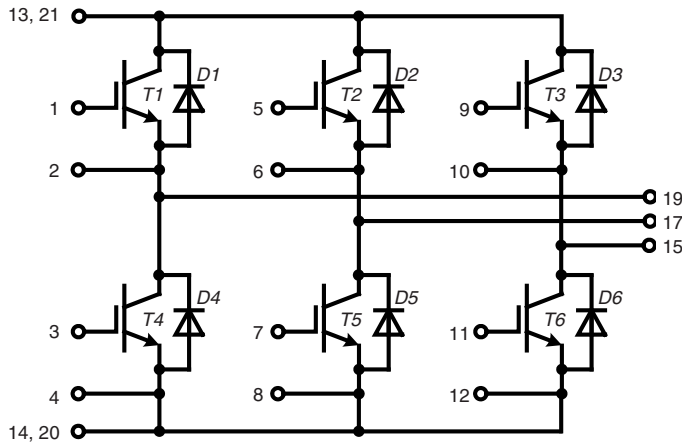
Module				Ratings		
Symbol	Definitions	Conditions	min.	typ.	max.	Unit
$T_{VJ}$	operating temperature		-40		125	°C
$T_{VJM}$	max. virtual junction temperature				150	°C
$T_{stg}$	storage temperature		-40		125	°C
$V_{ISOL}$	isolation voltage	$I_{ISOL} \leq 1 \text{ mA}; 50/60 \text{ Hz}$ $t = 1 \text{ min}$ $t = 1 \text{ s}$			3000 3600	V~ V~
<b>CTI</b>	comparative tracking index				200	
$M_d$	mounting torque (M5)		3		6	Nm
$R_{pin \text{ to chip}}$	see ①			1.8		mΩ
$d_S$	creep distance on surface		12.7			mm
$d_A$	strike distance through air		9.6			mm
$R_{thCH}$	thermal resistance case to heatsink	with heatsink compound		0.1		K/W
<b>Weight</b>				300		g

①  $V_{CE} = V_{CE(sat)} + 2x R_{pin \text{ to chip}} \cdot I_C$

$T_C = 25^\circ\text{C}$  unless otherwise stated

Curves are measured on modul level except Fig. 14 to Fig. 17

## Circuit Diagram

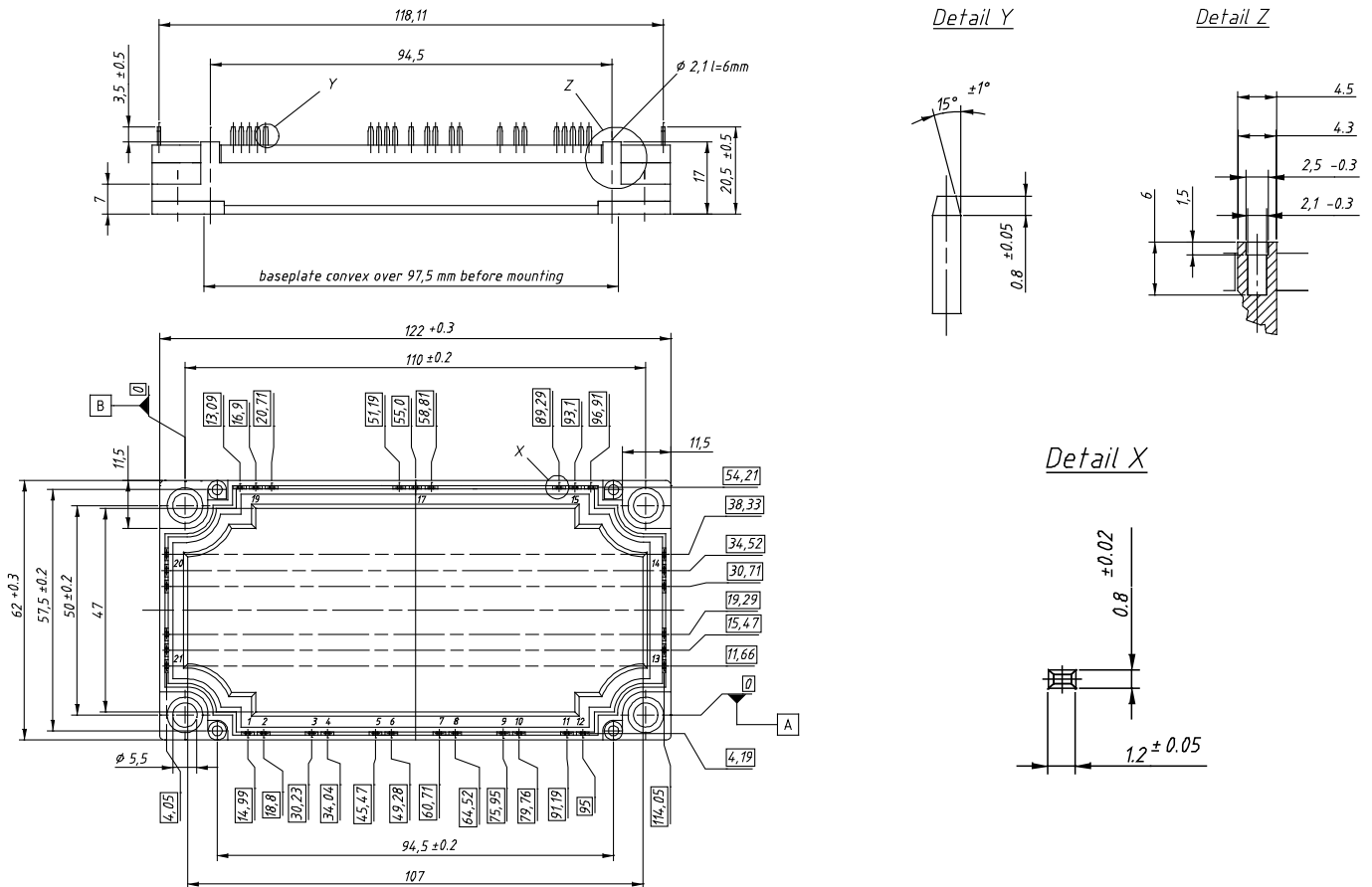


### Part number

- M = Module
- I = IGBT
- E = SPT
- B = 2nd Generation
- 101 = Current Rating [A]
- W = Six-Pack
- 1200 = Reverse Voltage [V]
- EH = E3-Pack

## Outline Drawing

Dimensions in mm (1 mm = 0.0394")



## Product Marking

Ordering	Part Name	Marking on Product	Delivering Mode	Base Qty	Ordering Code
Standard	MIEB101W1200EH	MIEB101W1200EH	Box	5	509522

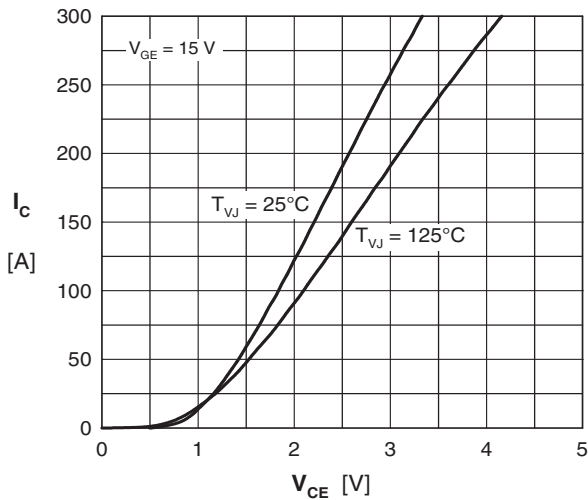
**Transistor T1 - T6**


Fig. 1 Typ. output characteristics

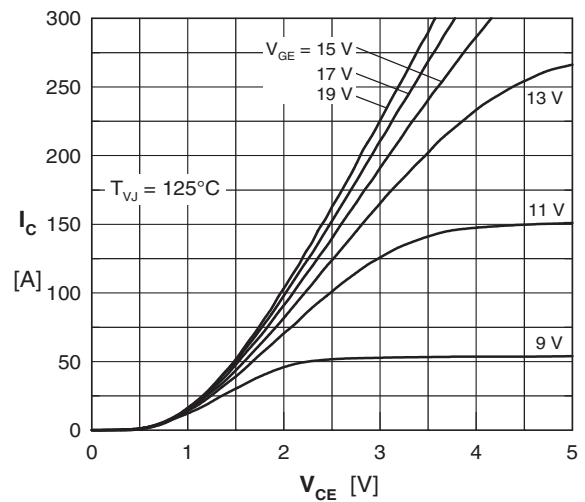


Fig. 2 Typ. output characteristics

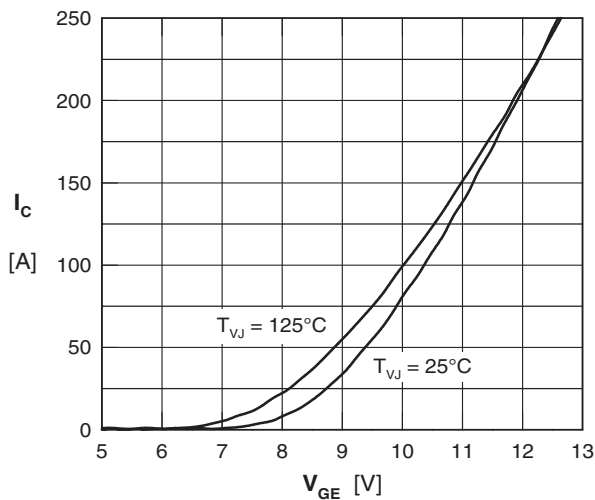


Fig. 3 Typ. transfer characteristics

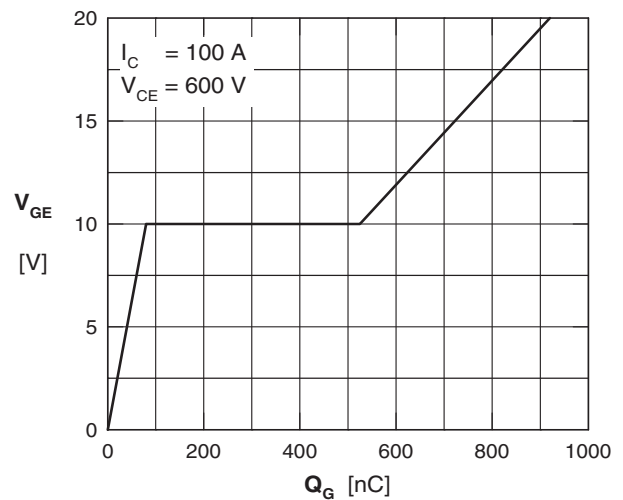


Fig. 4 Typ. turn-on gate charge

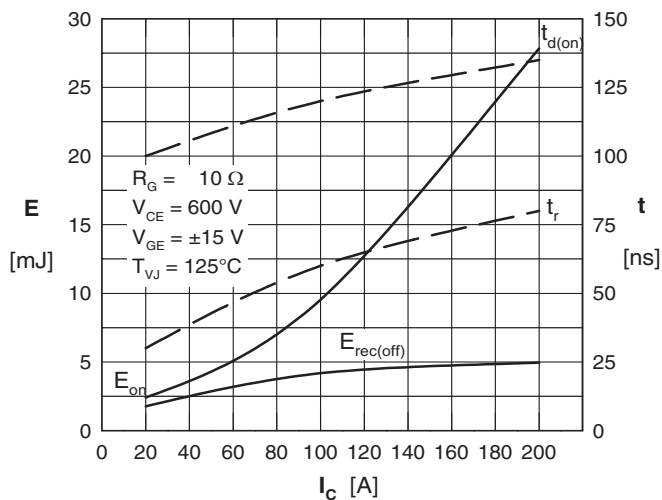


Fig. 5 Typ. turn-on energy &amp; switching times versus collector current

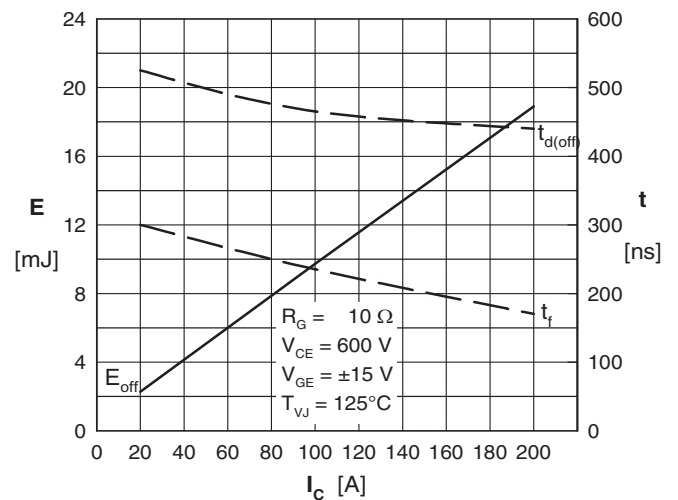


Fig. 6 Typ. turn-off energy &amp; switching times versus collector current

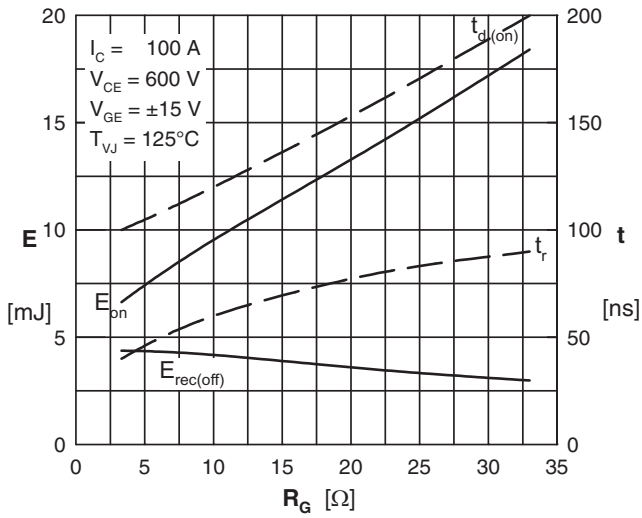
**Transistor T1 - T6**


Fig. 7 Typ. turn-on energy and switching times versus gate resistor

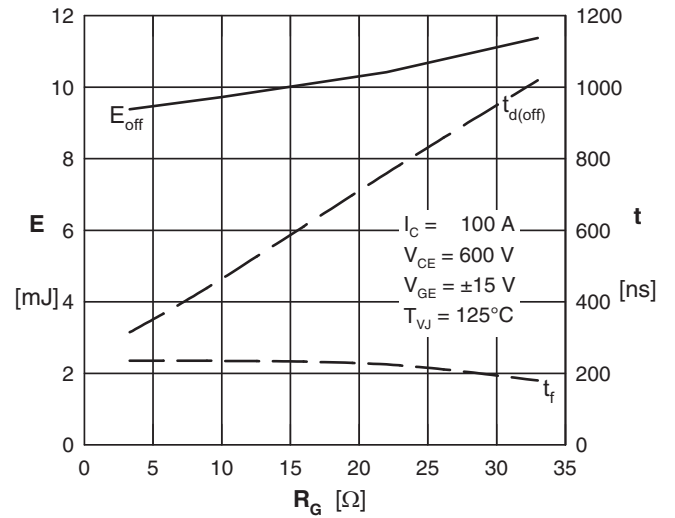


Fig. 8 Typ. turn-off energy and switching times versus gate resistor

## Diode D1 - D6

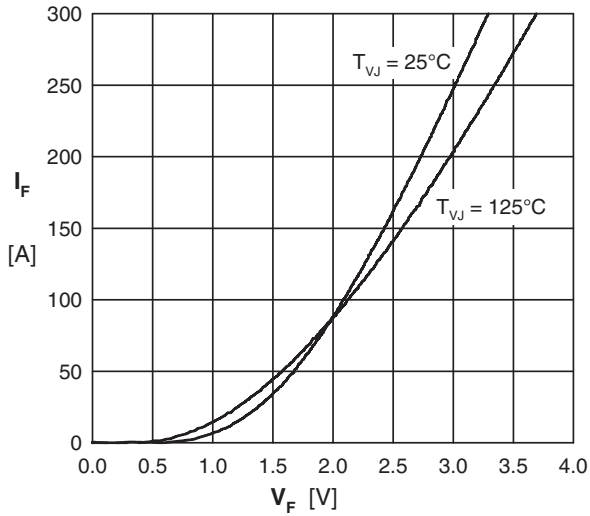


Fig. 9 Typ. forward characteristics

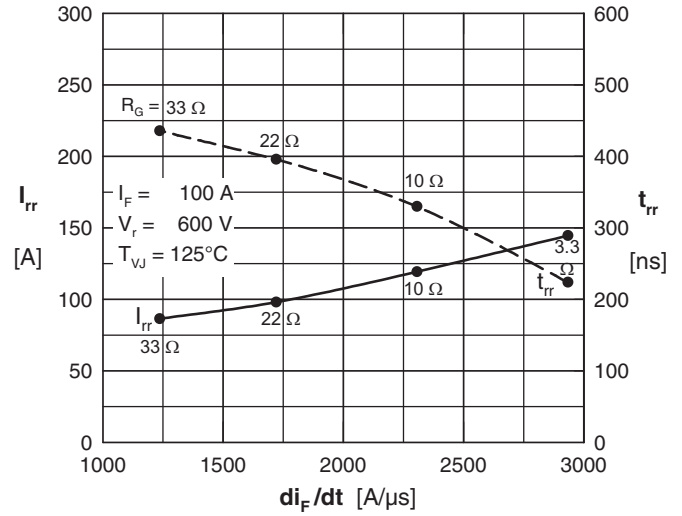


Fig. 10 Typ. reverse recovery characteristics

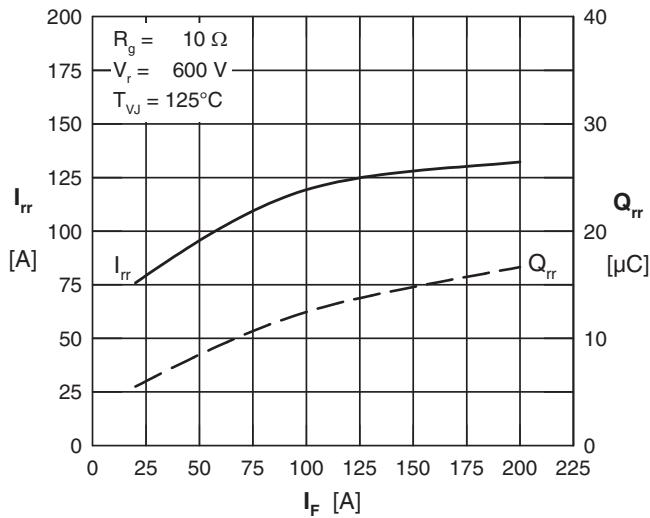


Fig. 11 Typ. reverse recovery characteristics

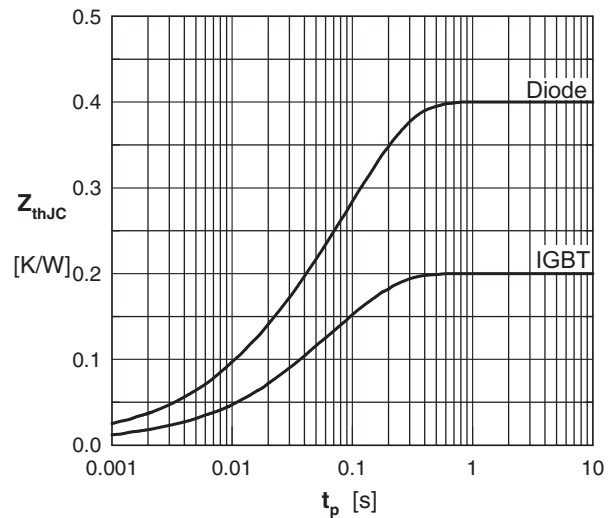


Fig. 12 Typ. transient thermal impedance

IGBT		FRD	
$R_i$	$\tau_i$	$R_i$	$\tau_i$
0.003	0.00001	0.015	0.0005
0.010	0.0014	0.04	0.006
0.057	0.021	0.09	0.025
0.130	0.1	0.255	0.125

Fig. 13 Thermal coefficients

**Diode D1 - D6**

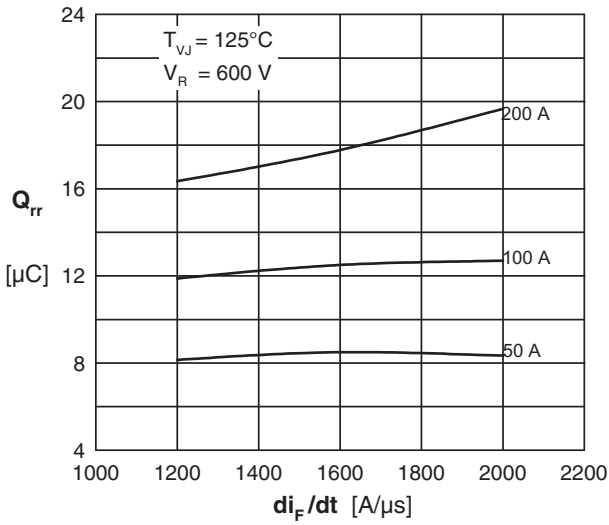


Fig. 14 Typ. reverse recov.charge  $Q_{rr}$  vs.  $di/dt$

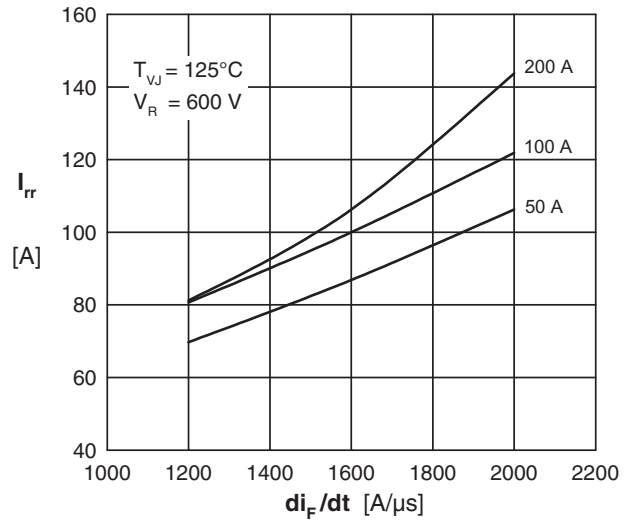


Fig. 15 Typ. peak reverse current  $I_{RM}$  vs.  $di/dt$

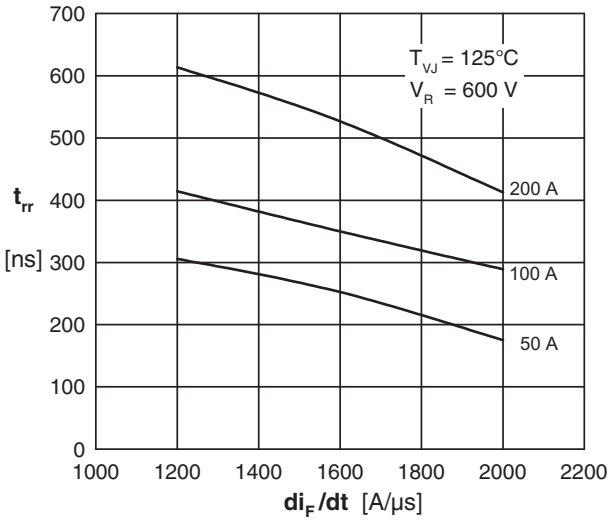


Fig. 16 Typ. recovery time  $t_{rr}$  versus  $di/dt$

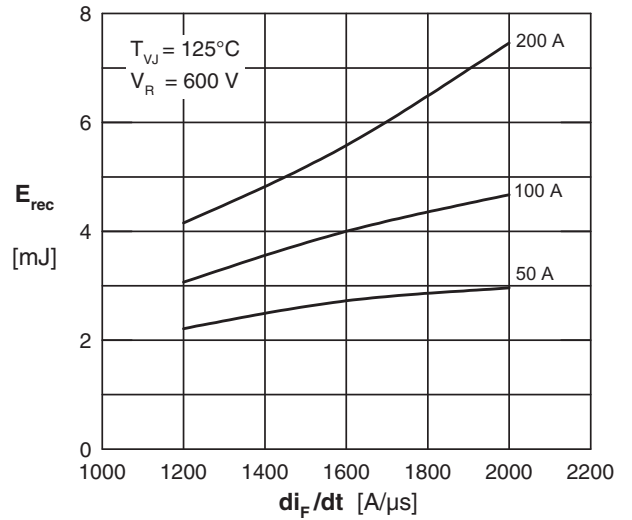


Fig. 17 Typ. recovery energy  $E_{rec}$  versus  $di/dt$