

PART NAME

JUNCTION BOX

PART No.

JB-3945

REVISION DATE

7-18-11

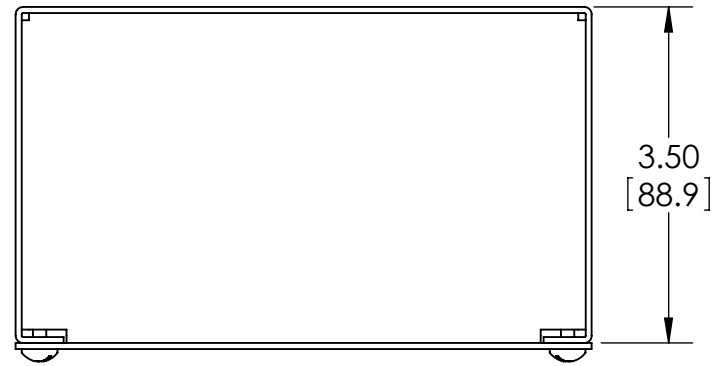

MATERIAL - 16 GA. [1.5mm] STEEL
 FINISH - SMOOTH GRAY POWDERCOAT

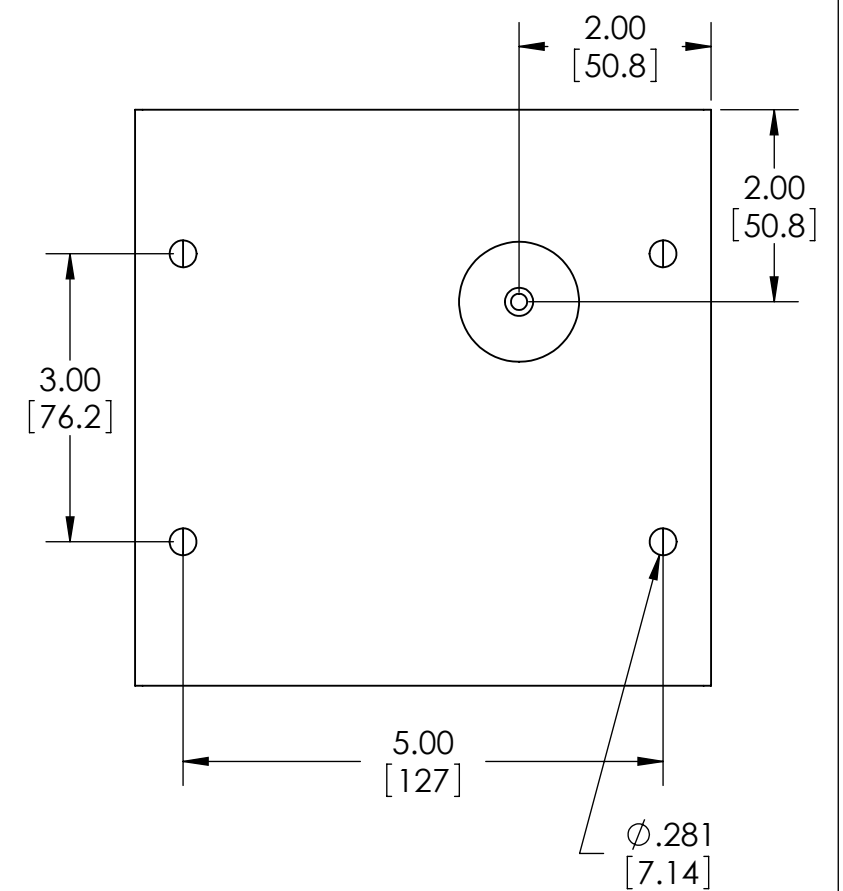
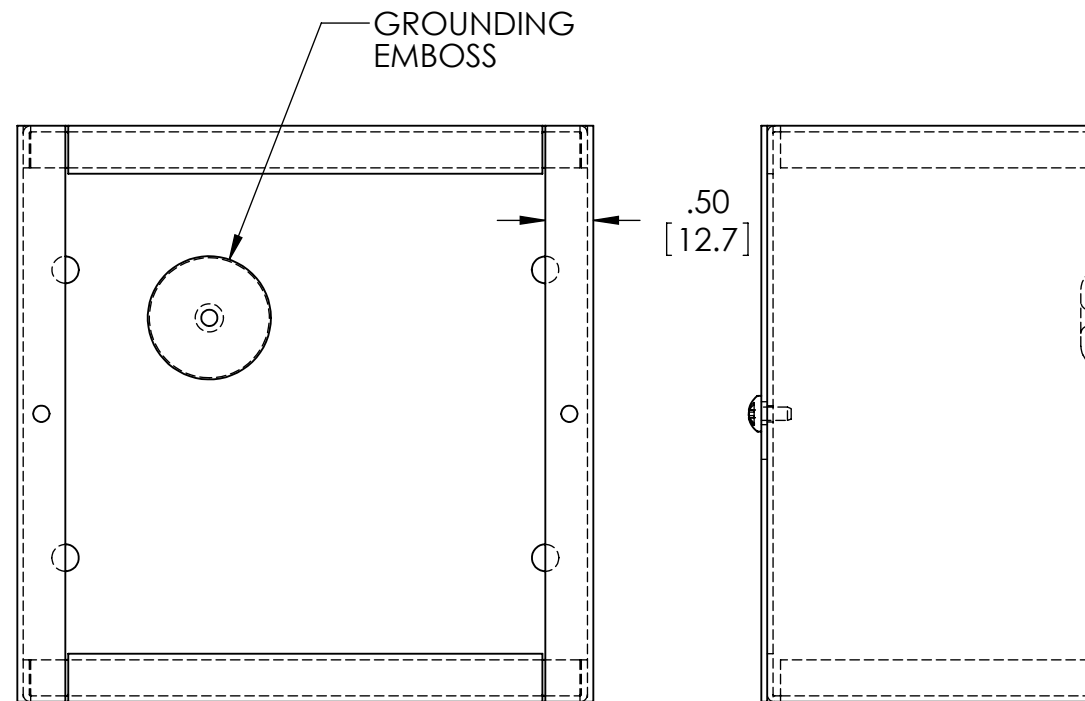
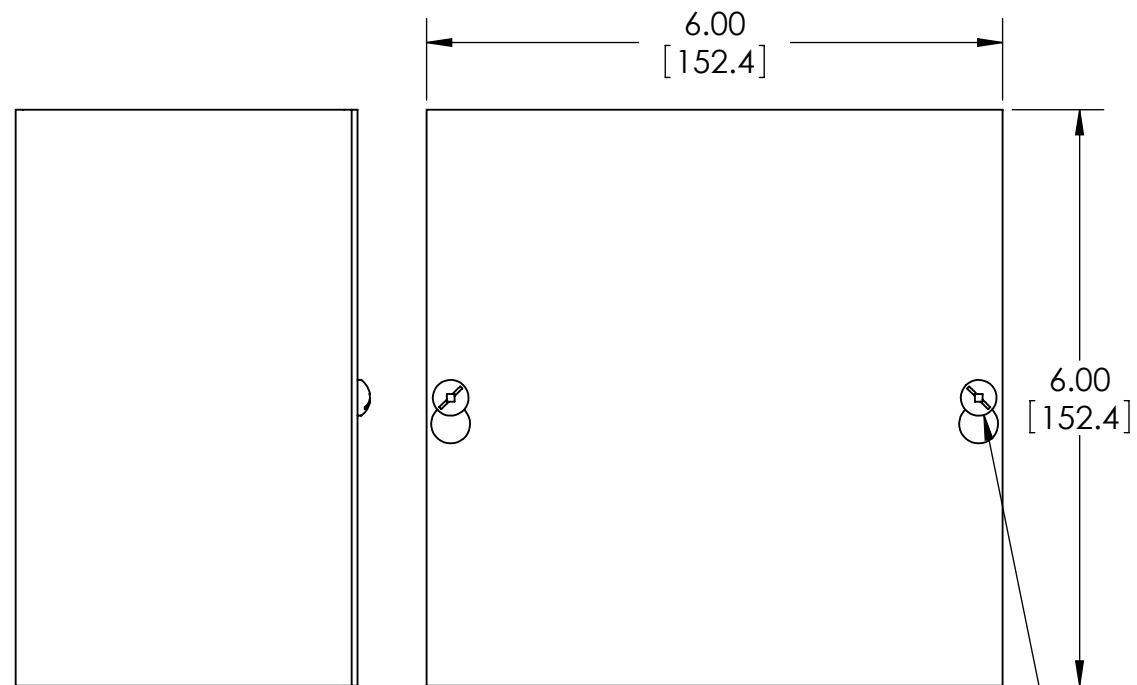
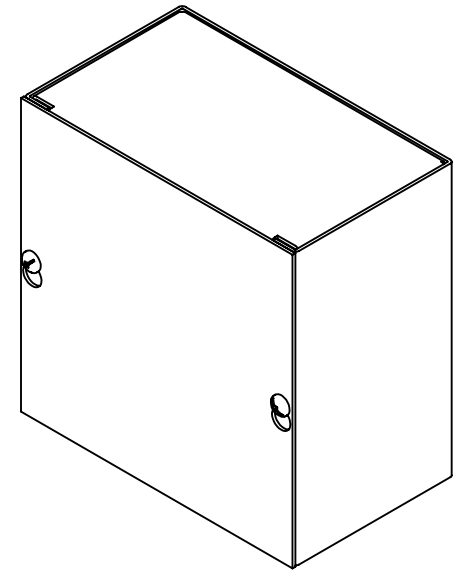

SCREWS: #10-32 x .31"[8mm] LG.
 MACHINE, PAN HEAD, SLOTTED/SQUARE
 COMBINATION STYLE DRIVE, STEEL, ZINC PLATED.
 (SUPPLIED FOR COVER MOUNTING AND
 FOR GROUND POINT).

