

# SDDJE 10A 250V AC Qualified Type

100A inrush current compatible, compact and large capacity snap-in type with easy mounting



## Ratings and Safety Standards

Items	Specifications
C-UL-US	10AGP 250V AC
SEMKO	6A / 96A 250V~, 10(6) / 250~
VDE	6A / 96A 250V~, 10(6) / 250~
BS	6A / 96A 250V~, 10(6) / 250~
Ratings satisfying local electrical appliance and material safety law	125V 10A $\nabla$

## Product Line

Circuit arrangement	Travel (mm)	Operating force	Mounting method	Terminal configuration	Frame	Marking (Knob)	Minimum order unit (pcs.)		Product No.	Drawing No.					
							Japan	Export							
SPST	3±2N			For Lead	Without	Without	400	2,000	<b>SDDJE11600</b>	1					
				Right angle	With						250	1,250	<b>SDDJE12200</b>	2	
				For Lead	Without	● mark	400	2,000	<b>SDDJE10300</b>	1					
				Right angle	With						250	1,250	<b>SDDJE12300</b>	2	
				For Lead	Without	IO mark	400	2,000	<b>SDDJE10700</b>	1					
				Right angle	With						250	1,250	<b>SDDJE12400</b>	2	
				For Lead	Without	-O mark	400	2,000	<b>SDDJE11200</b>	1					
				Right angle	With						250	1,250	<b>SDDJE12500</b>	2	
				DPST	3.4	6±3N	Snap-in	For Lead	Without	Without	400	2,000	<b>SDDJE31600</b>	3	
								Right angle	With						250
								For Lead	Without	● mark	400	2,000	<b>SDDJE30100</b>	3	
								For PC board							Without
Right angle	With	250	1,250					<b>SDDJE30200</b>	4						
Right angle															<b>SDDJE32100</b>
For Lead	Without	IO mark	400					2,000	<b>SDDJE30300</b>	3					
For PC board											Without	<b>SDDJE33300</b>	6		
Right angle														With	250
Right angle	<b>SDDJE30400</b>										5				
For Lead	Without										-O mark	400	2,000	<b>SDDJE30700</b>	3

### Notes

1. The lead terminals are also used as tab terminals #187 (Use a positive lock connector type).
2. The lead terminal type can be mounted onto a board. (Manual soldering required)
3. Standard products apply Grade V-2 material (Flame Class). For Grade V-0 type please contact us.

**Packing Specifications**  
Tray

Product No.	Number of packages (pcs.)		Export package measurements (mm)
	1 case / Japan	1 case / export packing	
SDDJE11600, SDDJE10300, SDDJE10700, SDDJE11200, SDDJE31600, SDDJE30100, SDDJE32700, SDDJE30200, SDDJE30300, SDDJE33300, SDDJE30500, SDDJE30700	400	2,000	411×328×379
SDDJE12200, SDDJE12300, SDDJE12400, SDDJE12500, SDDJE32000, SDDJE32100, SDDJE30400	250	1,250	

**Dimensions**

Unit:mm

No.	Style (ON position)	
1	<p><b>For Lead (SPST)</b></p> <p>※This can also be used as a tab terminal(#187). Please use positive connector type.</p>	
2	<p><b>Right angle (SPST) With frame</b></p> <p>PC board mounting surface</p> <p>Mounting face</p> <p>PC board mounting hole dimensions</p>	
3	<p><b>For Lead (DPST)</b></p> <p>※This can also be used as a tab terminal(#187). Please use positive connector type.</p>	

Detector  
 Slide  
 Push  
 Rotary  
 Power  
 Dual-in-line Package Type  
 Push Type  
 Rocker Type  
 Slide Type  
 Rotary Type

## Dimensions

Unit:mm

No.	Style (ON position)	PC board mounting hole dimensions
4	<b>Right angle (DPST)</b> 	
5	<b>Right angle (DPST) With frame</b> 	
6	<b>For PC board (DPST)</b> 	

## Circuit Diagram

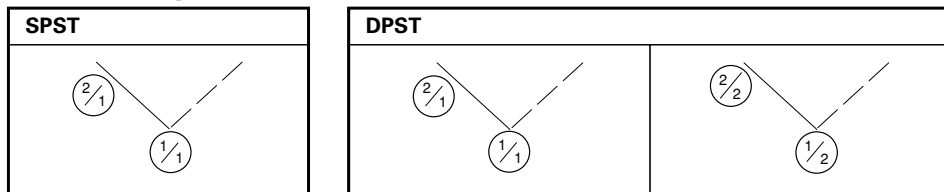

■ Mounting Hole Dimensions

Square-shaped Hole

		Unit:mm	
Thickness of mounting board	Y1	Z	
0.75 to 1.25	$19.2^{0}_{-0.1}$	$12.9^{+0.1}_{0}$	
1.25 to 2.00	$19.4^{0}_{-0.1}$		



U-shaped Hole

		Unit:mm	
Thickness of mounting board	Y2	Z	
0.75 to 1.1	$19.5^{0}_{-0.1}$	$12.9^{+0.1}_{0}$	
1.1 to 1.7	$19.7^{0}_{-0.1}$		
1.7 to 2	$19.9^{0}_{-0.1}$		

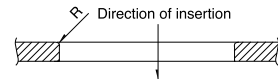
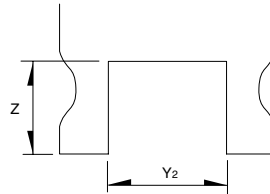

Note

Verify the performance under actual product conditions before use.



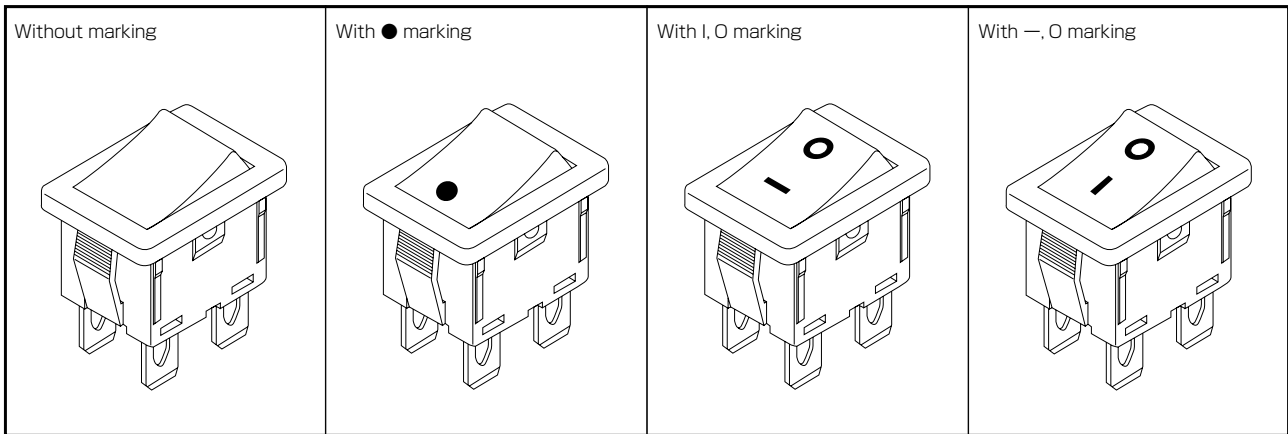







■ Marking Variety



Detector  
Slide  
Push  
Rotary  
Power  
Dual-in-line Package Type  
Push Type  
Rocker Type  
Slide Type  
Rotary Type

# Power Switches

## List of Varieties

Type		Push			Rocker		
Series		SDKR	SDDH	SDKN	SDDJE ※ 1 ※ 2	SDDJF ※ 1 ※ 2	
Photo							
Rating		0.5A 250V AC 1A 125V AC 10mA 5V DC	Rating (max.): 4.5A 12V DC (Lamp load: 27W×2) Rating (min.): 10mA 12V DC (Resistive load)	0.25A 250V AC 0.5A 125V AC 5mA 5V DC	10AGP 250V AC 6A / 96A 250V~	16AGP 250V AC 16 (6) / 250~	
Operating life		100,000cycles	100,000 cycles	5,200cycles	10,000cycles		
		0.5A 250V AC		0.25A 250V AC	10A 250V AC	16A 250V AC	
Travel (mm)		1.5	3.7	9 9.7	3.4	5.2	
Features		Water-proof type With signal circuit	Water-proof (IP68 rating)	—	—	—	
Operating temperature range		-10°C to +85°C	-15°C to +80°C	-20°C to +60°C	-10°C to +55°C		
Automotive use		—	●	—	—	—	
Life cycle (availability)							
Electrical performance	Contact resistance	100mΩ max. (AC switch) 500mΩ max. (DC switch)	500mΩ max.	100mΩ max.	100mΩ max.		
	Insulation resistance	500MΩ min. 500V DC (AC switch) 100MΩ min. 100V DC (DC switch)	10MΩ min. 500V DC	100MΩ min. 500V DC	500MΩ min. 500V DC		
	Voltage proof	1000V AC for 1minute (AC switch) 100V AC for 1minute (DC switch)	500V AC for 1minute	600V AC for 1minute	2,000V AC for 1minute		
Mechanical performance	Terminal strength	5N for 1minute	Slider pull-out strength: 100N min.	50N for 1minute	50N for 1minute (Lead terminal) 5N for 1minute (Right-angle terminal)	60N for 1minute (Lead terminal) 10N for 1minute (Right-angle terminal)	
	Actuator strength	Operating direction	100N	—	20N	25N	
		Perpendicular direction	20N	—	30N	25N	
Environmental performance	Cold	-20°C 240h	-15°C 96h	-30°C 192h	-20°C 96h		
	Dry heat	85°C 240h	80°C 96h	70°C 192h	85°C 96h		
	Damp heat	60°C, 90 to 95%RH 1000h	40°C, 90 to 95%RH 96h	40°C, 90 to 95%RH 192h	40°C, 90 to 95%RH 96h		
Page		152	153	154	156	160	

Power Switches Soldering Conditions	168
Power Switches Cautions	168
Power Switches Safety Standard	168

### Notes

- ※ 1. Dip soldering can be used on SDDJE for PC board terminal and SDDJF right angle terminal types only.
- ※ 2. The operating temperature range can be raised upon request. Please contact us for details.
- Indicates applicability to all products in the series.

## Reference for Hand Soldering

Series	Soldering temperature	Soldering time
SDDJE, SDDJF, SDKP, SDDJF1A, SDKZ, SDDE	350±10℃	3+1/0s
SDKR	300±10℃	3±0.5s

## Reference for Dip Soldering

(For PC board terminal types and SDDJF right-angle terminal types)

Series	Dip soldering	
	Soldering temperature	Duration of immersion
SDKR, SDDJE, SDDJF, SDKP, SDKZ, SDDE	260±5℃	10±1s

## Power Switches / Cautions

1. The primary power supply switching is subject to the safety regulations, and the provisions differ by each destination. Consult with us for non-standard use cases.
2. An unstable contact may occur if the switch current is lower than 0.5A. For this case, consult with us.
3. These power switches were produced for alternating current. For direct current, consult with us.
4. Applying load to terminals during soldering under certain conditions may cause deformation and electrical property degradation.
5. Avoid use of water-soluble soldering flux, since it may corrode the switches.
6. When soldering twice, wait until the first soldered portion cools to normal temperature. Continuous heating will deform the external portions, loosen or dislodge terminals, or may deteriorate their electrical characteristics.
7. Before soldering switches with locking mechanism, release the locks. If they are soldered without releasing the locks, the soldering heat may deform the locking mechanism.
8. Be sure to release the locks before removing the knobs. Otherwise, the locking mechanism may be broken.
9. Be sure to use the switch with forced travel positioned as close to the total travel as possible.
10. Tighten the mounting screws by applying the specified torque. Tightening with a larger torque than the specified will result in malfunction or breakage of screws.
11. Corrosive gas if generated by peripheral parts of a set, malfunction such as imperfect contact may occur. Thorough investigation shall be required beforehand.
12. Storage  
Store the products as delivered at normal temperature and humidity, out of direct sunlight and away from corrosive gases. Use them as soon as possible and no later than six months after delivery. Once the seal is broken, use them as soon as possible.

## Power Switches / Safety Standards

### 1. Safety Standards Outline

Safety standards are established by a country or an organization representing it to protect general users from electrical shock and fire hazards. It establishes standards for electrical devices and components. For electrical equipment manufacturers, utilizing switches that have been safety-approved ensures the safety of the switch. The use of a safety-approved switch also simplifies at least one part of the process of obtaining certification by safety testing.

### 2. Major Safety Standards

#### (1) Electrical Appliance and Material Safety Law

The conventional [Electrical Appliance and Material Control Law] has changed to [Electrical Appliance and Material Safety Law] and has been enforced since April 1, 2001. Electrical appliances are categorized into special electric appliances and parts (formerly Class A) and Electrical appliances other than the special electric appliances (formerly Class B). Special electric appliances are required to receive goodness of fit test at a certified test agency and to store the certificate. Also, penal provisions have been reinforced.

#### (2) UL (Underwriters Laboratories Inc.)

Underwriters Laboratories Inc. (UL) is the American safety approving organization. Its purpose is to ensure consumer safety and protect them from fire hazards. State law requires that equipment to be exported to the United States utilize UL approved power switches or power switches meeting UL standards and capable of passing UL tests.