

SPECIFICATION

- Part No. : **TS.07.0113**
- Product Name : Orange Straight TS.07
GPS/GLONASS/GALILEO/BeiDou Monopole
Passive Antenna
- Features : 1561-1610 MHz
72 ± 1.5mm Length
Standard with SMA(M) connector
Low profile
Extended operation temperature range (-40 to +85C)
Top quality housing with brass hinge and connector
Antenna must have a view of the Sky
ROHS Compliant



1. Introduction

The compact TS.07, with hinged rotatable SMA connector, is an impressively high efficiency monopole antenna, providing coverage among GPS, GLONASS, GAILEO, and BeiDou frequencies.

With its navigation system frequency range, plus compact design, TS.07 can fit and function perfectly with vehicle tracking devices, telematics devices, and other remote monitoring systems.

This 72mm long monopole antenna performs efficiently from 1561 MHz to 1610 MHz, covering GPS, GLONASS, GAILEO, and BeiDou frequencies. When connected to the device ground-plane, the TS.07 is capable of achieving more than 70% efficiency.

The TS.07, as all monopole antennas, works best when connected directly to the ground-plane of the device main-board or the device's metal enclosure. As with all passive antennas, using a coax with more than ~ 1.5 dB of loss will result in reduced receiver sensitivity. Taoglas recommends connecting the TS.07 directly to the device ground-plane for best performance.

The robust brass hinge enables the TS.07 to be oriented in all directions, providing user to maximize performance with minimum effort.

2. Specification

ELECTRICAL				
Straight Position				
Band		BEIDOU	GPS/GAILEO	GLONASS
Frequency (MHz)		1561	1575.42	1602
Average Gain (dBi)	In Free Space	-4.70	-4.48	-4.13
Efficiency (%)		33.89	35.65	38.66
Peak Gain (dBi)		-0.79	-0.55	-0.23
Return Loss (dB)		< -7		
Average Gain (dBi)	With 15x9cm Ground Plane	-1.53	-1.50	-1.41
Efficiency (%)		70.29	70.78	72.23
Peak Gain (dBi)		1.99	1.94	1.96
Return Loss (dB)		< -10		
Average Gain (dBi)	On 30x30cm Metal Plane Edge	-1.35	-1.41	-1.50
Efficiency (%)		73.20	72.35	70.81
Peak Gain (dBi)		4.05	4.04	3.98
Return Loss (dB)		< -10		
Average Gain (dBi)	On 30x30cm Metal Plane Center	-2.10	-2.22	-2.36
Efficiency (%)		61.66	60.02	58.05
Peak Gain (dBi)		2.26	2.15	2.21
Return Loss (dB)		< -4		

Bent Position				
Average Gain (dBi)	In Free Space	-5.31	-5.06	-4.68
Efficiency (%)		29.48	31.17	34.02
Peak Gain (dBi)		-0.82	-0.59	-0.16
Return Loss (dB)		< -7		
Average Gain (dBi)	With 15x9cm Ground Plane	-1.53	-1.50	-1.41
Efficiency (%)		70.29	70.78	72.23
Peak Gain (dBi)		1.99	1.94	1.96
Return Loss (dB)		< -10		
Average Gain (dBi)	On 30x30cm Metal Plane Edge	-1.12	-1.14	-1.17
Efficiency (%)		77.26	76.86	76.32
Peak Gain (dBi)		4.39	4.37	4.31
Return Loss (dB)		< -10		
Average Gain (dBi)	On 30x30cm Metal Plane Center	-2.50	-2.60	-2.73
Efficiency (%)		56.19	54.96	53.33
Peak Gain (dBi)		2.04	1.91	1.79
Return Loss (dB)		< -4		
Radiation		Omni-directional		
Polarization		Linear		
Impedance		50 Ω		
Input Power		10W		
MECHANICAL				
Antenna Length		72mm		
Antenna Diameter		10mm		
Casing		POM		
Connector		SMA(M)		
Weight		6g		
Recommended Torque for Mounting		0.9N·m		
Max. Torque for Mounting		1.176N·m		
ENVIRONMENTAL				
Operation Temperature		-40°C ~ + 85°C		
Storage Temperature		-40°C ~ + 85°C		
Humidity		Non-condensing 65°C 95% RH		

3. Antenna Characteristics

3.1 Testing setup

Antenna Straight Position



a) In free space

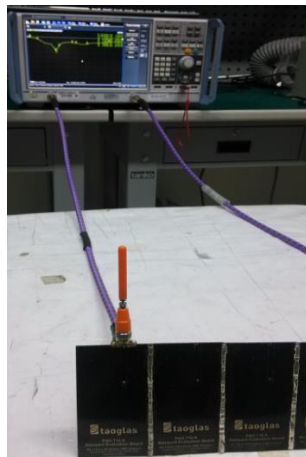

b) with 15*9cm Ground

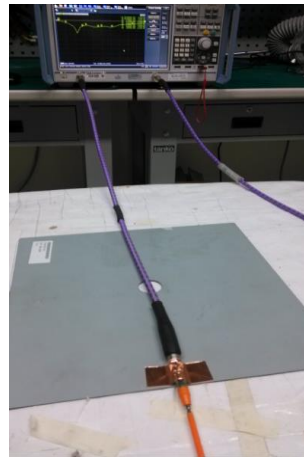

c) with 30*30cm Ground Metal Edge

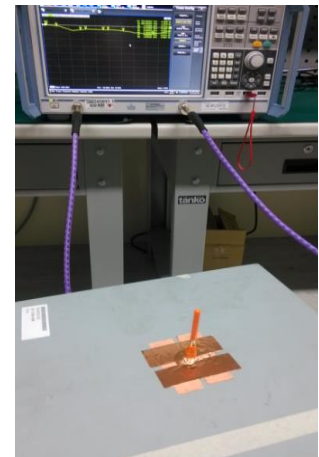

d) with 30*30cm Ground Metal Center

Antenna bent Position

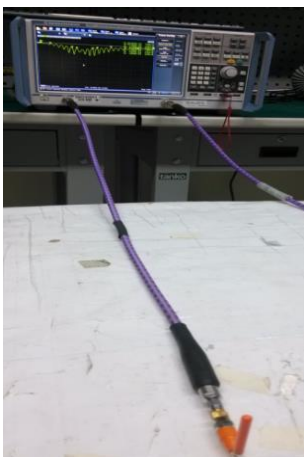

a) In free space

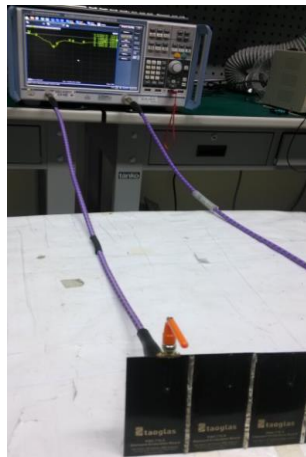

b) with 15*9cm Ground



c) with 30*30cm Ground Metal Edge

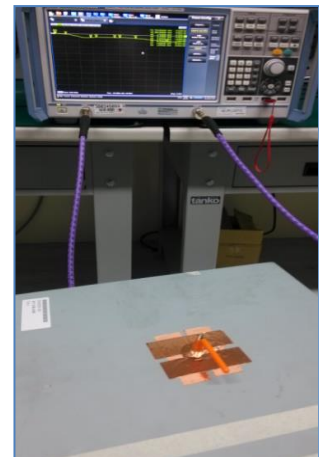

d) with 30*30cm Ground Metal Center

Figure.1 Measurement environments

3.2 Return loss

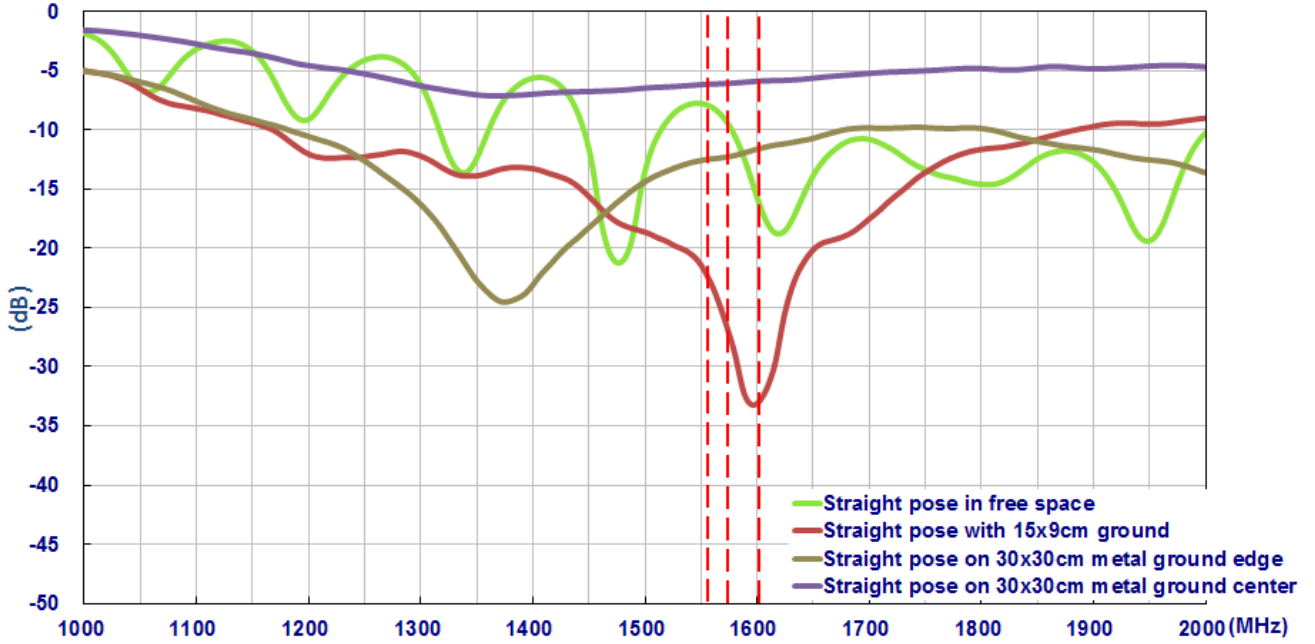

Figure2. Return loss of TS.07 antenna with straight Position

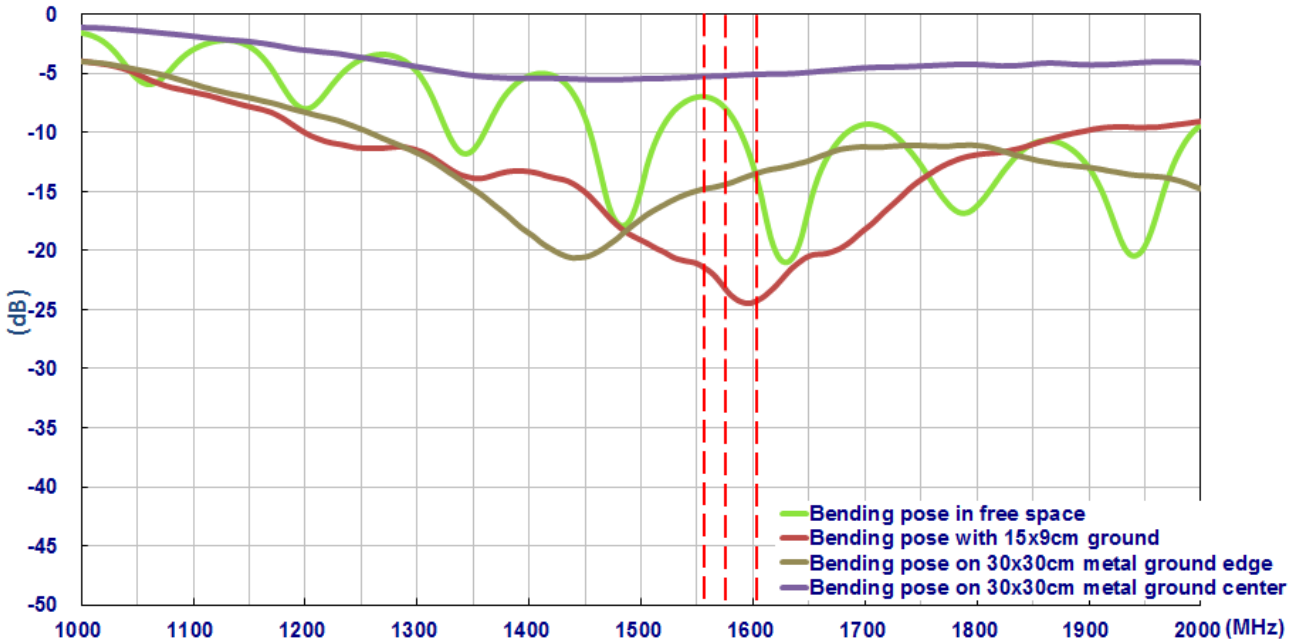

Figure3. Return loss of TS.07 antenna with bent Position

3.3 Efficiency

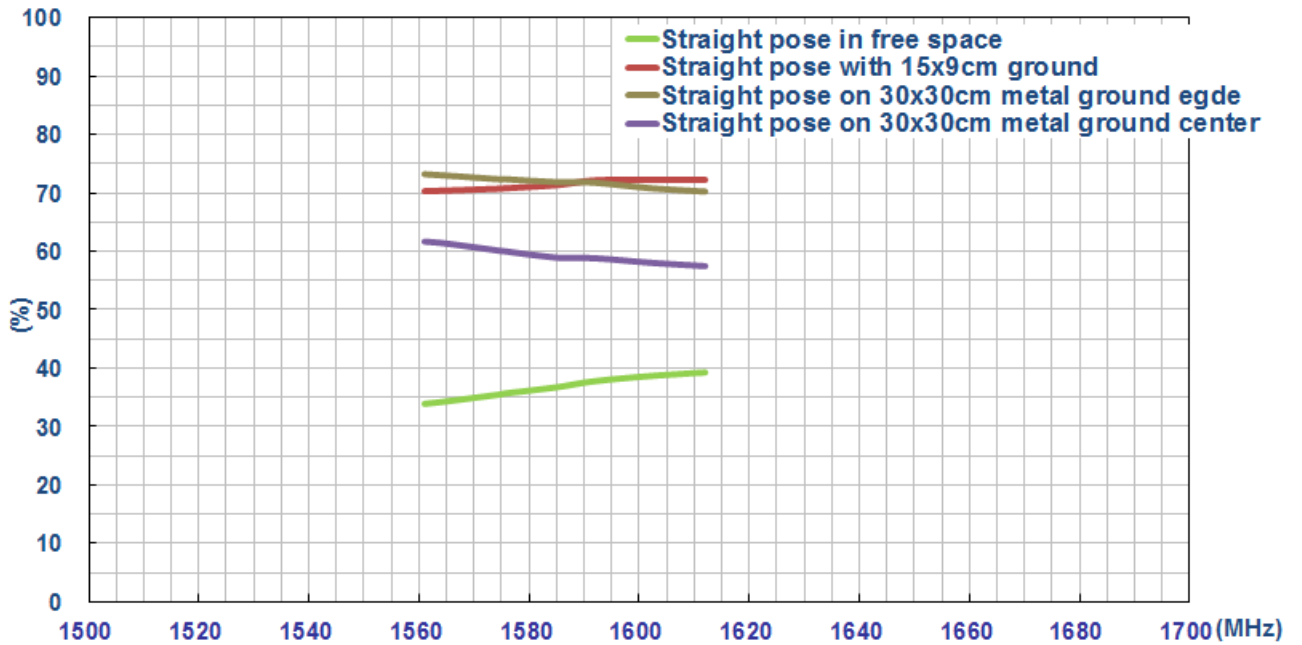

Figure4. Efficiency of TS.07 antenna with straight Position

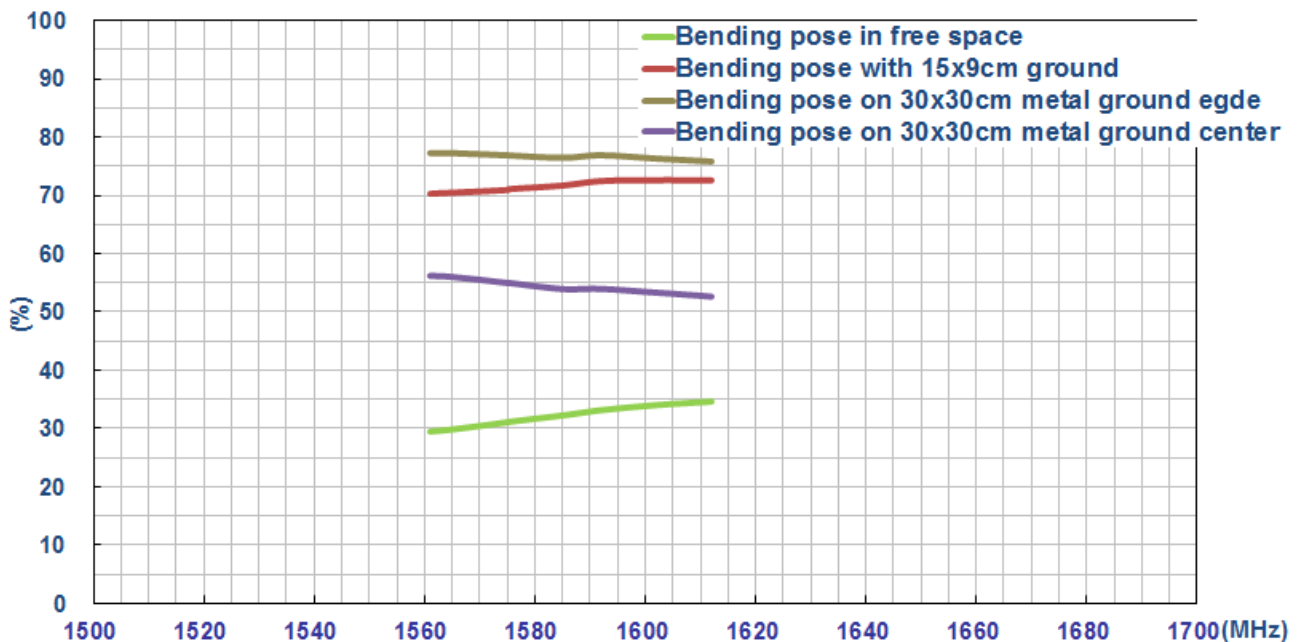

Figure5. Efficiency of TS.07 antenna with bent Position

3.4 Peak gain

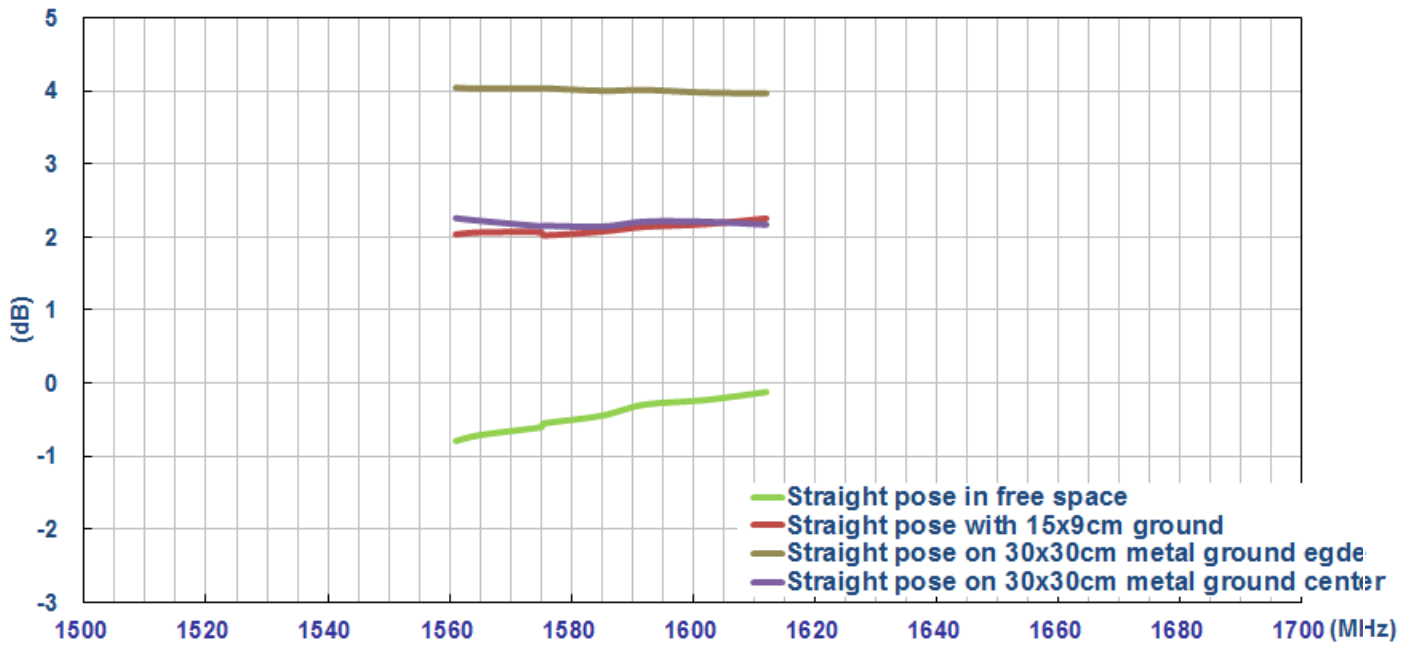

Figure6. Peak gain of TS.07 antenna with straight Position

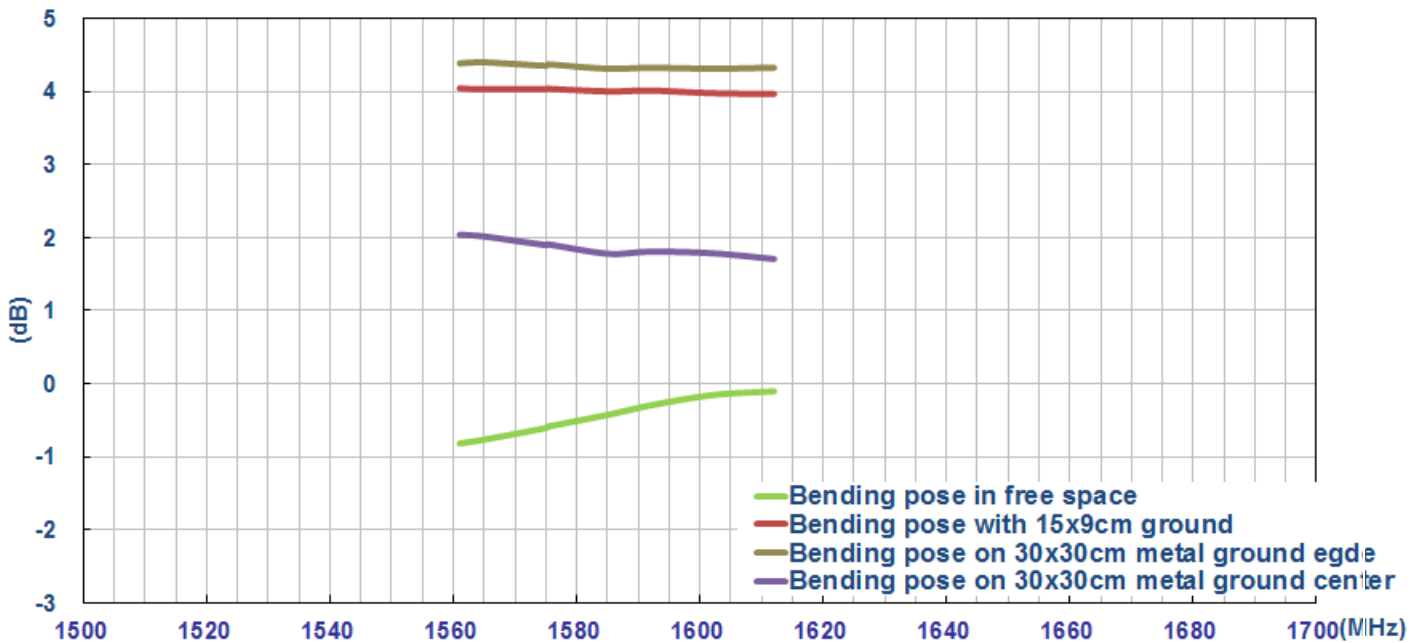

Figure7. Peak gain of TS.07 antenna with bent Position

3.5 Average gain

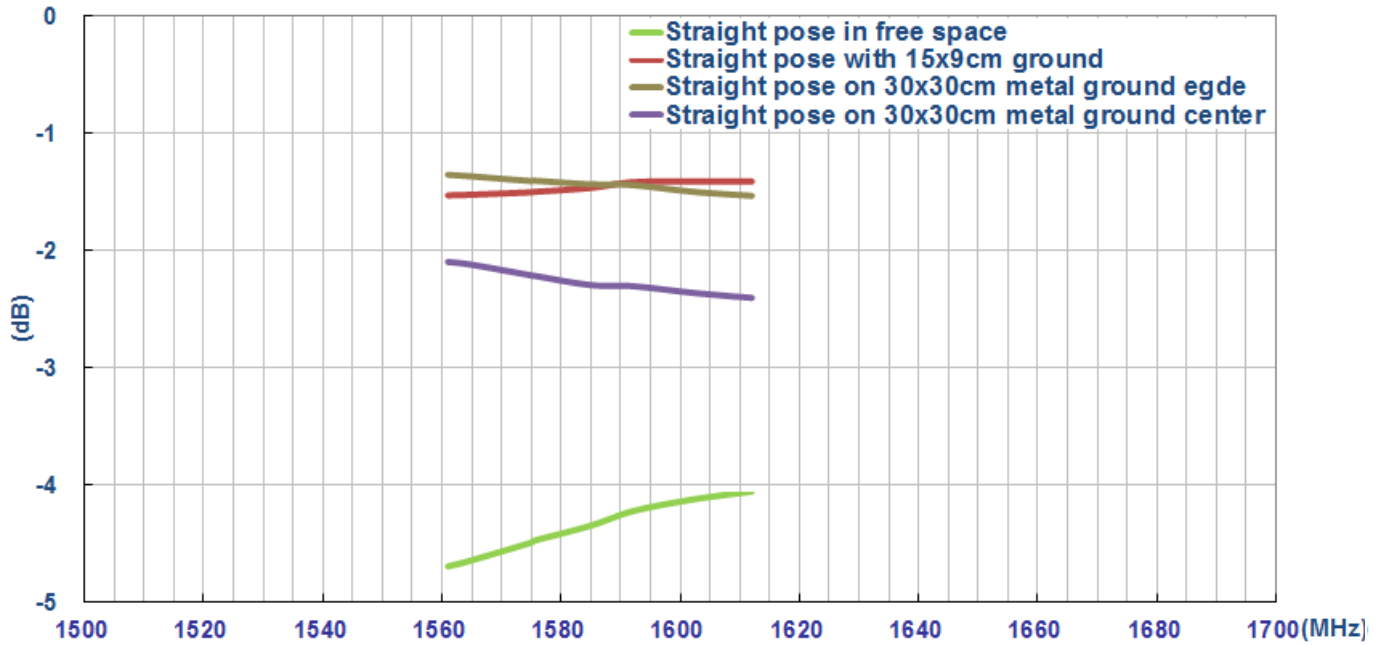

Figure8. Average gain of TS.07 with antenna straight Position

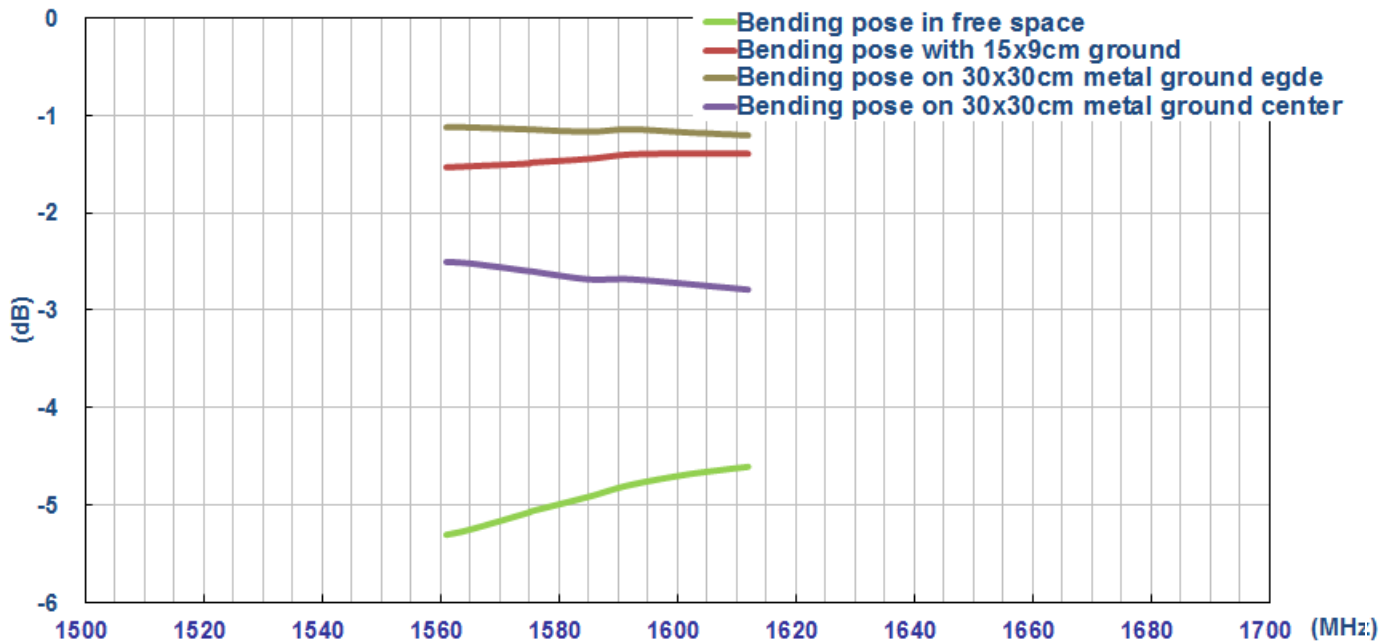
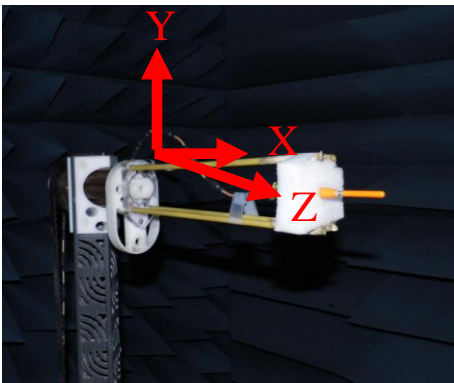

Figure9. Average gain of TS.07 antenna with bent Position

4. Antenna Radiation Patterns

The antenna radiation patterns were measured in a CTIA certified ETS Anechoic Chamber. The measurement setups are shown below.

Antenna with Straight Position



In free space

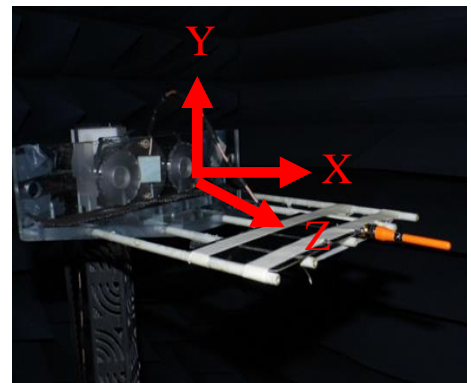

On 15x9cm ground plane

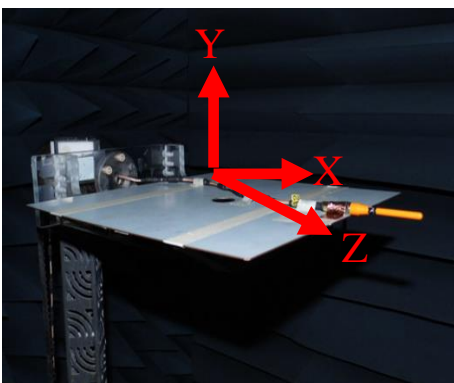

On 30x30cm metal ground center

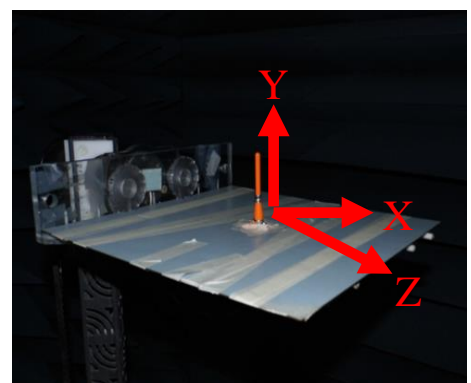

On 30x30cm metal ground edge

Antenna Bent Position

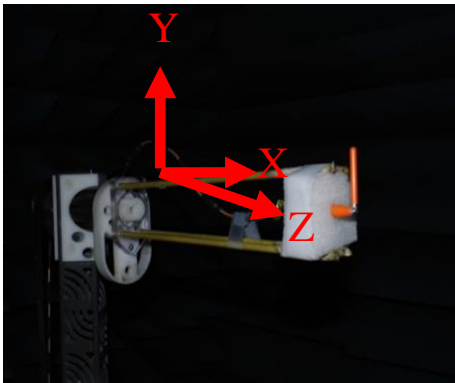

In free space

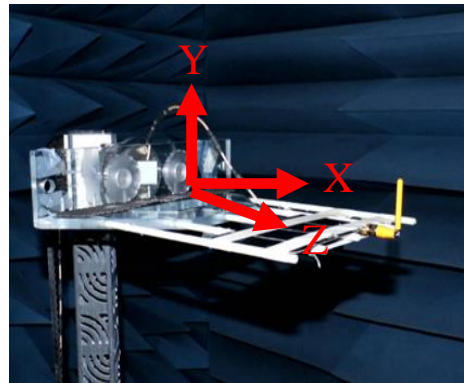

On 15x9cm ground plane

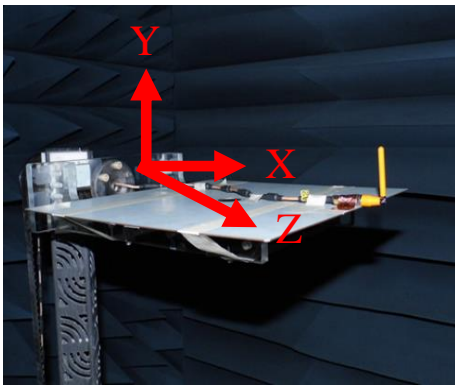

On 30x30cm metal ground center

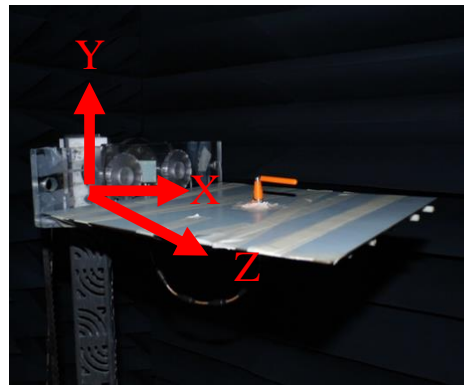

On 30x30cm metal ground edge

Figure.10. Testing Setup in ETS Anechoic Chamber

4.1 2D Radiation pattern (Straight Position in free space)

XY Plane

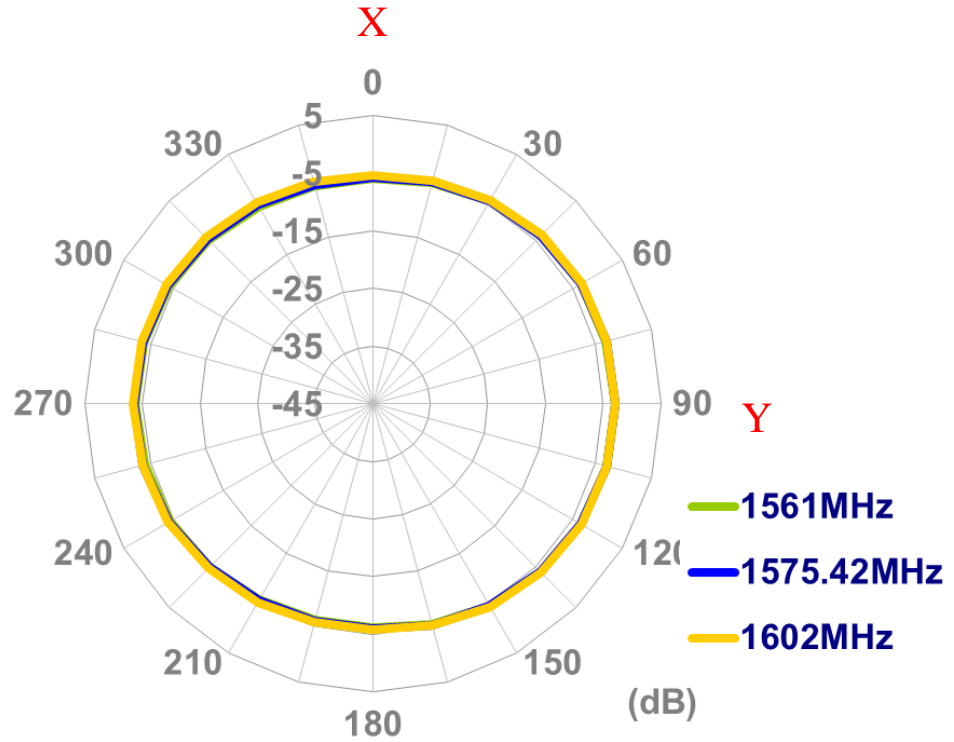

XZ Plane

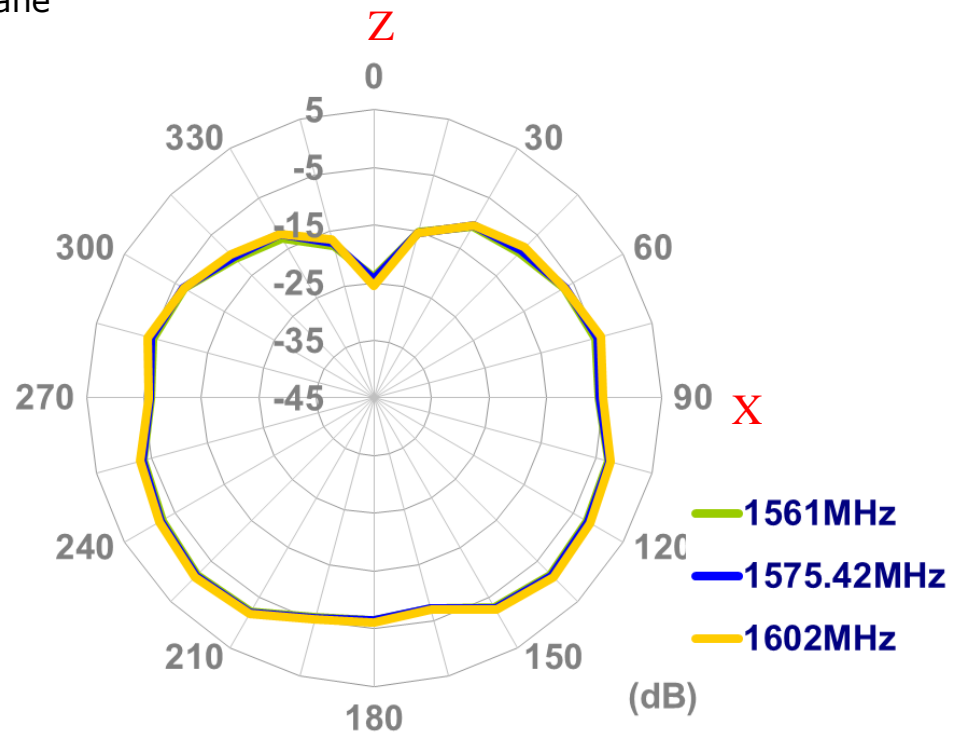

YZ Plane

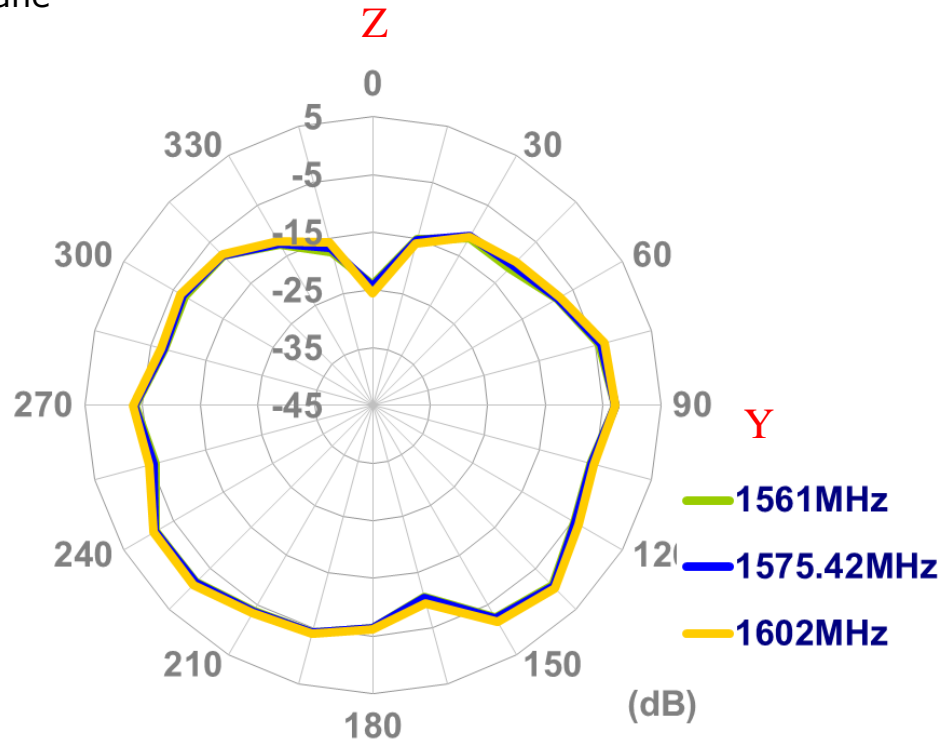

4.2 2D Radiation pattern (Straight Position with 15x9cm ground plane)

XY Plane

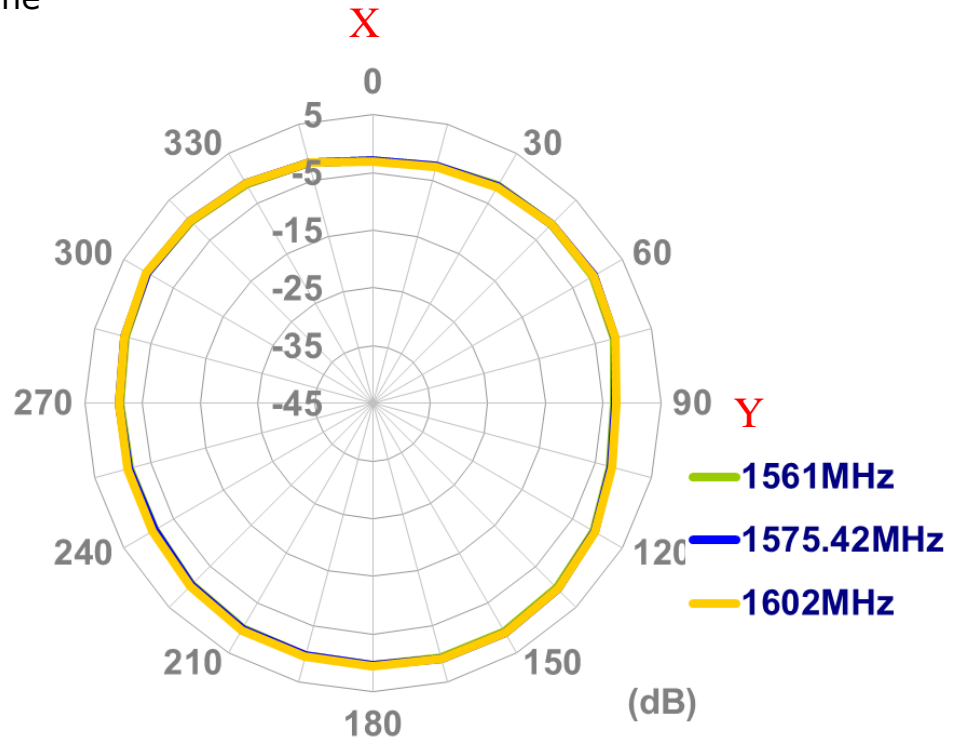

XZ Plane

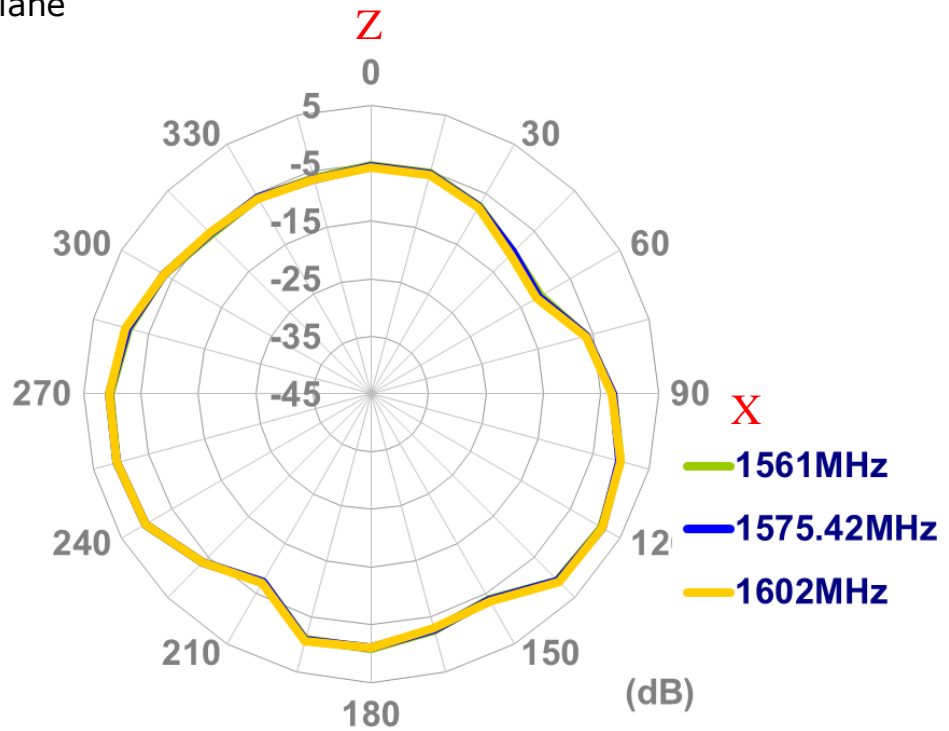

YZ Plane

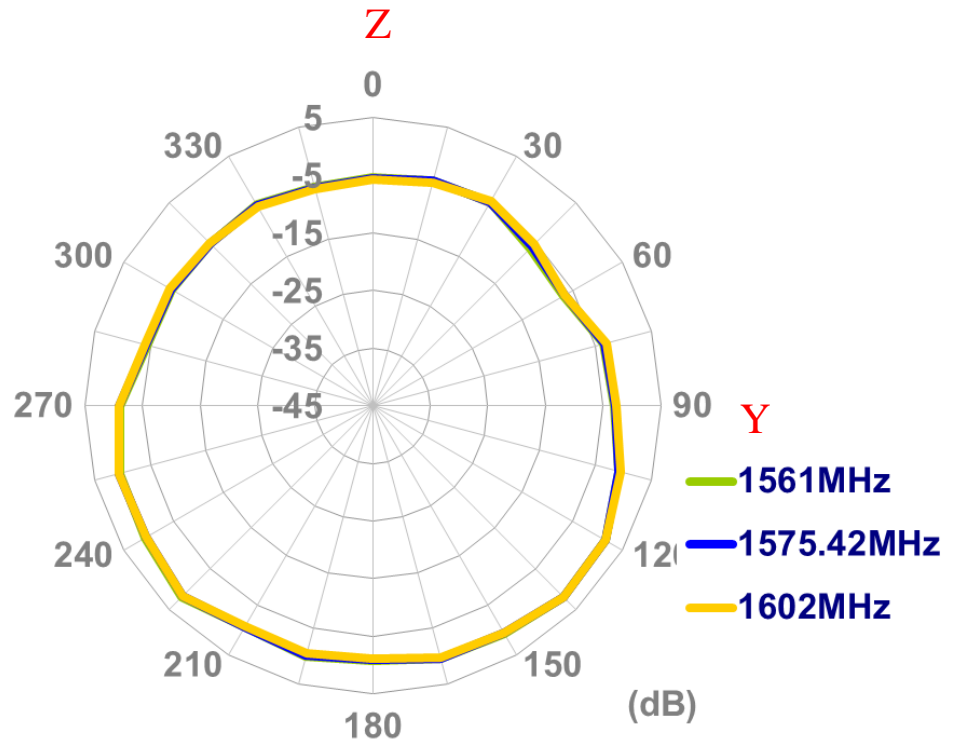

4.3 2D Radiation pattern (Straight Position with 30x30cm ground plane edge)

XY Plane

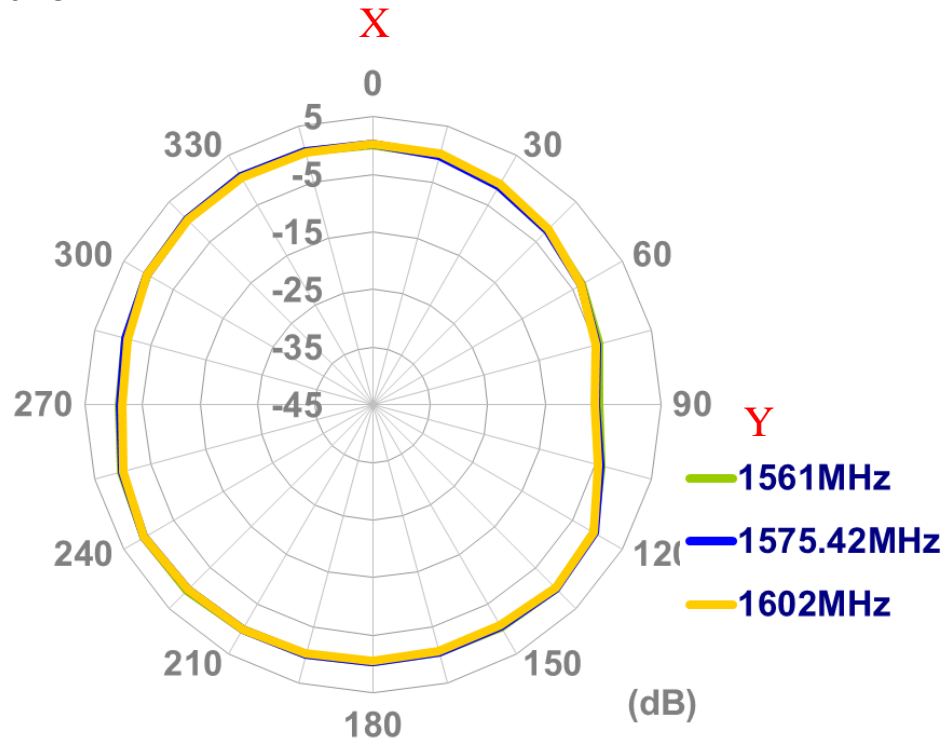

XZ Plane

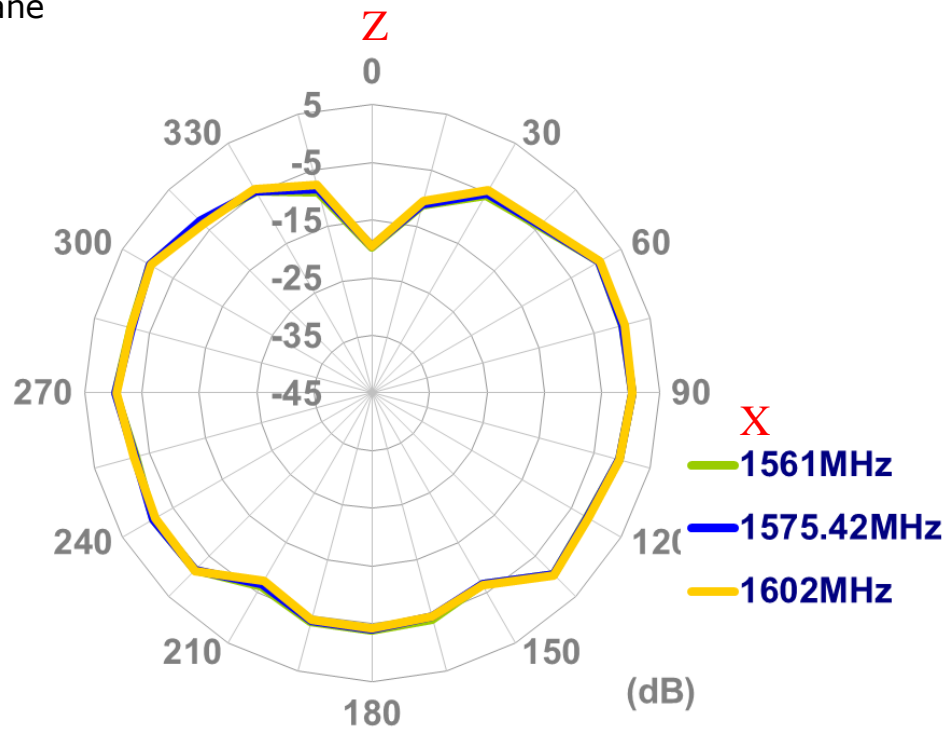

YZ Plane

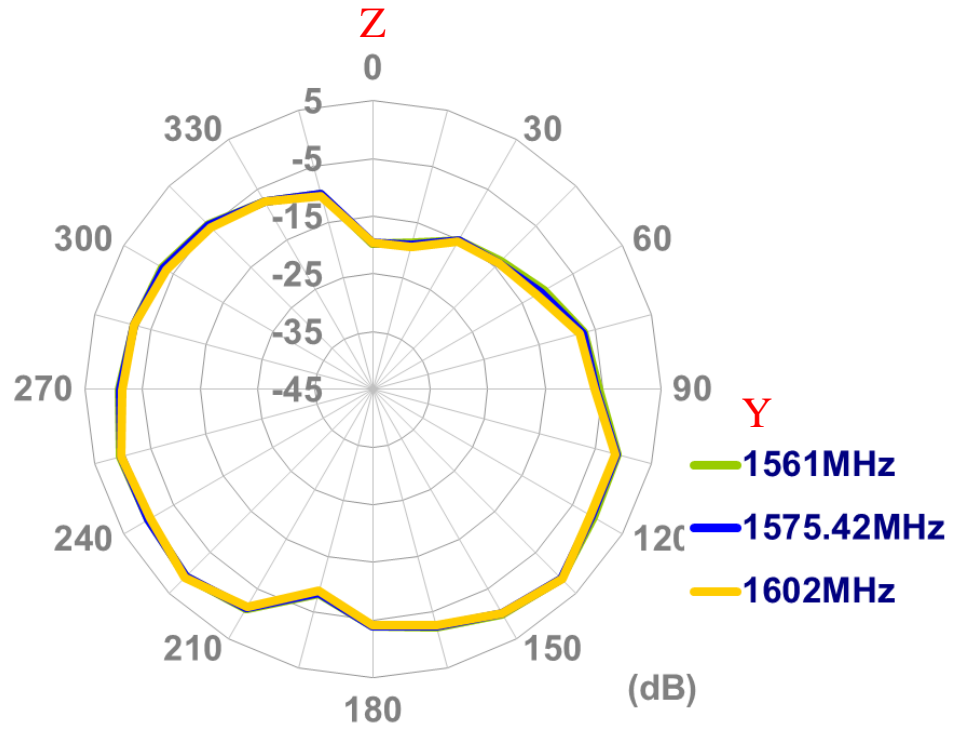

4.4 2D Radiation pattern (Straight Position with 30x30cm ground plane center)

XY Plane

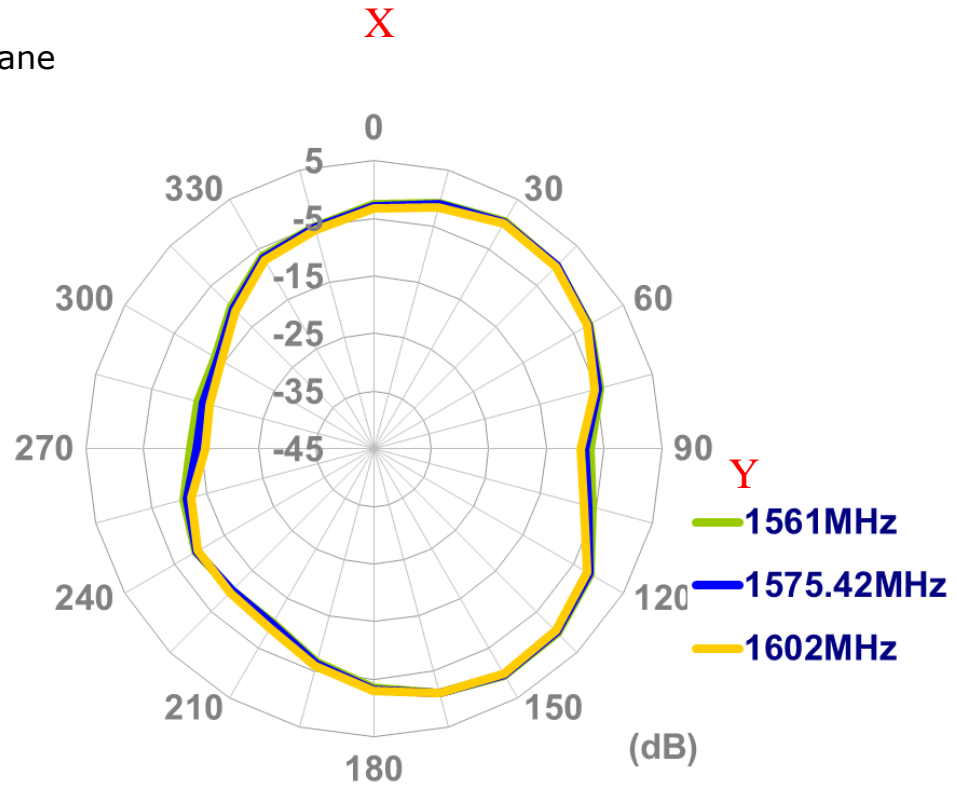

XZ Plane

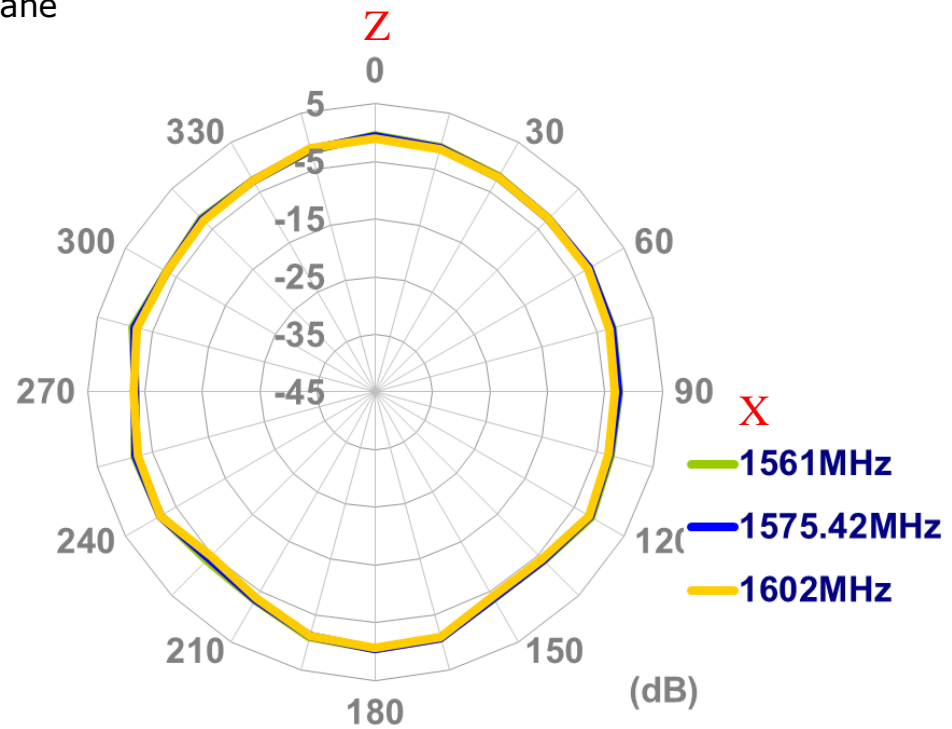

YZ Plane

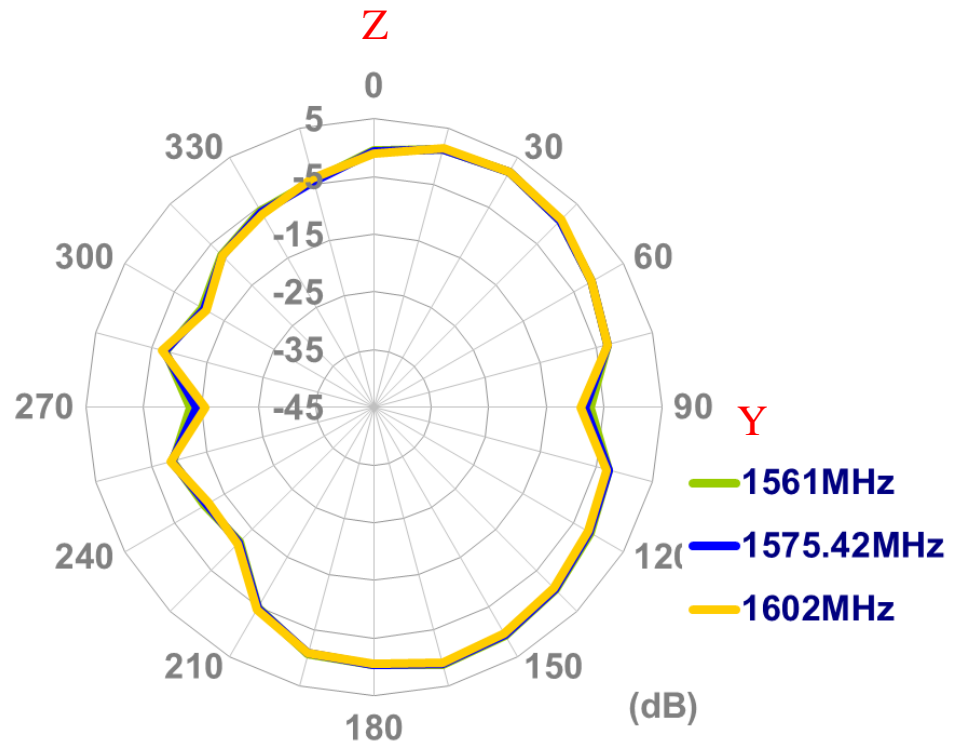

4.5 2D Radiation pattern (Bent Position in free space)

XY Plane

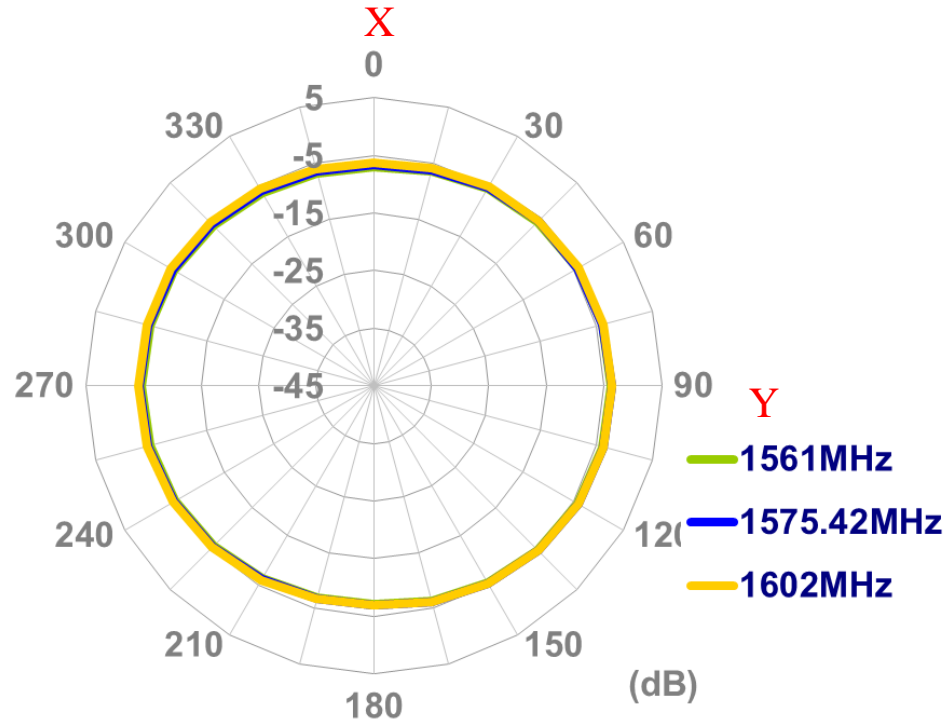

XZ Plane

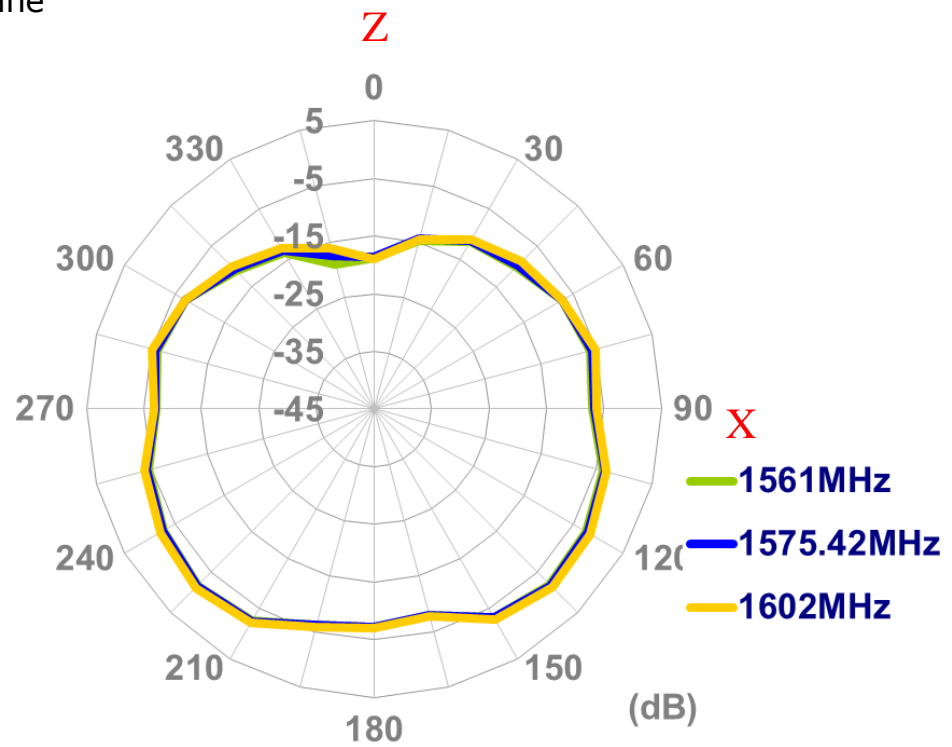

YZ Plane

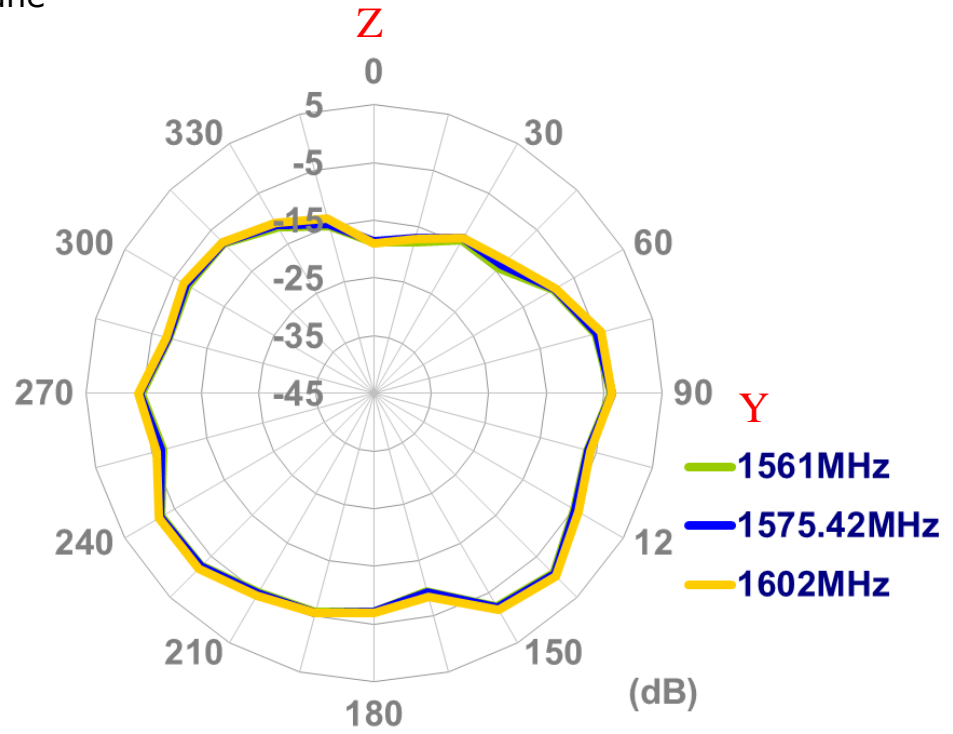

4.6 2D Radiation pattern (Bent Position with 15x9cm ground plane)

XY Plane

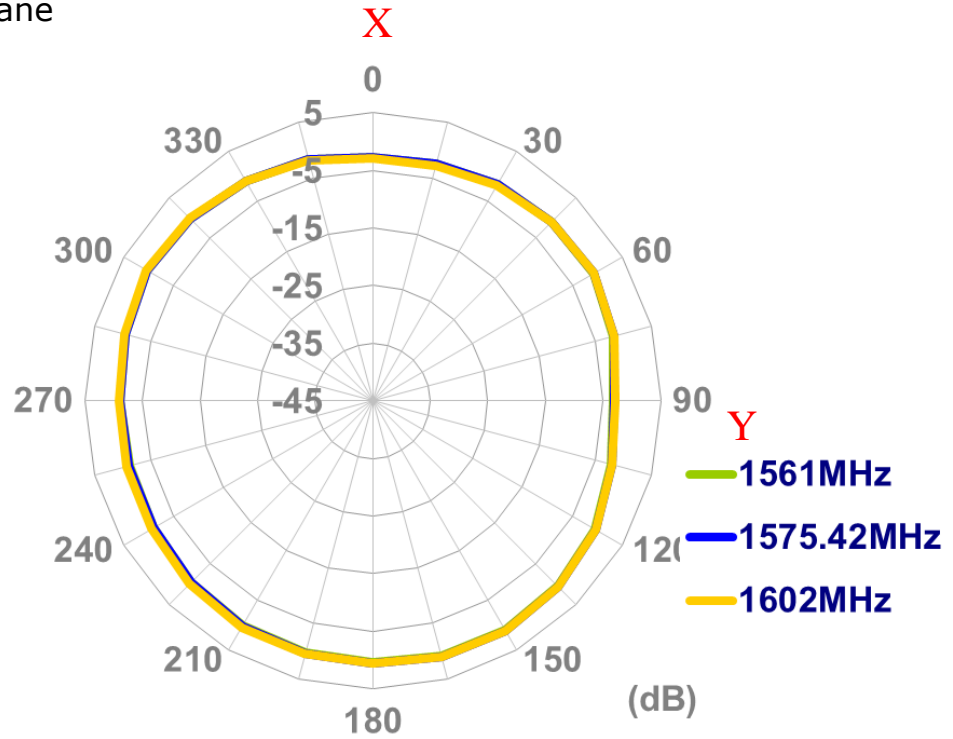

XZ Plane

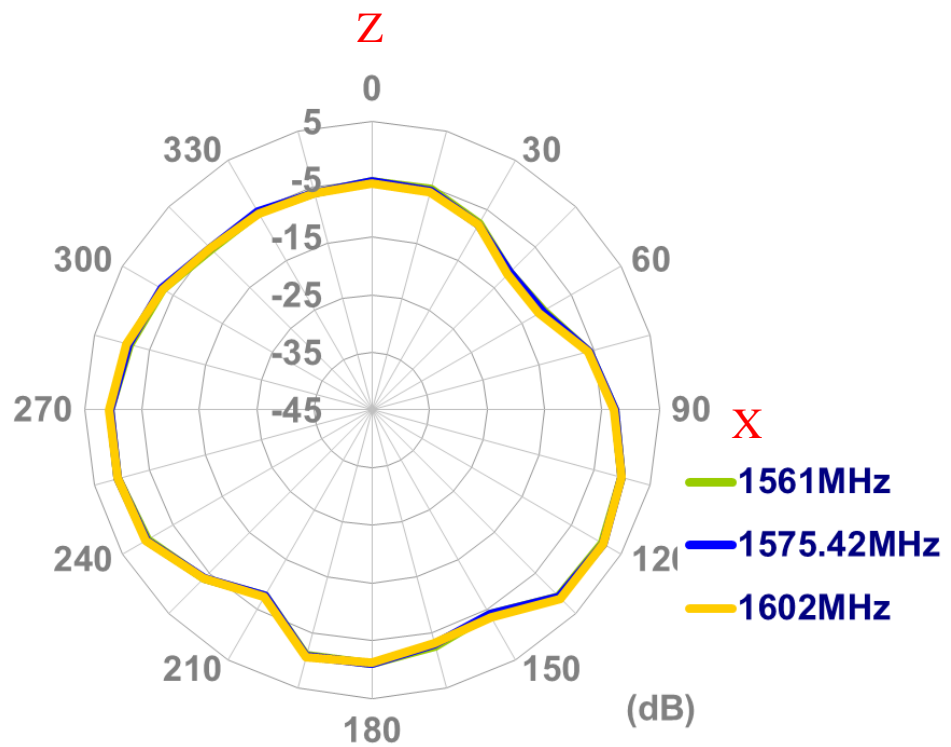

YZ Plane

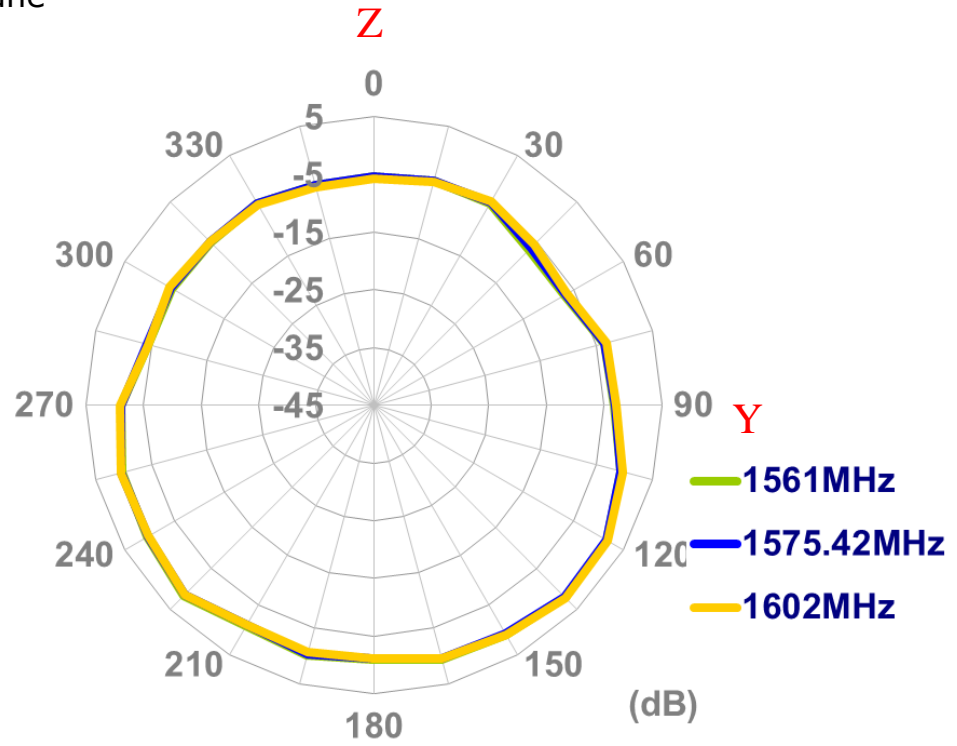

4.7 2D Radiation pattern (Bent Position with 30x30cm ground plane edge)

XY Plane

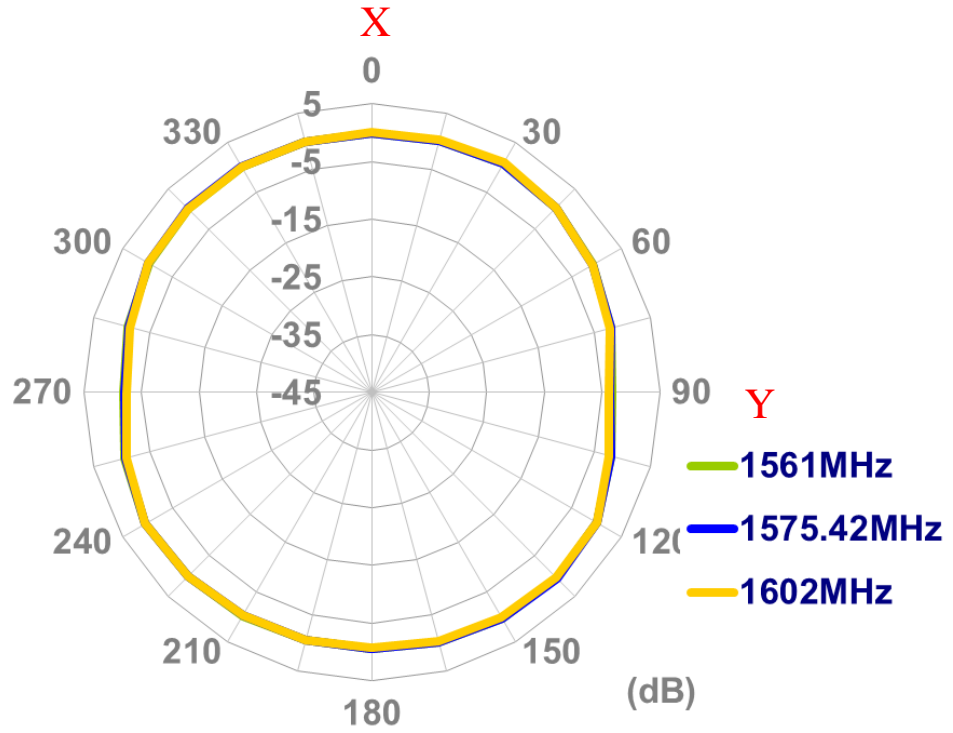

XZ Plane

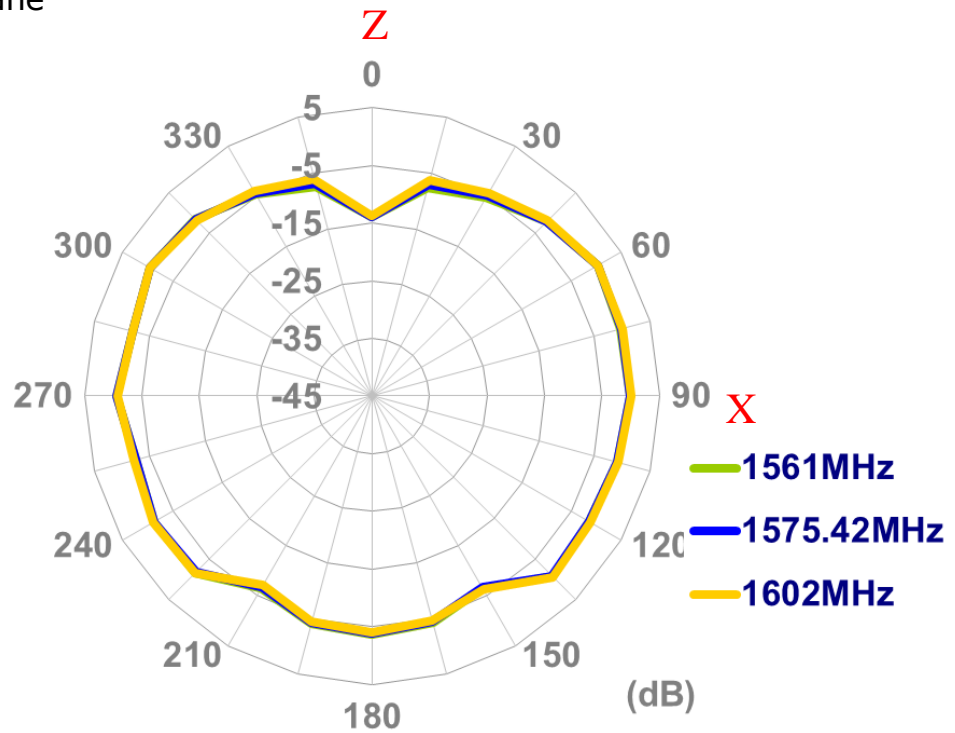

YZ Plane

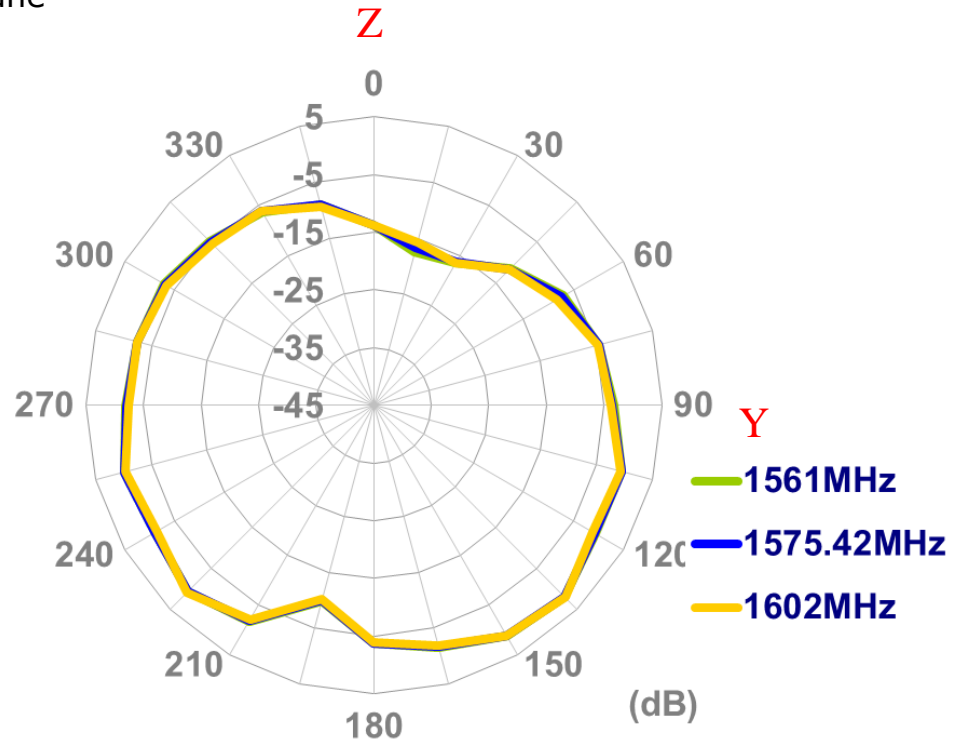

4.8 2D Radiation pattern (Bent Position with 30*30cm ground plane_center)

XY Plane

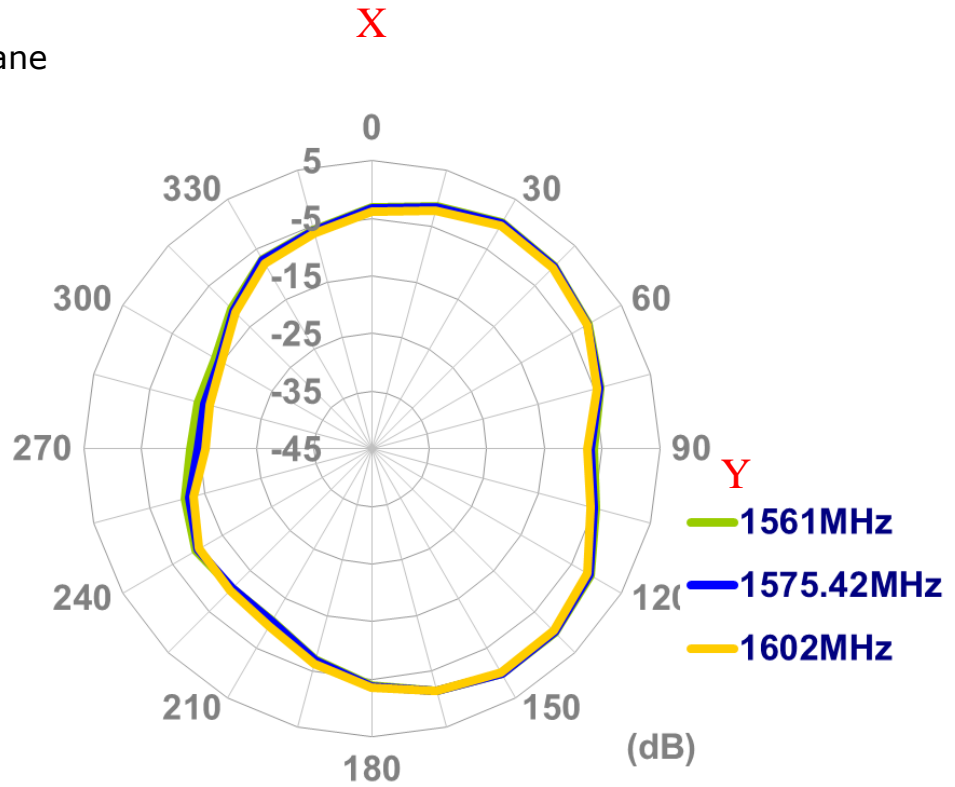

XZ Plane

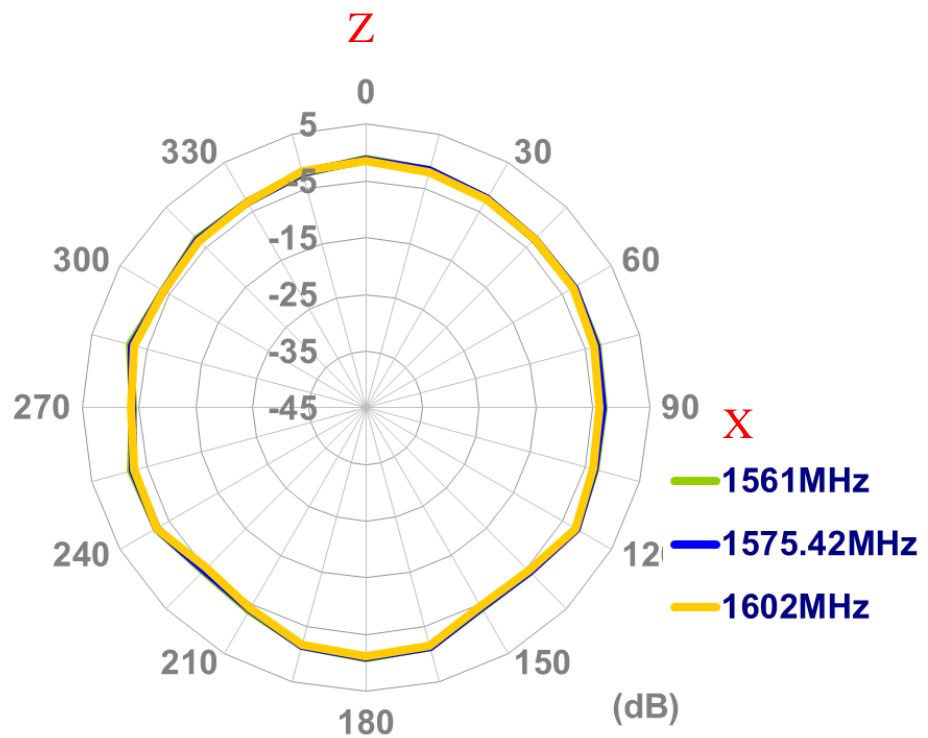

YZ Plane

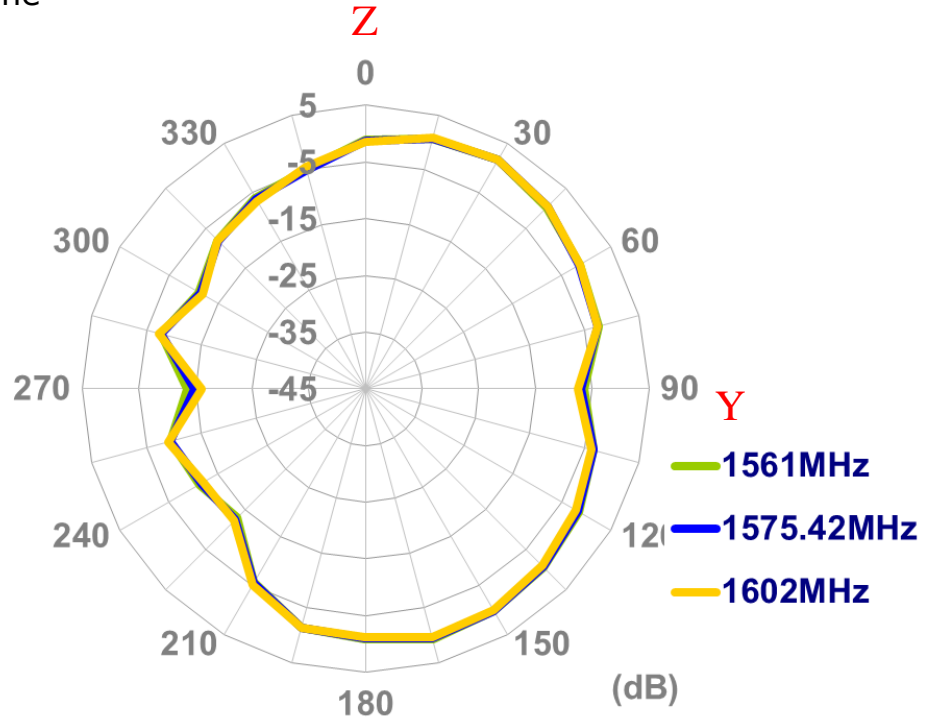

5. Installation

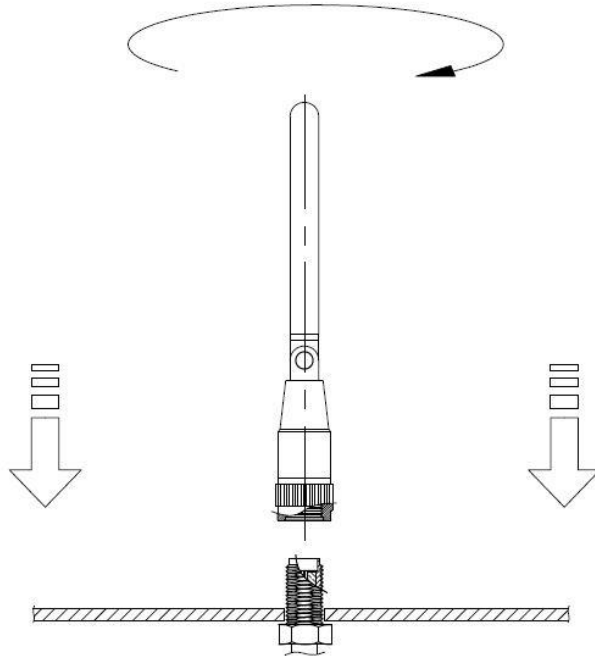

Recommended torque for mounting is 0.9 N.m
Maximum torque for mounting is 1.176 N.m

6. Drawing

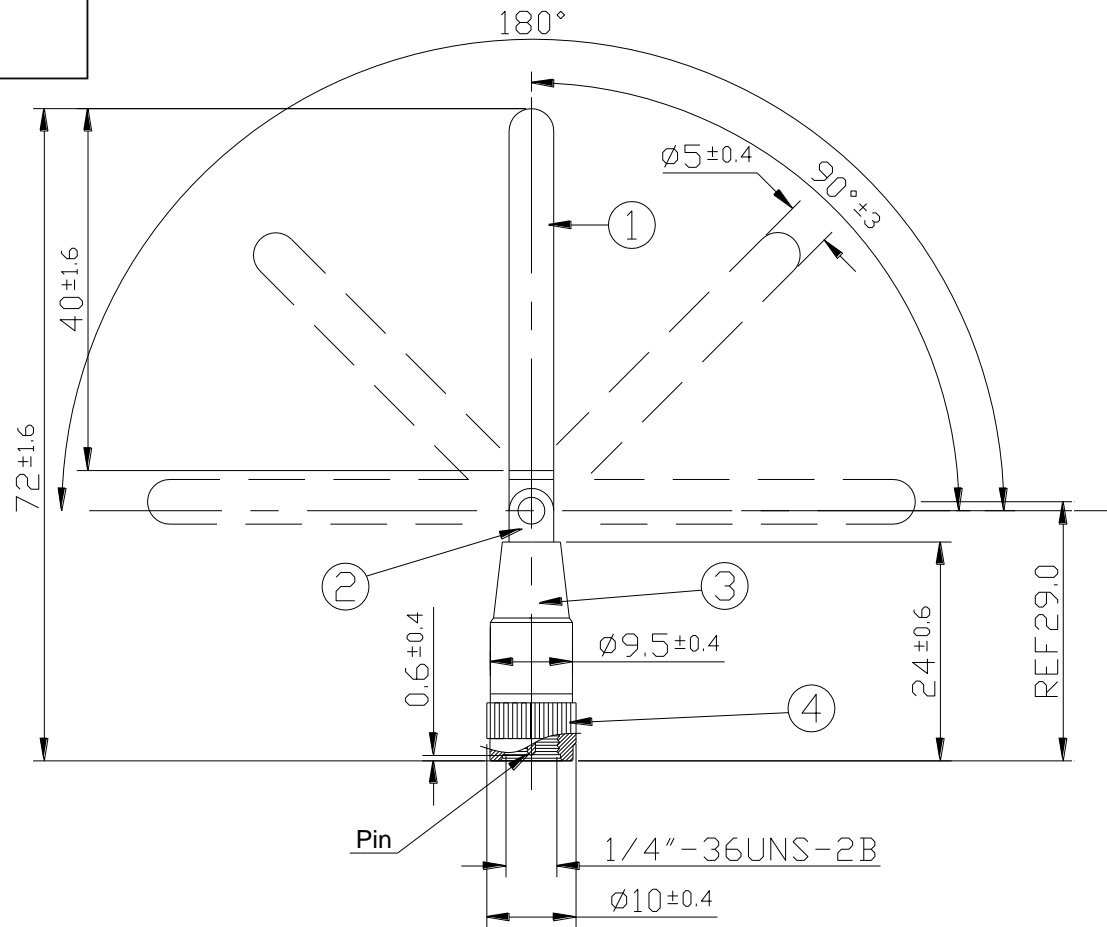
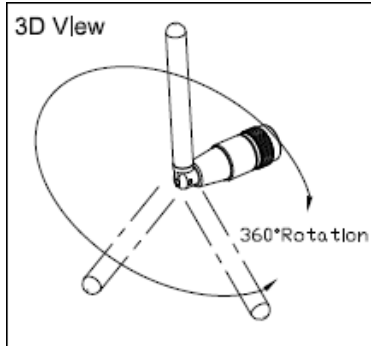

	Name	Material	Finish	QTY
1	Housing	POM	Orange	1
2	Hinge	Brass	Ni Plated	1
3	Cap	POM	Orange	1
4	SMA(M) ST	Brass	Ni Plated	1

7. Packaging

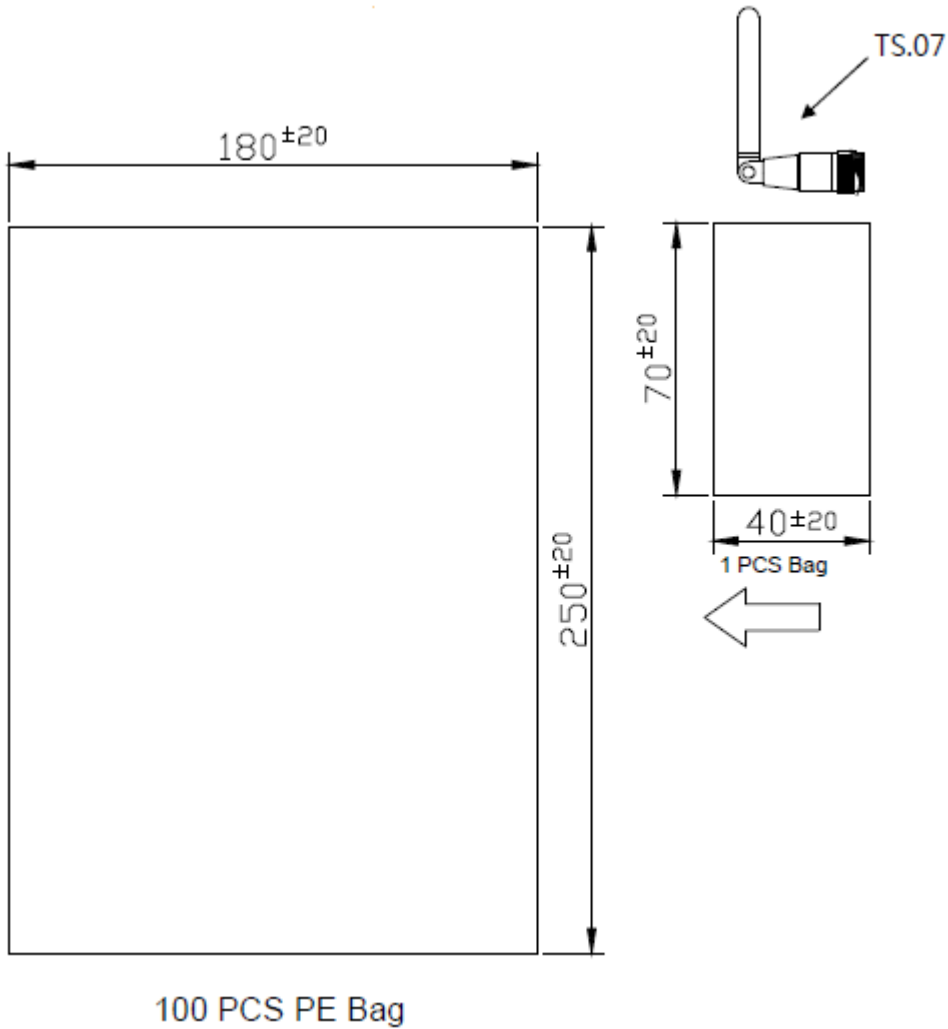

Taoglas makes no warranties based on the accuracy or completeness of the contents of this document and reserves the right to make changes to specifications and product descriptions at any time without notice. Taoglas reserves all rights to this document and the information contained herein.

Reproduction, use or disclosure to third parties without express permission is strictly prohibited.

Copyright © Taoglas Ltd.