

# 9155 MOBO® 3.0mm Pitch Right Angle Battery Connectors

## GENERAL DESCRIPTION

A further addition to the battery connector range offered by AVX is a 90 degree version. On a 3mm pitch, offered in 2 to 5 contact positions and rated as with all of the battery range at 3 amps. The connector's design is small and compact to minimize its profile yet stable while having a contact point 4.61mm above the PCB.

The stability comes from the addition of extra SMT anchor brackets that are in between the SMT contact pads and both at the front of the connector and within the row of the contact SMT pads.

As with the other 9155 series of battery connectors offered by AVX the 90 degree version is rated at 3 amps and 5000 mating cycles, RoHS compliant and using high temperature plastic enables the connectors to be processed at up to 260°C.



## APPLICATIONS

- Mobile phones
- Digital music players
- Hand held terminals
- Data terminals or any other small portable device

## FEATURES AND BENEFITS

- Simple designed spring contact
- End to end stackable for larger pin counts
- Additional contact anchor brackets to added stability on the PCB
- Robust to shock and vibration
- Selectively plated contact area



## HOW TO ORDER

<b>00</b>	<b>9155</b>	<b>002</b>	<b>301</b>	<b>XXX</b>
<b>Prefix</b>	<b>Series</b>	<b>No. of Ways</b>	<b>Right Angle Battery Connector</b>	<b>Plating Option</b>

Code	No. of Ways
002	2
003	3
004	4
005	5

Code	Description
301	Right Angle 3.00mm Battery Connector

Code	Description
006	0.4µm Selective Gold, Pure Tin Tail
008	0.8µm Selective Gold, Pure Tin Tail

# 9155 MOBO<sup>®</sup> 3.0mm Pitch Right Angle Battery Connectors



## 2 Way Right Angle Battery Connector

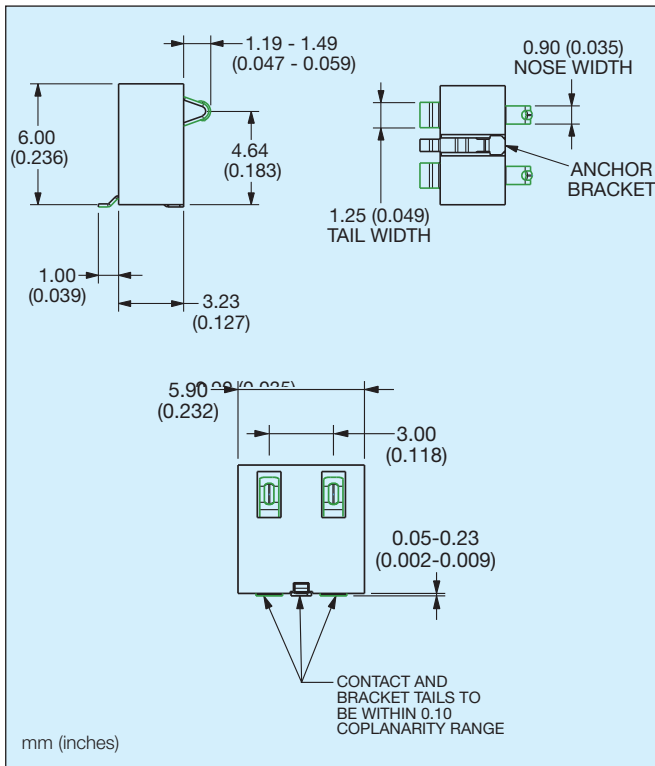

## 3 Way Right Angle Battery Connector

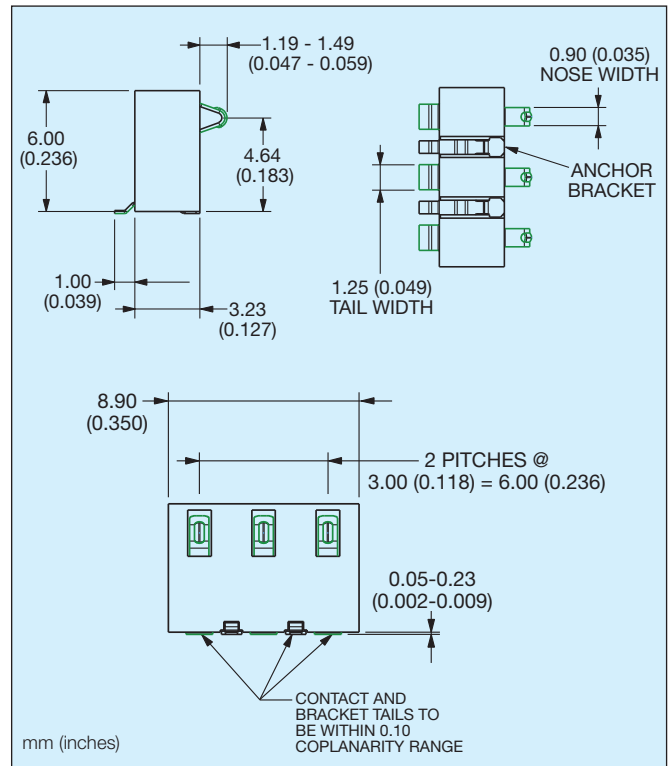

## 4 Way Right Angle Battery Connector

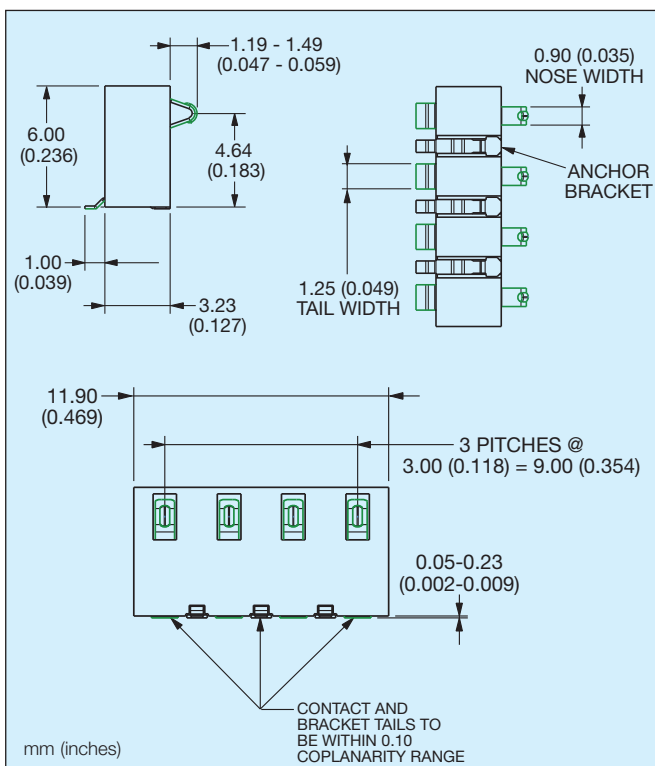

## 5 Way Right Angle Battery Connector

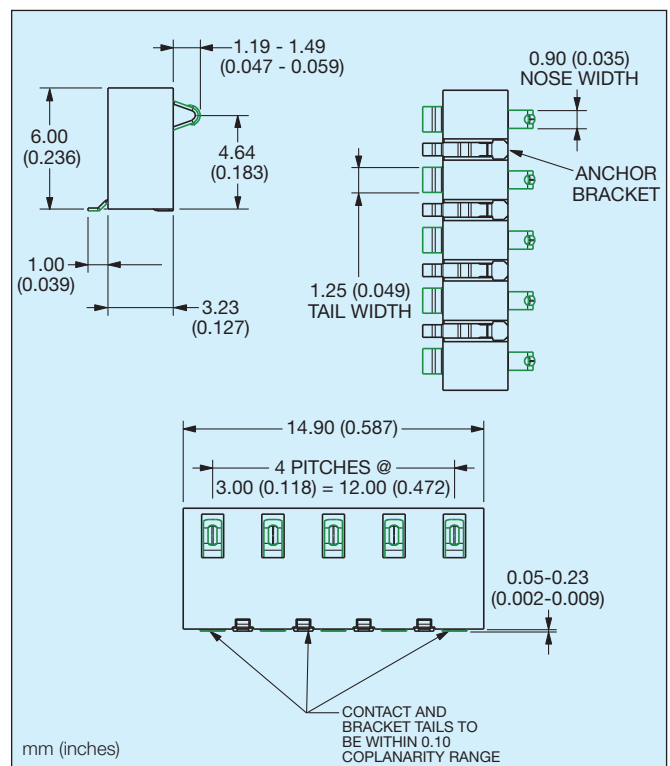

# 9155 MOBO® 3.0mm Pitch Right Angle Battery Connectors



## 2 Way Right Angle Battery Connector PCB Layout

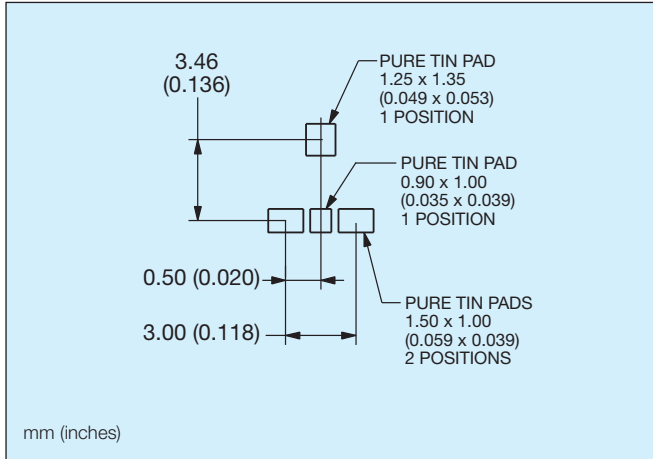

## 3 Way Right Angle Battery Connector PCB Layout

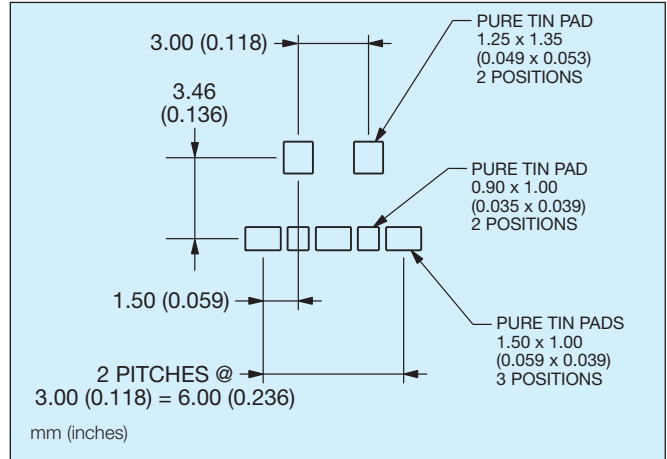

## 4 Way Right Angle Battery Connector PCB Layout

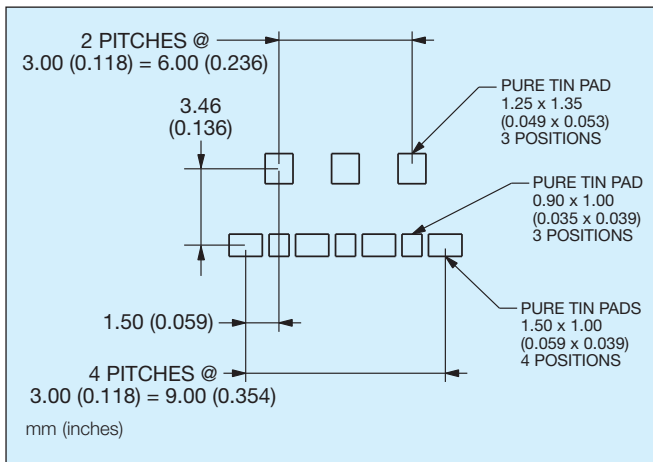

## 5 Way Right Angle Battery Connector PCB Layout

