

Description

The DGD0215 and DGD0216 high speed / low side MOSFET and IGBT drivers are capable of driving 1.9A of peak current. The DGD0215 and DGD0216 logic inputs are compatible with standard TTL and CMOS levels (down to 3.3V) to interface easily with MCUs. Internal undervoltage lockout (UVLO) will protect MOSFETs with loss of supply by turning off the output when Vcc falls below the operating range. Fast and well matched propagation delays allow high speed operation, enabling a smaller and more compact power switching design using smaller associated components.

The DGD0215 and DGD0216 are highly resistant to noise, and are able to withstand up to 5V positive or negative on the ground pin without damage. The devices can also withstand 500mA of reverse current forced back into the outputs without damage or logic change. The DGD0215 provides an inverted output and the DGD0216 provides a non-inverting output.

The DGD0215 and DGD0216 are offered in TSOT25 (Type TH) package and the operating temperature extends from -40°C to +125°C.

Applications

- DC-DC Converters
- Line Drivers
- Motor Controls
- Switch Mode Power Supplies

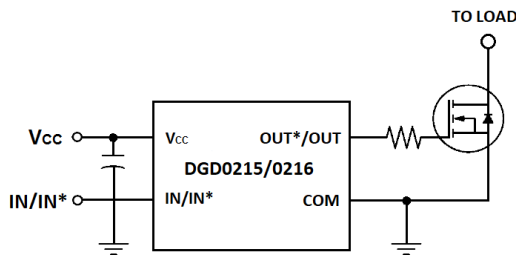

Typical Configuration



TSOT25 (Type TH)

Features

- Efficient Low Cost Solution for Driving MOSFETs and IGBTs
- Wide Supply Voltage Operating Range: 4.5V to 18V
- 1.9A Source / 1.8A Sink Output Current Capability
- Inverting and Non-Inverting Input Configurations
- Undervoltage Lockout for Vcc Supply
- Fast Propagation Delay (35ns Typ.)
- Fast Rise and Fall Times (15ns Typ.)
- Logic Input (IN) 3.3V Capability
- Extended Temperature Range: -40°C to +125°C
- **Totally Lead-Free & Fully RoHS Compliant (Notes 1 & 2)**
- **Halogen and Antimony Free. "Green" Device (Note 3)**

Mechanical Data

- Case: TSOT25
- Case Material: Molded Plastic. "Green" Molding Compound.
- UL Flammability Classification Rating 94V-0
- Moisture Sensitivity: Level 3 per J-STD-020
- Terminals: Finish – Matte Tin Plated Leads. Solderable per MIL-STD-202, Method 208 Ⓔ3
- Weight: 0.012 grams (Approximate)

Ordering Information (Note 4)

Part number	Marking	Reel Size (inches)	Tape Width (mm)	Quantity per Reel
DGD0215WT-7	D0215	7	8	3,000
DGD0216WT-7	D0216	7	8	3,000

- Notes:
1. No purposely added lead. Fully EU Directive 2002/95/EC (RoHS), 2011/65/EU (RoHS 2) & 2015/863/EU (RoHS 3) compliant.
 2. See <https://www.diodes.com/quality/lead-free/> for more information about Diodes Incorporated's definitions of Halogen- and Antimony-free, "Green" and Lead-free.
 3. Halogen- and Antimony-free "Green" products are defined as those which contain <900ppm bromine, <900ppm chlorine (<1500ppm total Br + Cl) and <1000ppm antimony compounds.
 4. For packaging details, go to our website at <https://www.diodes.com/design/support/packaging/diodes-packaging/>.

Marking Information

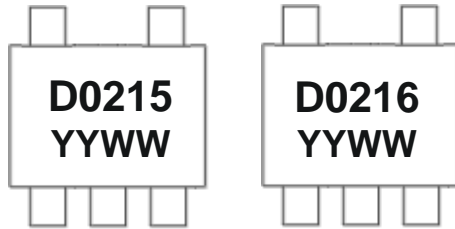

D021x = Product Type Marking Code
 YY = Year (ex: 19 = 2019)
 WW = Week (01 to 53)

Pin Diagrams

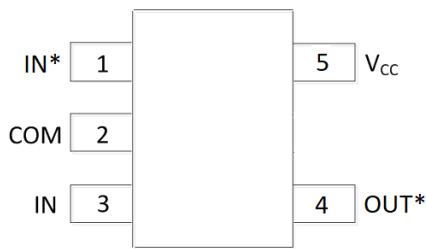

DGD0215

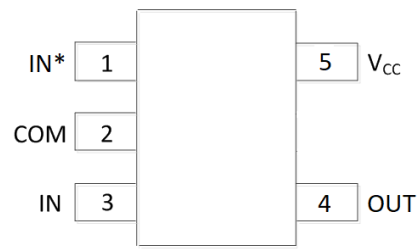

DGD0216

Top View: TSOT25 (Type TH)

Pin Descriptions

Pin Number	Pin Name	Function
1	IN*	Logic Input, In Phase with OUT* (DGD0215), Out of Phase with OUT (DGD0216), leave open when not in use.
2	COM	Supply Return
3	IN	Logic Input, Out of Phase with OUT* (DGD0215), In Phase with OUT (DGD0216), leave open when not in use.
4	OUT*/OUT	Gate Drive Output
5	Vcc	Supply Input

Functional Block Diagram

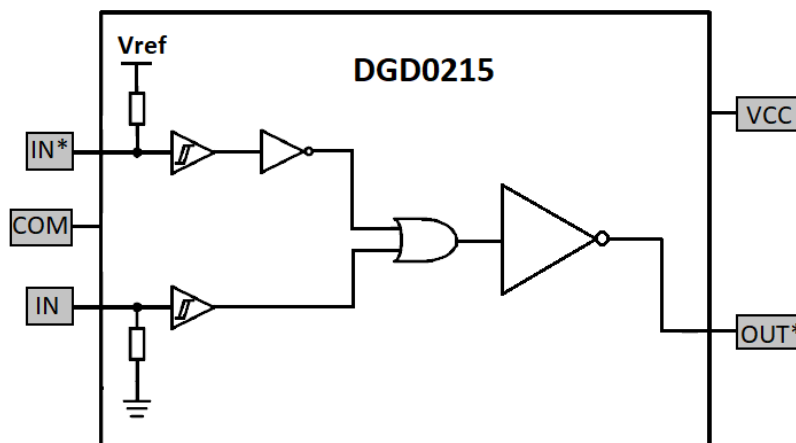

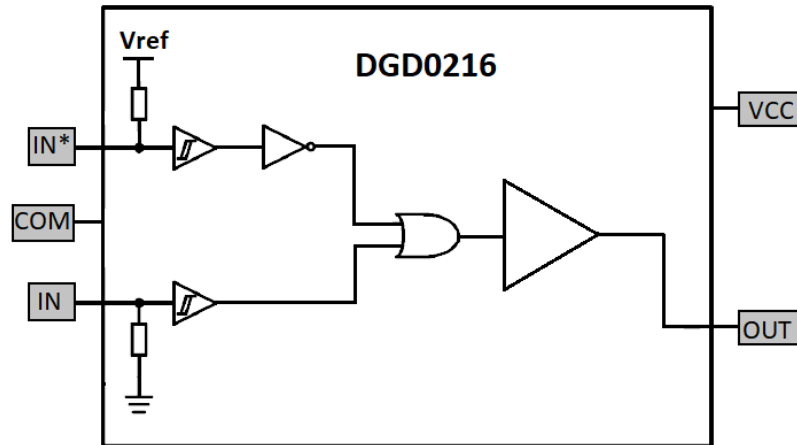
Functional Block Diagram (Cont.)

Absolute Maximum Ratings (@ $T_A = +25^\circ\text{C}$, unless otherwise specified.)

Characteristic	Symbol	Value	Unit
Low-side Fixed Supply Voltage	V_{CC}	-0.3 to +22	V
Output Voltage (OUT/OUT*)	V_{OUT}	-0.3 to $V_{CC}+0.3$	V
Logic Input Voltage (IN)	V_{IN}	-5 to $V_{CC}+0.3$	V

Thermal Characteristics (@ $T_A = +25^\circ\text{C}$, unless otherwise specified.)

Characteristic	Symbol	Value	Unit
Power Dissipation Linear Derating Factor (Note 5)	P_D	0.54	W
Thermal Resistance, Junction to Ambient (Note 5)	$R_{\theta JA}$	188	$^\circ\text{C}/\text{W}$
Operating Temperature	T_J	+150	$^\circ\text{C}$
Lead Temperature (Soldering, 10s)	T_L	+300	
Storage Temperature Range	T_{STG}	-55 to +150	

Note: 5. When mounted on a standard JEDEC 2-layer FR-4 board.

ESD Ratings (Note 6)

Characteristic	Symbol	Value	Unit	JEDEC Class
Electrostatic Discharge - Human Body Model	ESD HBM	2,000	V	2

Note: 6. Refer to JEDEC specification JESD22-A114.

Recommended Operating Conditions

Parameter	Symbol	Min	Max	Unit
Supply Voltage	V_B	4.5	18	V
Output Voltage (OUT/OUT*)	V_S	0	V_{CC}	V
Logic Input Voltage (IN)	V_{IN}	0	5	V
Ambient Temperature	T_A	-40	+125	$^\circ\text{C}$

DC Electrical Characteristics (V_{BIAS} (4.5V < V_{CC} < 18V), @ T_A = +25°C, unless otherwise specified.) (Note 7)

Parameter	Symbol	Min	Typ	Max	Unit	Conditions
Logic "1" Input Voltage	V_{IH}	2.4	1.6	–	V	–
Logic "0" Input Voltage	V_{IL}	–	1.3	0.8	V	–
Logic "1" Input Bias Current	I_{IN+}	–	–	5	μ A	$V_{IN} = 3V, V_{IN^*} = 0V$
Logic "0" Input Bias Current	I_{IN-}	–	–	2	μ A	$V_{IN} = 0V, V_{IN^*} = 3V$
High Level Output Voltage, $V_{BIAS} - V_O$	V_{OH}	–	25	–	mV	–
Low Level Output Voltage	V_{OL}	–	25	–	mV	–
Quiescent V_{CC} Supply Current	I_{CCQ}	–	50	100	μ A	$V_{IN} = 0V$ or 3V
Output High Short Circuit Pulsed Current	I_{O+}	–	1.9	–	A	$V_{CC} = 12V$
Output Low Short Circuit Pulsed Current	I_{O-}	–	1.8	–	A	$V_{CC} = 12V$
Output Resistance, High	R_{OH}	–	3.3	–	Ω	$I_{OUT} = 10mA, V_{CC} = 12V$
Output Resistance, Low	R_{OL}	–	2.3	–	Ω	$I_{OUT} = 10mA, V_{CC} = 12V$

Note: 7. The V_{IN} and I_{IN} parameters are applicable to the logic input pin: IN. The V_O and I_O parameters are applicable to the output pins: OUT and OUT*.

AC Electrical Characteristics (V_{BIAS} (4.5V < V_{CC} < 18V), @ T_A = +25°C, unless otherwise specified.)

Parameter	Symbol	Min	Typ	Max	Unit	Conditions
Turn-on Rise Time	t_R	–	15	25	ns	$C_L = 1000pF, V_{CC} = 12V$
Turn-off Fall Time	t_F	–	15	25	ns	$C_L = 1000pF, V_{CC} = 12V$
Turn-on Propagation Delay	t_{ON}	–	35	50	ns	$V_{CC} = 12V$
Turn-off Propagation Delay	t_{OFF}	–	35	55	ns	$V_{CC} = 12V$

DC Electrical Characteristics (V_{BIAS} (4.5V < V_{CC} < 18V), @ T_C = -40°C to +125°C, unless otherwise specified.)

Parameter	Symbol	Min	Typ	Max	Unit	Conditions
Logic "1" Input Voltage	V_{IH}	2.4	–	–	V	–
Logic "0" Input Voltage	V_{IL}	–	–	0.8	V	–
Logic "1" Input Bias Current	I_{IN+}	–	–	10	μ A	$V_{IN} = 3V$
Logic "0" Input Bias Current	I_{IN-}	–	0	5	μ A	$V_{IN} = 0V$
High Level Output Voltage, $V_{BIAS} - V_O$	V_{OH}	–	25	–	mV	–
Low Level Output Voltage	V_{OL}	–	25	–	mV	–
Quiescent V_{CC} Supply Current	I_{CCQ}	–	0.1	0.2	mA	$V_{IN} = 0V$ or 3V
Output Resistance, High	R_{OH}	–	–	10	Ω	$I_{OUT} = 10mA$, $V_{CC} = 12V$
Output Resistance, Low	R_{OL}	–	–	7	Ω	$I_{OUT} = 10mA$, $V_{CC} = 12V$

AC Electrical Characteristics (V_{BIAS} (4.5V < V_{CC} < 18V), @ T_C = -40°C to +125°C, unless otherwise specified.)

Parameter	Symbol	Min	Typ	Max	Unit	Conditions
Turn-on Rise Time	t_R	–	30	40	ns	$C_L = 1000pF$, $V_{CC} = 12V$
Turn-off Fall Time	t_F	–	30	40	ns	$C_L = 1000pF$, $V_{CC} = 12V$
Turn-on Propagation Delay	t_{ON}	–	45	55	ns	$V_{CC} = 12V$
Turn-off Propagation Delay	t_{OFF}	–	50	60	ns	$V_{CC} = 12V$

Timing Waveforms

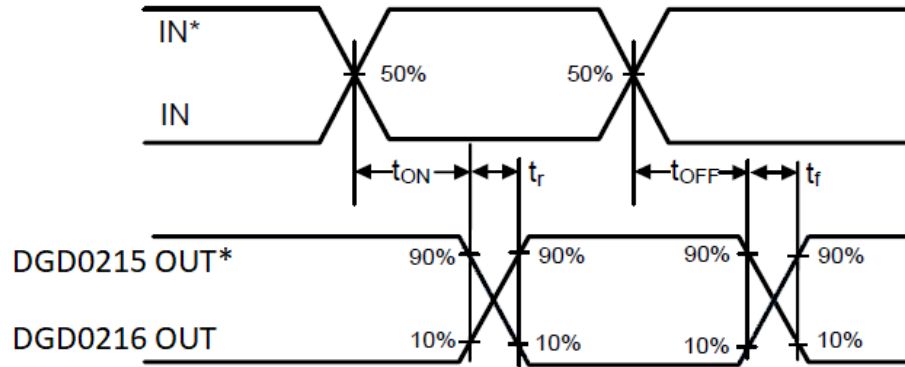

Figure 1. Switching Time Waveform Definitions

Input/Output Response Table

Input pin	Input logic	DGD0215 (OUT*)	DGD0216 (OUT)
IN	H	L	H
IN	L	H	L
IN*	H	H	L
IN*	L	L	H

Typical Performance Characteristics (@ $T_A = +25^\circ\text{C}$, unless otherwise specified.)

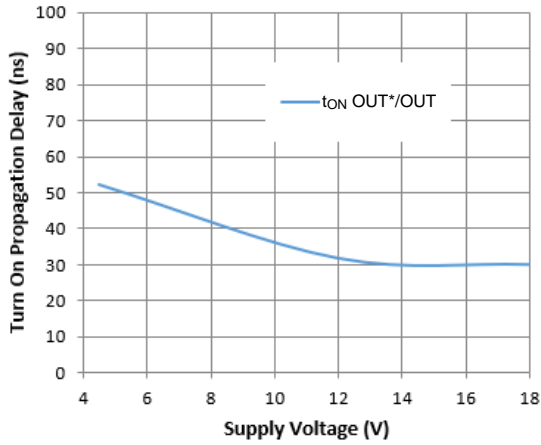

Figure 2. Turn-on Propagation Delay vs. Supply Voltage

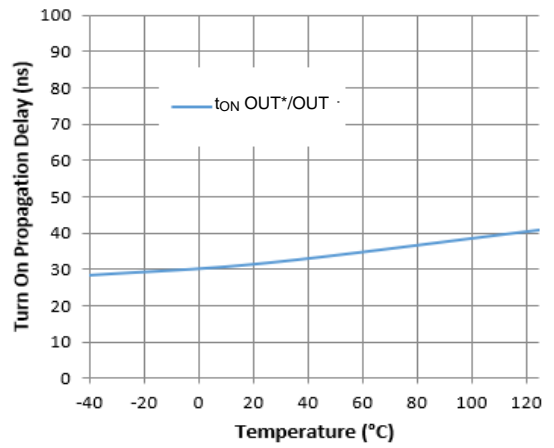

Figure 3. Turn-on Propagation Delay vs. Temperature

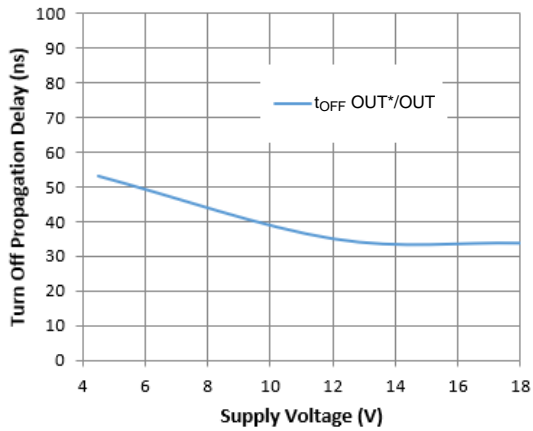

Figure 4. Turn-off Propagation Delay vs. Supply Voltage

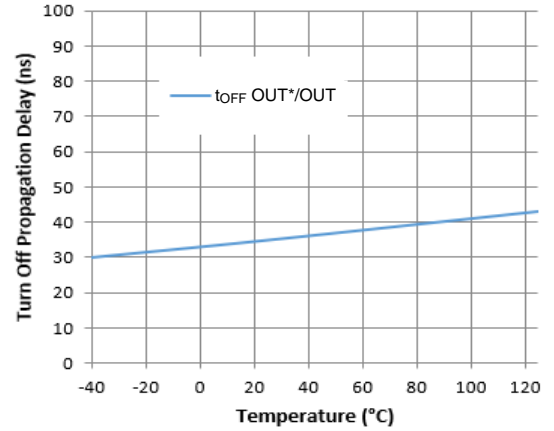

Figure 5. Turn-off Propagation Delay vs. Temperature

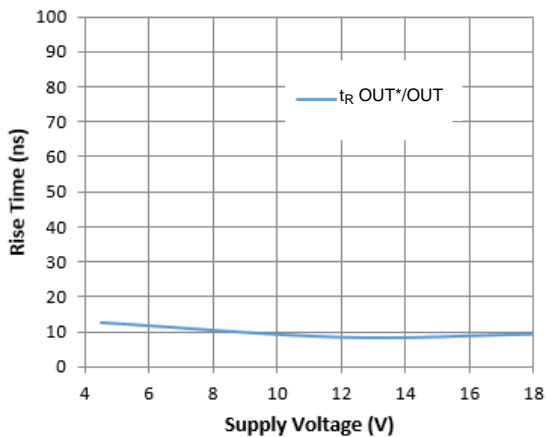

Figure 6. Rise Time vs. Supply Voltage

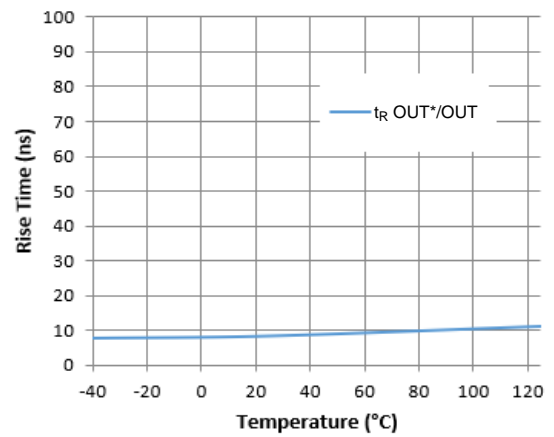

Figure 7. Rise Time vs. Temperature

Typical Performance Characteristics (Cont.)

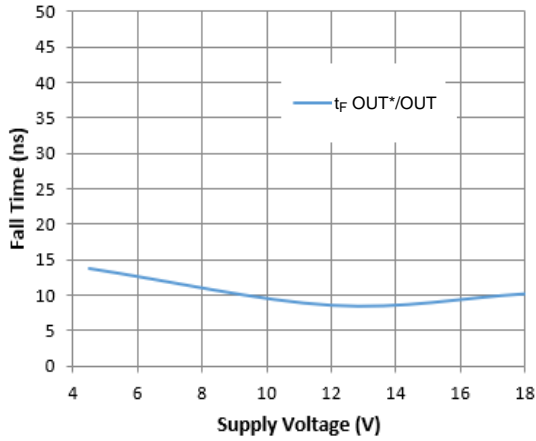

Figure 8. Fall Time vs. Supply Voltage

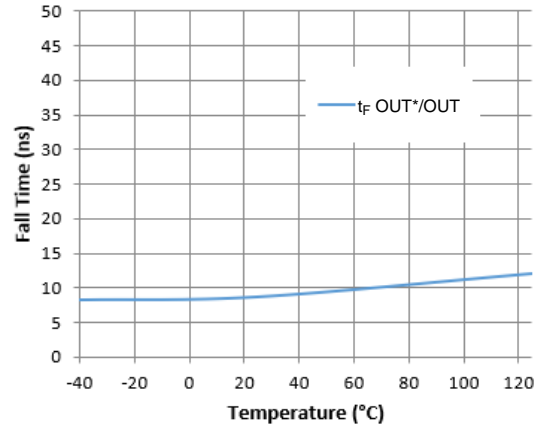

Figure 9. Fall Time vs. Temperature

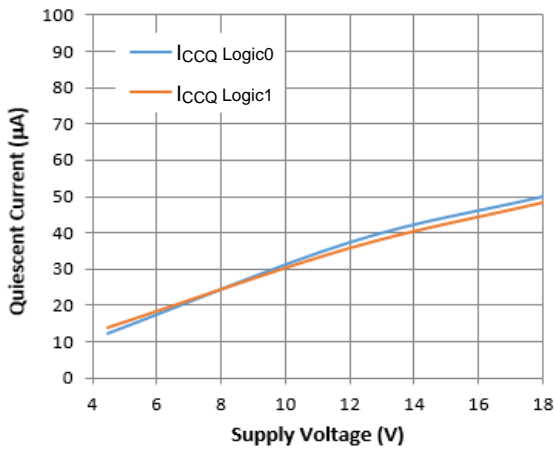

Figure 10. Quiescent Current vs. Supply Voltage

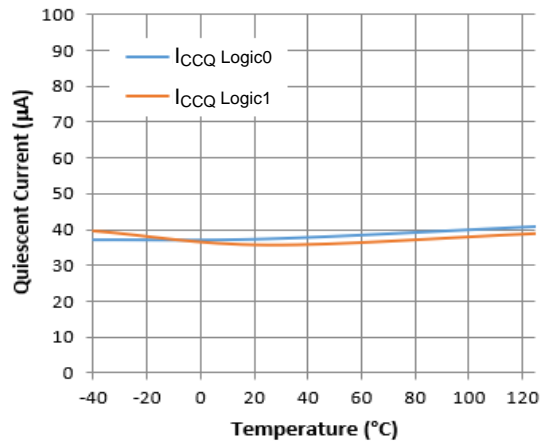

Figure 11. Quiescent Current vs. Temperature

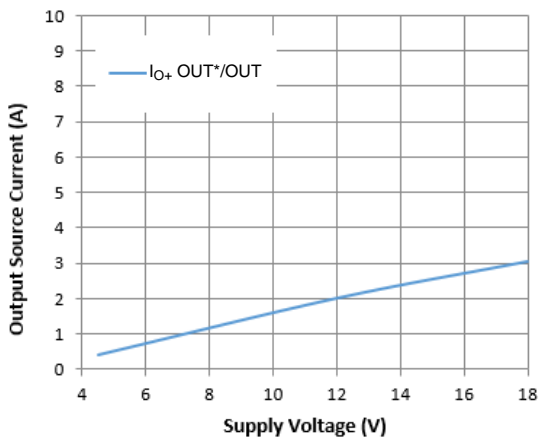

Figure 12. Output Source Current vs. Supply Voltage

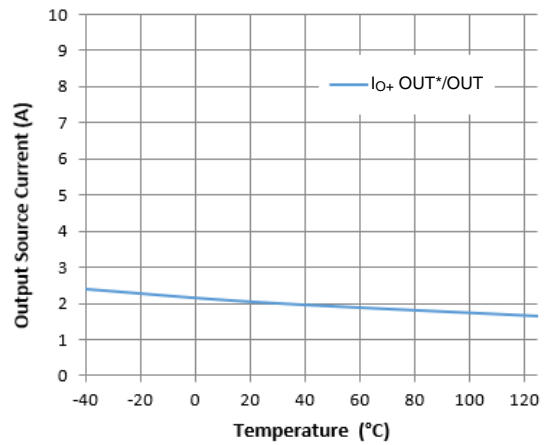

Figure 13. Output Source Current vs. Temperature

Typical Performance Characteristics (Cont.)

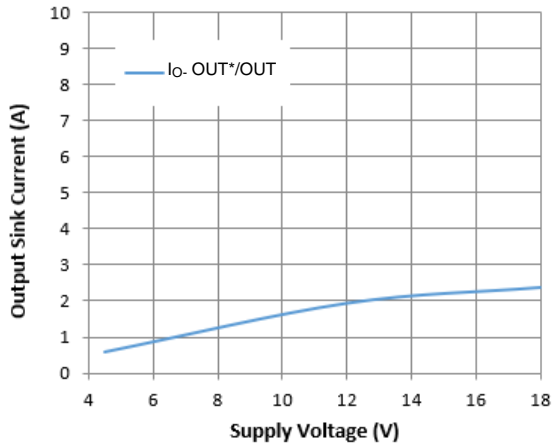

Figure 14. Output Sink Current vs. Supply Voltage

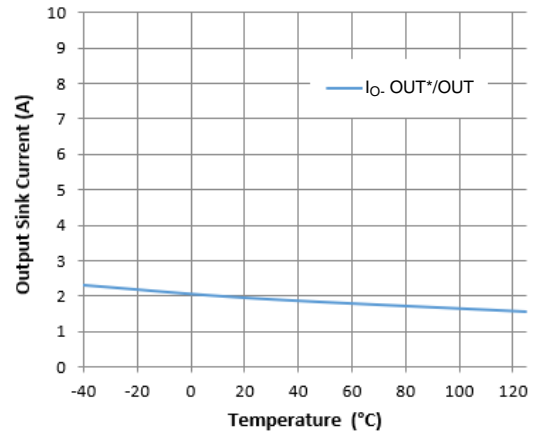

Figure 15. Output Sink Current vs. Temperature

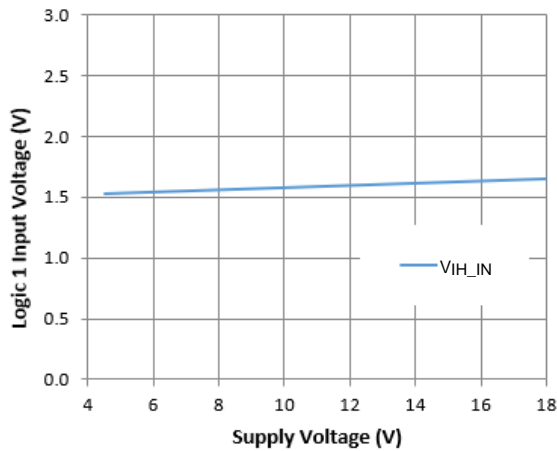

Figure 16. Logic 1 Input Voltage vs. Supply Voltage

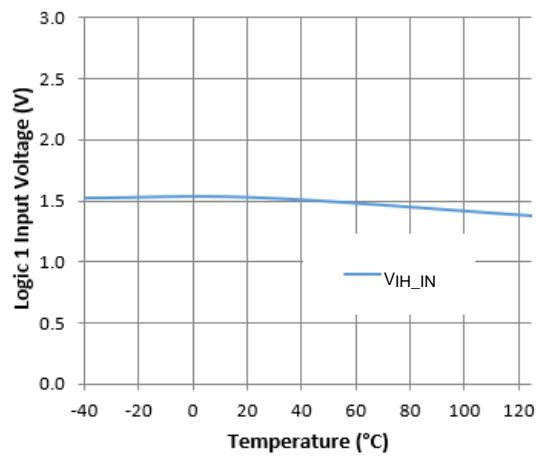

Figure 17. Logic 1 Input Voltage vs. Temperature

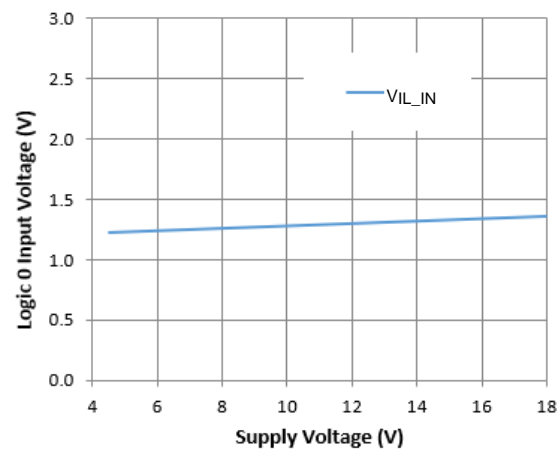

Figure 18. Logic 0 Input Voltage vs. Supply Voltage

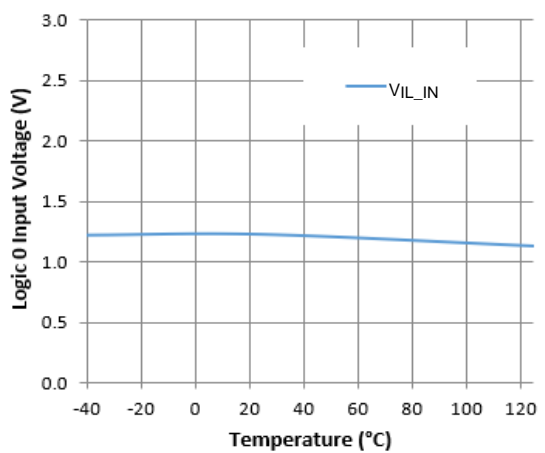
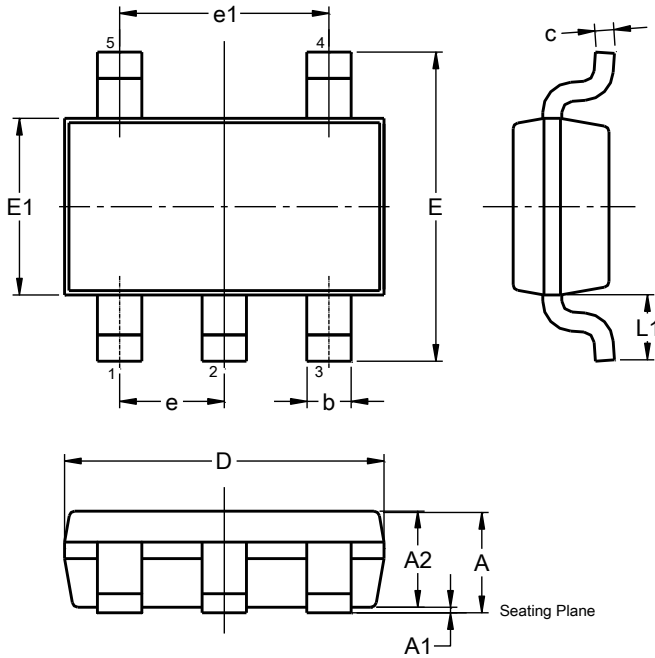

Figure 19. Logic 0 Input Voltage vs. Temperature

Package Outline Dimensions

Please see <http://www.diodes.com/package-outlines.html> for the latest version.

TSOT25 (Type TH)



TSOT25 (Type TH)			
Dim	Min	Max	Typ
A	--	1.10	--
A1	0.01	0.10	--
A2	0.70	1.00	0.90
b	0.30	0.50	--
c	0.08	0.20	--
D	2.90 BSC		
E	2.80 BSC		
E1	1.60 BSC		
e	0.95 BSC		
e1	1.90 BSC		
L1	0.60 REF		
All Dimensions in mm			

Suggested Pad Layout

Please see <http://www.diodes.com/package-outlines.html> for the latest version.

TSOT25 (Type TH)

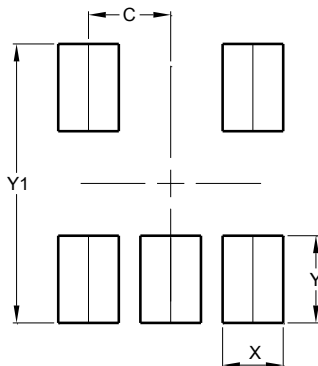

Dimensions	Value (in mm)
C	0.950
X	0.700
Y	1.000
Y1	3.199

IMPORTANT NOTICE

DIODES INCORPORATED MAKES NO WARRANTY OF ANY KIND, EXPRESS OR IMPLIED, WITH REGARDS TO THIS DOCUMENT, INCLUDING, BUT NOT LIMITED TO, THE IMPLIED WARRANTIES OF MERCHANTABILITY AND FITNESS FOR A PARTICULAR PURPOSE (AND THEIR EQUIVALENTS UNDER THE LAWS OF ANY JURISDICTION).

Diodes Incorporated and its subsidiaries reserve the right to make modifications, enhancements, improvements, corrections or other changes without further notice to this document and any product described herein. Diodes Incorporated does not assume any liability arising out of the application or use of this document or any product described herein; neither does Diodes Incorporated convey any license under its patent or trademark rights, nor the rights of others. Any Customer or user of this document or products described herein in such applications shall assume all risks of such use and will agree to hold Diodes Incorporated and all the companies whose products are represented on Diodes Incorporated website, harmless against all damages.

Diodes Incorporated does not warrant or accept any liability whatsoever in respect of any products purchased through unauthorized sales channel. Should Customers purchase or use Diodes Incorporated products for any unintended or unauthorized application, Customers shall indemnify and hold Diodes Incorporated and its representatives harmless against all claims, damages, expenses, and attorney fees arising out of, directly or indirectly, any claim of personal injury or death associated with such unintended or unauthorized application.

Products described herein may be covered by one or more United States, international or foreign patents pending. Product names and markings noted herein may also be covered by one or more United States, international or foreign trademarks.

This document is written in English but may be translated into multiple languages for reference. Only the English version of this document is the final and determinative format released by Diodes Incorporated.

LIFE SUPPORT

Diodes Incorporated products are specifically not authorized for use as critical components in life support devices or systems without the express written approval of the Chief Executive Officer of Diodes Incorporated. As used herein:

A. Life support devices or systems are devices or systems which:

1. are intended to implant into the body, or
2. support or sustain life and whose failure to perform when properly used in accordance with instructions for use provided in the labeling can be reasonably expected to result in significant injury to the user.

B. A critical component is any component in a life support device or system whose failure to perform can be reasonably expected to cause the failure of the life support device or to affect its safety or effectiveness.

Customers represent that they have all necessary expertise in the safety and regulatory ramifications of their life support devices or systems, and acknowledge and agree that they are solely responsible for all legal, regulatory and safety-related requirements concerning their products and any use of Diodes Incorporated products in such safety-critical, life support devices or systems, notwithstanding any devices- or systems-related information or support that may be provided by Diodes Incorporated. Further, Customers must fully indemnify Diodes Incorporated and its representatives against any damages arising out of the use of Diodes Incorporated products in such safety-critical, life support devices or systems.

Copyright © 2019, Diodes Incorporated

www.diodes.com