

C TJS-108

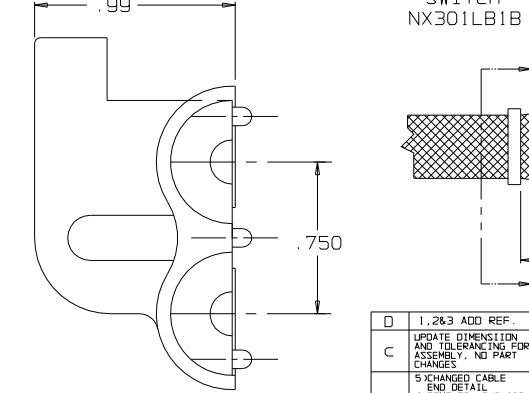
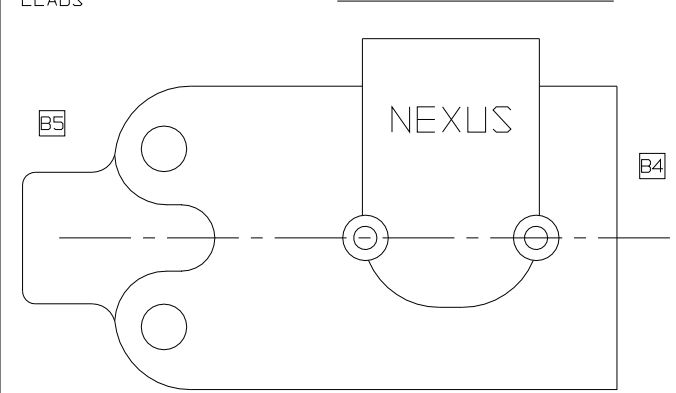
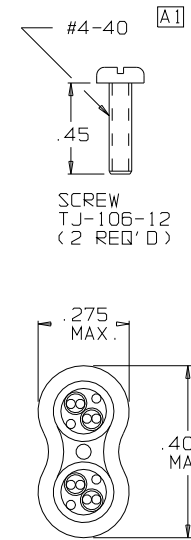
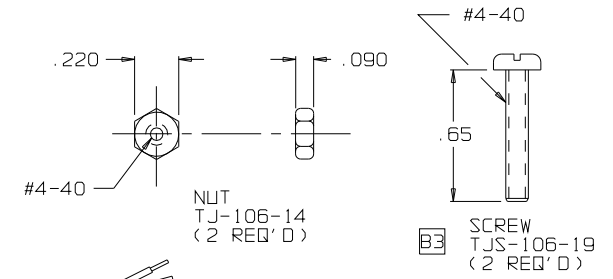
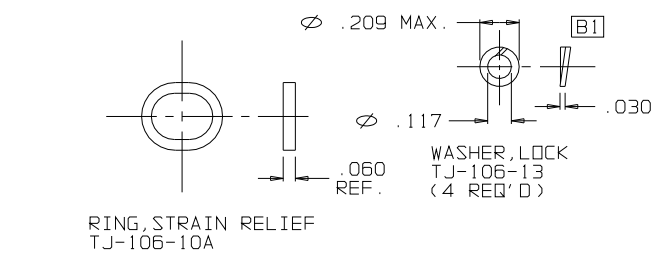
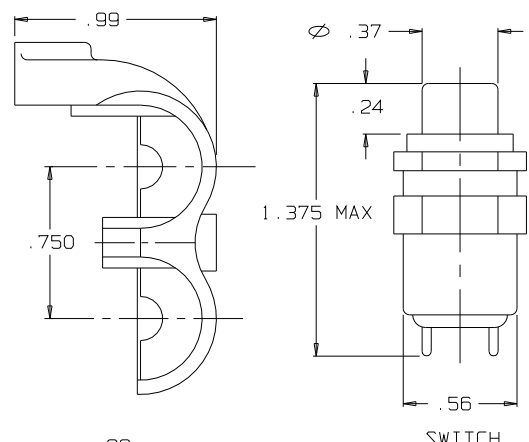
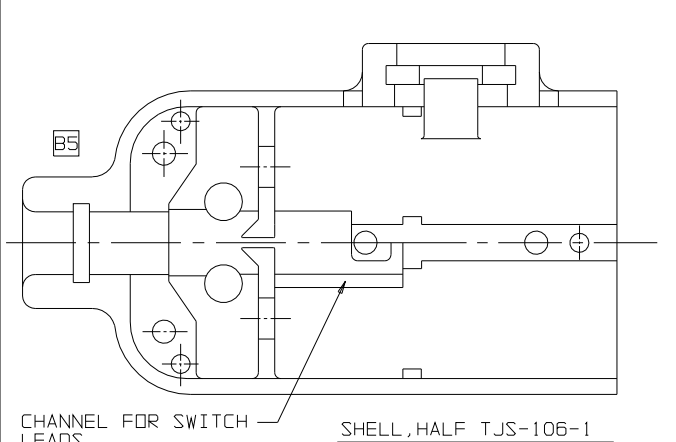
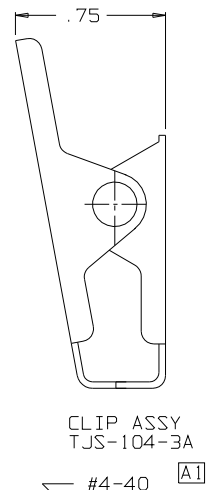
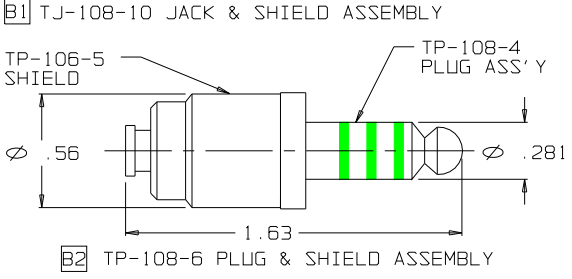
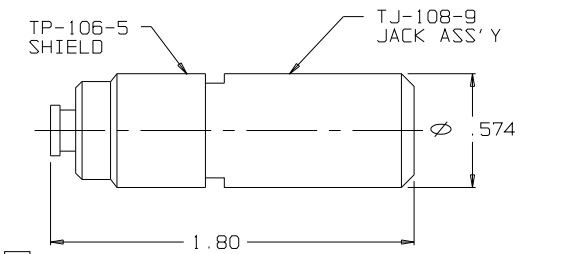

THIS DOCUMENT CONTAINS PROPRIETARY INFORMATION OF NEXUS, INCORPORATED AND SUCH INFORMATION MAY NOT BE DISCLOSED TO OTHERS FOR ANY PURPOSE OR USED FOR ANY PURPOSE WITHOUT THE WRITTEN CONSENT OF NEXUS.

D	1.263 ADD REF.	031	11/2/09	GPH	DWN BY M.N.F.	DATE 2/19/96	MATERIAL	
C	UPDATE DIMENSION AND TOLERANCING FOR ASSEMBLY. NO PART CHANGES	506	8/19/95	EWT	CHECKED BY L.SMITH	DATE 3/14/96	FINISH	
B	5 EXCHANGED CABLE END DETAIL 4 REMOVED TJS-106-3 3 WAS TJS-106-3 2 ADDED TJ-108-6 1 ADDED TJ-108-10	444	8/19/93	EWT	APPR BY L.SMITH	DATE 3/14/96	WEIGHT	SCALE 2:1
A	1 WAS TJS-104-3	0302	10/7/98	EWT	UNLESS OTHERWISE SPECIFIED DIMENSIONS ARE IN INCHES TOLERANCES ON FRACTIONS DECIMALS		TITLE	JACK-TELEPHONE-BIAXIAL SHIELDED (8) CONDUCTOR WITH SWITCH
E	1 WAS 0.195	ECN041	1/2/10	GPH	LET. REVISION	CN #	DATE	CHK
							DO NOT SCALE DWG.	SHEET 1 OF 1

NEXUS
STAMFORD, CONN

SIZE DWG. NO.
C TJS-108