

Blade Fuse Holders - FKH Stackable Fuse Holder for ATO® Style Blade Fuse Rated 58V

RoHS



Specifications

Housing + Adapter: Out of thermoplastic (UL 94-V0, heat-resistant)
Connections: Leaf spring connector systems, soldering terminals (4 pins each), copper alloy, tinned
Color: Black
Packaging:

Series	Pack Size
178.4250.xxx2	1000
178.4252.xxx2	1000
178.6116.xxx1	200
178.6116.xxx2	1000
178.619x.xxx1	100

Fuse Holder for 42V PowerNet with coding for TAC fuses-links. Attachable in X - direction. Rated voltage 58V; crimp terminals.

Sicherungshalter für 42V PowerNet, mit Kodierung für TAC-Sicherungen. Montage in X-Richtung. Nennspannung 58V, Crimp-Kontakte.

Dimensions in mm / Maße in mm

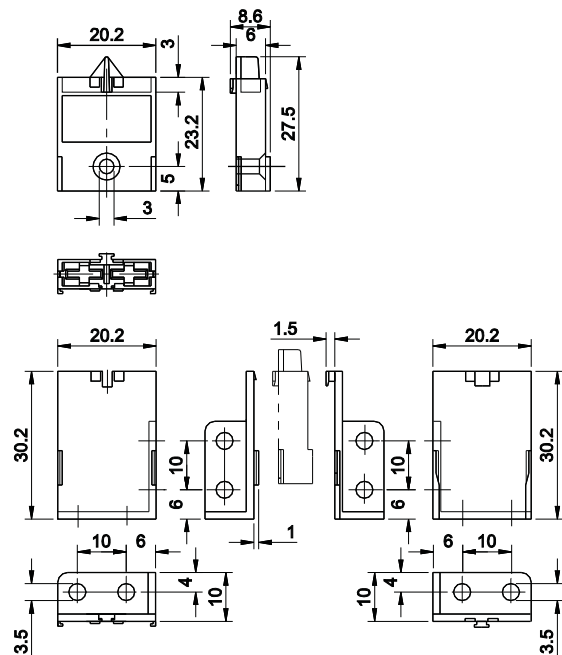
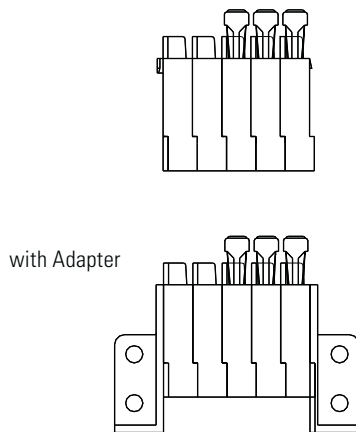

Fuse Holders

Part Number Artikel-Nr.	Description Beschreibung	Contact Temperature Kontakttemperatur
178.4252.000_	Complete with Housing and 2 Terminals	max. 130°C
178.4250.000_	Housing	-
178.6116.250_	Contacts 1.5 - 2.5 mm ²	max. 130°C
178.6191.000_	Adapter right	-
178.6192.000_	Adapter left	-

Corresponding fuse links see Section "Blade Fuses."

This FKH 58V Fuse Holder can be mounted in row in any number. The fixing adapters are not included in the Fuse Holder. Please order the adapter separately.

Blade Fuseholders - FKH Stackable Fuseholder for ATO® Style Blade Fuse Rated 80V

RoHS



Specifications

Housing + Adapter: Out of thermoplastic (UL 94-V0, heat-resistant)
Connections: Leaf spring connector systems, soldering terminals, copper alloy, tinned
Color: Black

Dimensions in mm / Maße in mm

Fuseholder for ATO / FKS size fuses-links. Attachable in X - direction. Rated voltage 80V; crimp terminals.

Sicherungshalter für Sicherungen in ATO / FKS-Größe. Montage in X-Richtung. Nennspannung 80V, Crimp-Kontakte.

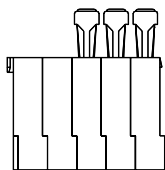
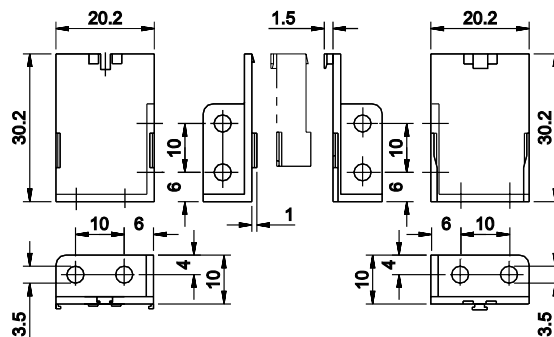
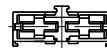
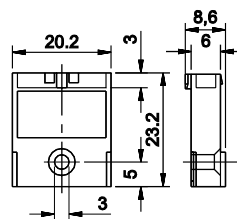

with Adapter

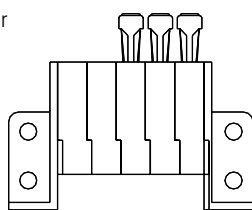

Part Number Artikel-Nr.	Description Beschreibung	Contact Temperature Kontakttemperatur
178.6152.000_	Complete	max. 130°C
178.6150.000_	Housing	-
178.6116.250_	Complete with 1.5 - 2.5 mm ²	max. 130°C
178.6152.250_	With 200 mm wiring loop	-
178.6191.000_	Adapter right	-
178.6192.000_	Adapter left	-

Last figure of part number = packaging code, see Section "Packaging Index," pg. 157.

Corresponding fuse links see Section "Blade Fuses."

This FKH-Fuseholder can be mounted in row in any number. The fixing adapters are not included in the fuseholder. Please order the adapter separately.

Blade Fuse Holders - FKH Fuse Holder with 90° connection for ATO® Style Blade Fuse Rated 80V

RoHS



Specifications

Housing: Out of thermoplastic (UL 94-V0, heat-resistant)
Connections: Leaf spring connector systems, soldering contacts (2 pins), copper alloy, tinned
Color: Black

Packaging:

Series	Pack Size
178.7017.xxx1	100

Fuse Holders
PCB

Fuse Holder for ATO® / FKS size fuses-links. 90° bended solderable tin plated contacts. Rated voltage 80V.

Sicherungshalter für Sicherungen in ATO® / FKS-Größe. 90°-gewinkelte, verzinnnte Lötanschlüsse. Nennspannung 80V.

Dimensions in mm / Maße in mm

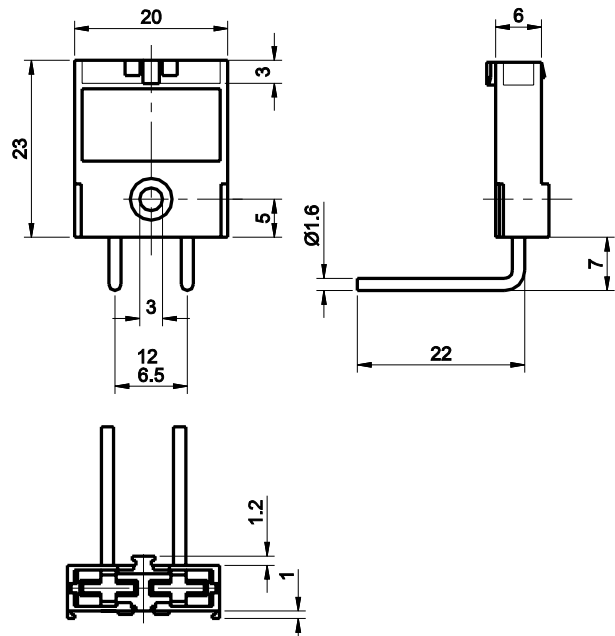

Part Number Artikel-Nr.	Description Beschreibung	Contact Temperature Kontakttemperatur
178.7017.0001	Complete	max. 130°C

Corresponding fuse links see Section "Blade Fuses."