

MS-Series

CIRCUIT BREAKER

Designed and tested to operate flawlessly in the harshest of environments, the MS-Series sealed toggle circuit breaker is ideally suited for COTS (commercial off the shelf) military applications. Our space saving envelope meets IP68 requirements and features a durable metal and sealed mounting bushing with MIL-PRF-39019F ingress protection when mounted in a panel.

This class-leading, affordable circuit breaker was designed in accordance with the requirements of MIL-PRF-55629 and MIL STD 202, making it the best choice for those applications where shock, vibration, moisture resistance, salt spray and thermal shock are of the utmost consideration. The MS-Series' compact size and reliability make it ideal for crucial communication equipment and other mission critical components.

1-3 poles; 0.02-30 amps; 65VDC, 240VAC, 120/240VAC; UL, cUL recognized & TUV pending.



Resources:

[Download 3D CAD Files](#)



[Watch Product Video](#)



Product Highlights:

- ♦ Sealed Toggle Actuator
- ♦ MIL-PRF-39019F Ingress Protection
- ♦ MIL-PRF-55629 and MIL STD 202 Compliant
- ♦ Compact Design

Typical Applications:

- ♦ COTS Military
 - Communication Equipment
- ♦ Off Highway Equipment
 - Construction, Mining & Agriculture
- ♦ Generators & Power Supplies
- ♦ Harsh Environment Applications



Carling Technologies, Inc.
60 Johnson Avenue, Plainville, CT 06062
Email: sales@carlingtech.com
Application Support: team2@carlingtech.com
Phone: 860.793.9281 Fax: 860.793.9231

www.carlingtech.com

MS-Series

DESIGN FEATURES

SEALS

IP68 Designed and tested to comply with MIL-PRF-39019F Ingress Protection

COMPACT SIZE

Max performance in compact size: 0.20-30 Amps; 65 VDC, 240 VAC 120/240 VAC

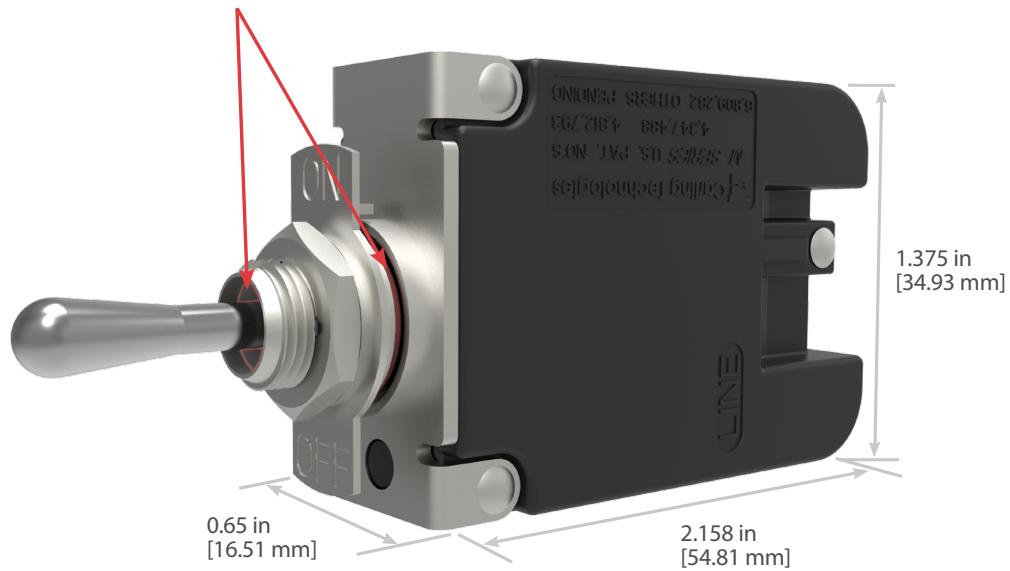

TERMINAL BARRIERS

Meet UL 1077 Spacing Requirements

OPTIONAL AUXILIARY SWITCH

Provides Breaker Status Indication

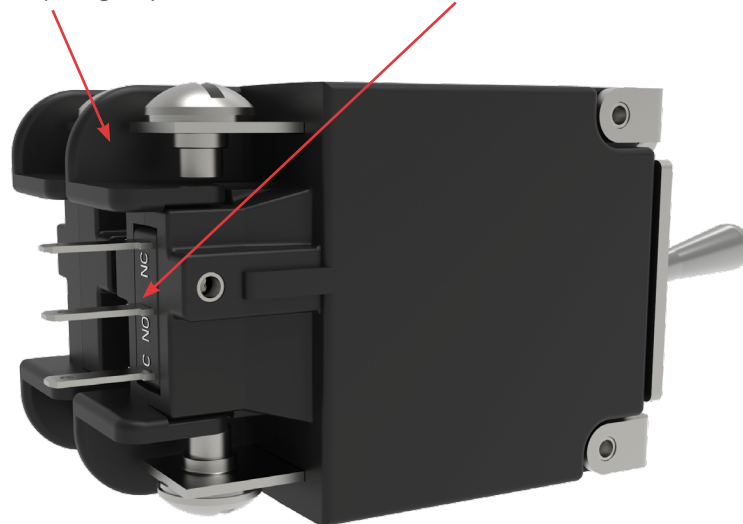

Electrical Tables

Table A: Lists UL & cUL Configuration & Performance Capabilities

MS-SERIES TABLE A: COMPONENT SUPPLEMENTARY PROTECTORS							
Circuit Configuration	Voltage			Current Rating		Short Circuit Capacity (Amps) ¹	
	Max Rating	Frequency	Phase	General Purpose Amps	Poles Breaking	UL / cUL	
						U1	U3
Series	65	DC	---	0.02 - 30	1	3000	300
	240	50 / 60	1	0.02 - 30	1, 2	2000	300
	120 / 240	50 / 60	1	0.02 - 30	2 or 3	2000	300

Notes:

1 Short Circuit Current Rating (SC) Codes — The short-circuit current rating, followed by a letter and number designating the test conditions and any calibration following the short-circuit test as defined below:

U - Indicates that the short circuit test was performed without a series fuse

1 - Indicates that a re-calibration was not performed as part of the short circuit testing

3 - Indicates that the protector has proven to be suitable for further use after the short circuit test

Re-calibration, dielectric strength and voltage withstand tests were performed after the short circuit testing

Electrical

Current Ratings	.02 - 30 Amps
Voltage Rating	65VDC, 240VAC, 120/240VAC
Short Circuit Rating	See Table A
Auxiliary Switch Rating	5A @ 125VAC, 3A @ 32VDC, .1A @ 125VAC, 32VDC
Dielectric Strength	UL,CSA 1500V, 50/60 Hz for one minute between all electrically isolated terminals.
Insulation Resistance	Minimum of 100 Megohms @ 500VDC
Time Delay	See delay curve
Impedance	

RESISTANCE, IMPEDANCE VALUES from Line to Load Terminals (Values Based on Series Trip Circuit Breaker)

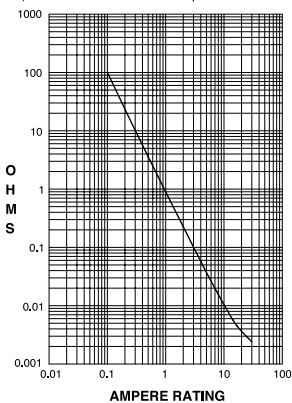

CURRENT (AMPS)	TOLERANCE (%)
0.20 - 30.0	25%

Physical

Number of Poles	1-3 poles
Weight	Approximately 1.8 oz (50 G) per pole
Dimensions	See form & fit drawing

Agency Certifications

UL Standard 1077



CUL Standard C22.2

Mechanical

Current Ratings	10,000 On-Off operations @ 6 per minute with rated current and voltage.
Trip Free	Trips on short circuit and overload, even when the actuator is forcibly held in the "On" position.
Trip Indication	The operating handle moves positively to the "Off" position when a short circuit or overload causes the circuit breaker to trip.

Environmental

Designed in accordance with requirements of specification MIL PRF-55629 & MIL-STD-202G as follows:	
Shock	Withstands 100G's, 6ms, saw tooth while carrying rated current per Method 213, Condition I. Instantaneous curves tested at 80% of rated current.
Vibration	Withstands 0.060" excursion from 10-55 Hz, and 10G's 55-500 Hz, at rated current per Method 204C, Test Condition A. Instantaneous curves tested at 80% of rated current.
Salt Spray	Method 101, Condition A (90-95% RH @ 5% NaCl Solution, 96 hrs)
Moisture Resistance	Method 106G
Thermal Shock	Method 107D, Condition A (Five cycles @ -55°C to +25°C to +85°C to +25°C)
Operating Temperature	-40°C to +85°C
Ingress Protection Level	MIL-PRF-55629C when mounted in panel.
Other	Materials used in this product are non-nutrient to fungus growth.

*Manufacturer reserves the right to change product specification without prior notice.

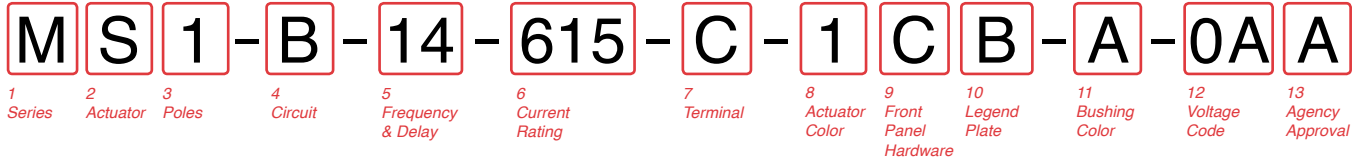

1 SERIES
M

2 ACTUATOR
S Sealed Toggle

3 POLES
1 One 2 Two 3 Three

4 CIRCUIT
A Switch Only (no coil)^{1,2}
B Series Trip (current)
M Series Trip (current) Aux switch .110 QC x 0.20 QC (silver contacts)
9 Series Trip (current) Aux switch .110 QC x 0.20 QC (gold contacts)

5 FREQUENCY & DELAY

03 DC, 50/60 Hz, Switch Only ¹	32 DC, 50/60 Hz Short
10 DC, Instantaneous	34 DC, 50/60 Hz Medium
12 DC, Short	62 50/60 Hz Short, Hi-Inrush ⁴
14 DC, Medium	64 50/60 Hz Medium, Hi-Inrush ⁴
20 50/60 Hz Instantaneous	72 DC, Short, High-Inrush ⁴
22 50/60 Hz Short	74 DC, Medium, High-Inrush ⁴
24 50/60 Hz Medium	92 DC, 50/60 Hz Short, Hi-Inrush ⁴
30 DC, 50/60 Hz Instantaneous	94 DC, 50/60 Hz Medium, In-rush ⁴

6 CURRENT RATING (AMPERES)

CODE	AMPERES				
220	0.200	295	0.950	460	6.00
225	0.250	410	1.00	465	6.50
230	0.300	512	1.25	470	7.00
235	0.350	415	1.50	475	7.50
240	0.400	517	1.75	480	8.00
245	0.450	420	2.00	485	8.50
250	0.500	522	2.25	490	9.00
255	0.550	425	2.50	495	9.50
260	0.600	527	2.75	610	10.00
265	0.650	430	3.00	710	10.50
270	0.700	435	3.50	611	11.00
275	0.750	440	4.00	711	11.50
280	0.800	445	4.50	612	12.00
285	0.850	450	5.00	712	12.50
290	0.900	455	5.50	613	13.00

7 TERMINAL
1 Push-On 0.250 Tab (QC)
2 Screw 8-32 (Upturned Lugs)
3 Screw 8-32 (Bus Type)
C Screw Terminal M4 (Upturned Lugs)
E Screw Terminal M4 (Bus Type)
L Solder Lug

8 ACTUATOR & MARKING COLOR
1 Dull Metallic

9 FRONT PANEL HARDWARE
A No Outer Panel Hardware
B Hex Nut, Nickel Plated
C Hex Nut, Nickel Plated with Locking Ring
F Panel Dress Nut, Nickel Plated
G Panel Dress Nut, Nickel Plated with Locking Ring

10 LEGEND PLATE
A No Legend Plate
B On-Off Vertical
C On-Off Horizontal
D I-O Vertical
E I-O Horizontal
F Dual Vertical
G Dual Horizontal

11 BUSHING COLOR
A Nickel Plated / Multipole Version

12 VOLTAGE CODE
0A 65 VDC
0D 240 VAC
0C 120/240 VAC³
0N 65 VDC / 120/240 VAC³
17 65 VDC / 240 VAC

13 AGENCY APPROVAL
A Without approvals
B UL Recognized
C UL & cUL Recognized

Notes:
1 Series code "A" only available with delay code "03"
2 Only available when tied to a protected pole
3 Requires a 2 or 3 pole device
4 Only available without agency approvals (Approval Code A)

Form & Fit



- Notes:
 1 All dimensions are in inches [millimeters].
 2 Tolerance ±.020 [.51] unless otherwise specified.

Delay Curve

Dual Rated AC/DC

Instantaneous

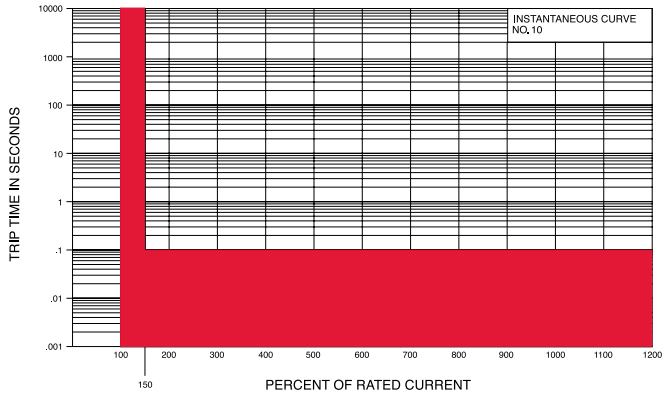

Short

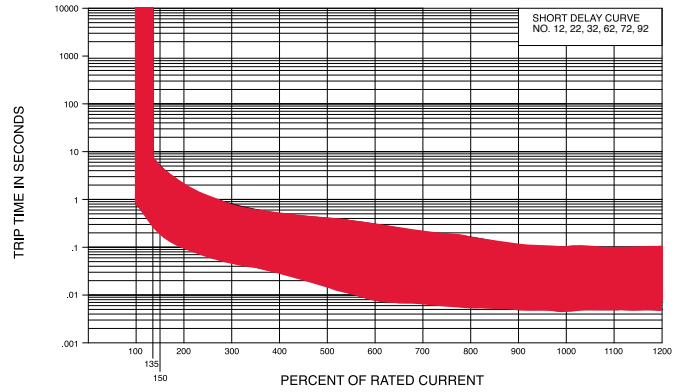

Medium

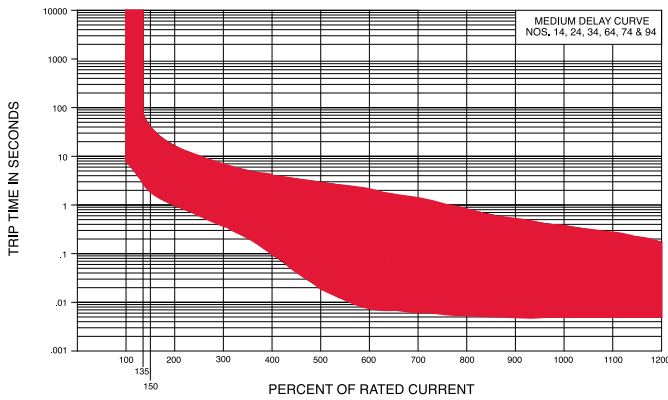

Authorized Sales Representatives

Click on the group name on the map below to find your local representative or visit www.carlingtech.com/findarep.

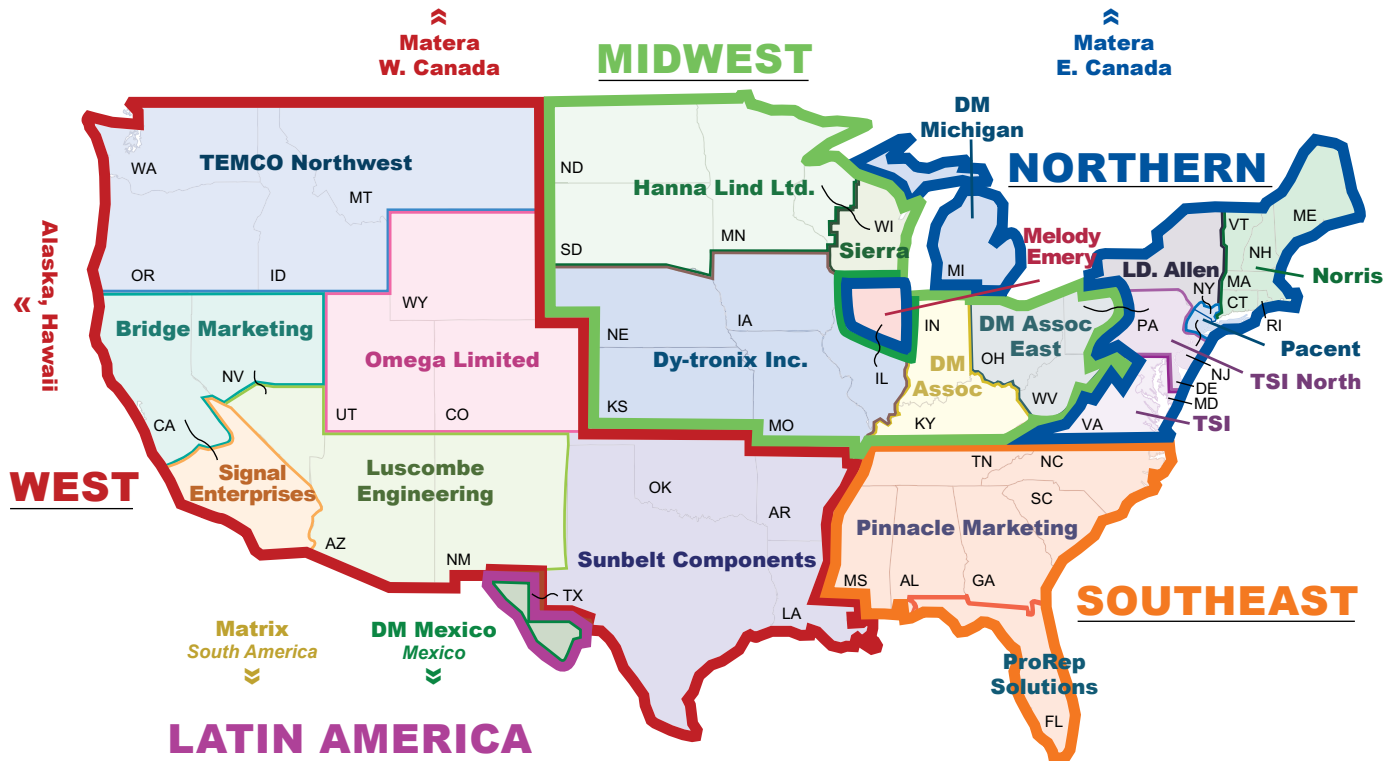

Americas



Europe
Middle East
Africa



Asia-Pacific
Oceania

About Carling

Founded in 1920, Carling Technologies is a leading manufacturer of electrical and electronic switches and assemblies, circuit breakers, electronic controls, power distribution units, and multiplexed power distribution systems. With four ISO registered manufacturing facilities and technical sales offices worldwide, Carling Technologies Sales, Service and Engineering teams do much more than manufacture electrical components, they engineer powerful solutions! To learn more about Carling please visit www.carlingtech.com/company-profile.

To view all of Carling's environmental, quality, health & safety certifications please visit www.carlingtech.com/environmental-certifications

Worldwide Headquarters

Carling Technologies, Inc.
60 Johnson Avenue, Plainville, CT 06062
Phone: 860.793.9281 **Fax:** 860.793.9231
Email: sales@carlingtech.com

Northern Region Sales Office: nrsm@carlingtech.com
Southeast Region Sales Office: sersm@carlingtech.com
Midwest Region Sales Office: mrrsm@carlingtech.com
West Region Sales Office: wrsm@carlingtech.com
Latin America Sales Office: larsm@carlingtech.com

Asia-Pacific Headquarters

Carling Technologies, Asia-Pacific Ltd.,
Kowloon, Hong Kong
Phone: Int + 852-2737-2277 **Fax:** Int + 852-2736-9332
Email: sales@carlingtech.com.hk

Shenzhen, China: shenzhen@carlingtech.com
Shanghai, China: shanghai@carlingtech.com
Pune, India: india@carlingtech.com
Kaohsiung, Taiwan: taiwan@carlingtech.com
Yokohama, Japan: japan@carlingtech.com

Europe | Middle East | Africa Headquarters

Carling Technologies LTD
4 Airport Business Park, Exeter Airport,
Clyst Honiton, Exeter, Devon, EX5 2UL, UK
Phone: Int + 44 1392.364422 **Fax:** Int + 44 1392.364477
Email: ltd.sales@carlingtech.com

Germany: gmbh@carlingtech.com
France: sas@carlingtech.com



Carling Technologies™

Innovative Designs. Powerful Solutions.