

SF526V/35VF/35VM/25in Microwave Cable Assembly

Description

SUCOFLEX 526V microwave cable assemblies set a new measurement standard for vector network analyzers (VNAs) through 26.5 GHz.

- Extremely flexible and ease of handling
- Best-in-class phase and amplitude stability with flexure, movement, temperature and tensile stress
- Robust and precise center positioning of 3.5mm center conductors
- Accurate and repeatable measurements
- Increased test efficiency and measurement saving costs due to reduced calibration intervals



Product Configuration

Description	SF526V/35VF/35VM/25in
Item no	85069744
Cable type	SUCOFLEX 526V
Length of assembly	25" (635 mm)
Connector A	35VF (3.5 mm ruggedized PORT female)
Connector B	35 VM (3.5 mm ruggedized DUT male)

Technical Data

Mechanical Data

Nominal outer diameter	13.0 mm
Min. bending radius	50 mm
Crush resistance	80 kN/m
Nominal weight	270 g
Flex life	100'000 cycles

Environmental Data

Operating temperature	Laboratory conditions, analyzer specific (+15°C to +30°C)
RoHS, REACH	Compliant

Electrical Data

Impedance	50 Ω	
Operating frequency	up to 26.5 GHz	
Velocity of propagation	80 %	
Time delay	4.17 ns / m	
Return loss	min. 20 dB	up to 26.5 GHz
Return loss stability	> 40 dB	up to 26.5 GHz
Insertion loss (assembly)	max. 2.5 dB	26.5 GHz, 25°C
Screening effectiveness	> 90 dB	up to 26.5 GHz
Amplitude stability vs. movement (*)	max. 0.05 dB	up to 26.5 GHz
Amplitude stability vs. flexure (**)	max. 0.08 dB	up to 26.5 GHz
Phase stability vs. flexure (**)	max. 3.9°	up to 26.5 GHz
Phase stability vs. tensile stress	max. 0.1° / GHz	100 N, up to 26.5 GHz
Phase stability vs. temperature	max. 50 ppm	15°C to 30°C, up to 26.5GHz

(*) Stability test vs. movement 30s, displacement: 100 mm

(**) Stability test vs. flexure 180°, diameter 115 mm

SF526V/35VF/35VM/25inch Microwave Cable Assembly

Phase vs. temperature performance

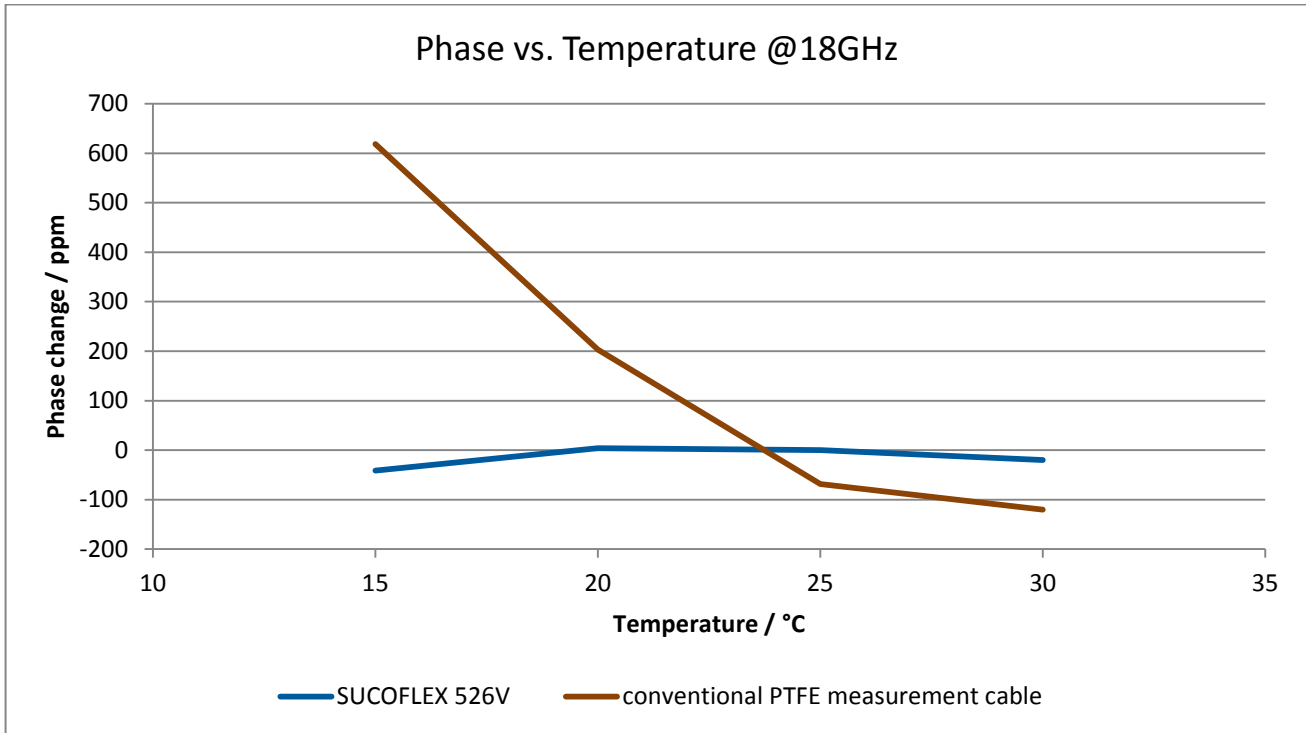

Phase shift vs. temperature (+15°C to + 30°C)

		SUCOFLEX 526V	Conventional VNA test lead
Assembly length (in (mm))	Frequency (GHz)*	Phase shift /° (for 50 ppm, 80% VOP)	Phase shift /° (for 700 ppm, 84% VOP)
25 (635)	18	0.9	11.4
25 (635)	26.5	1.3	16.7

*Other frequencies on request

Connector configuration

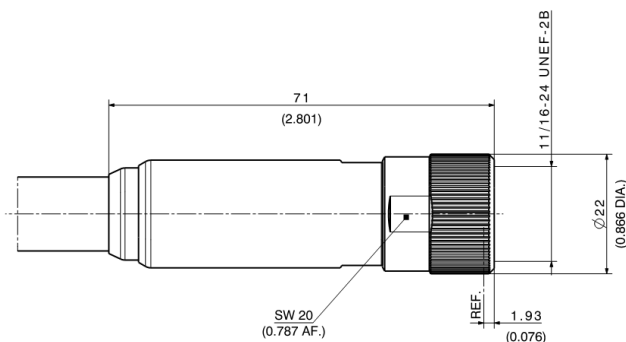

Figure 1: 35 VF (3.5 mm ruggedized PORT female)

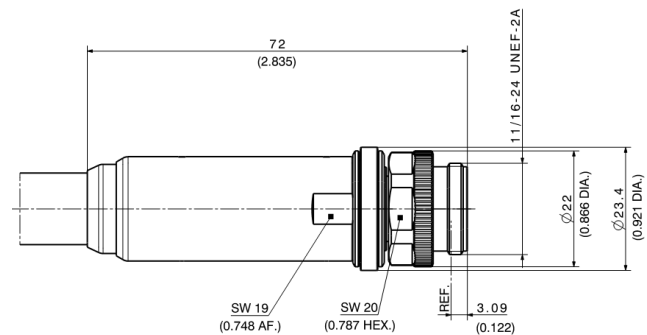

Figure 2: 35 VM (3.5 mm ruggedized DUT male)