

Chip Ferrite Bead BLM21□□□□□□Z1□
Murata Standard Reference Specification[AEC-Q200]

1. Scope

This reference specification applies to Chip Ferrite Bead for Automotive Electronics BLM21_SZ Series based on AEC-Q200 except for Power train and Safety.

2. Part Numbering

(ex.) BL M 21 AG 121 S Z 1 D
 (1) (2) (3) (4) (5) (6) (7) (8) (9)

(1)Product ID
 (2)Type
 (3)Dimension (L×W)
 (4)Characteristics
 (5)Typical Impedance at 100MHz
 (6)Performance

(7)Category (for Automotive Electronics)
 (8)Numbers of Circuit
 (9)Packaging

D:Taping(φ 180mm Reel, Paper Tape)
L:Taping(φ 180mm Reel, Plastic Tape)

3. Rating

Customer Part Number	MURATA Part Number	Impedance (Ω) (at 100MHz) (*1) (refer to below comment)	Rated Current (mA)(*2)			DC Resistance (Ω) max. (*1) (refer to below comment)		ESD Rank 2:2kV 6:25kV
			Typical	at 85°C	at 125°C	Initial Values	Values After Testing	
	BLM21PG220SZ1D	22±25%	22	*2 6000	*2 3300	0.009	0.018	2
	BLM21PG300SZ1D	20 min.	30	*2 4000	*2 2300	0.014	0.028	
	BLM21PG600SZ1D	60±25%	60	*2 3500	*2 1900	0.02	0.04	
	BLM21PG121SZ1D	120±25%	120	*2 3000	*2 1550	0.03	0.06	
	BLM21PG221SZ1D	220±25%	220	*2 2000	*2 1250	0.045	0.09	
	BLM21PG331SZ1D	330±25%	330	*2 1500	*2 1000	0.07	0.14	
	BLM21SN300SZ1D	30±10Ω	30	*2 8500	*2 6000	0.004	0.005	
	BLM21SP700SZ1D	70±25%	70	*2 6000	*2 4000	0.009	0.012	
	BLM21SP111SZ1D	110±25%	110	*2 5000	*2 3300	0.013	0.016	
	BLM21SP181SZ1D	180±25%	180	*2 4000	*2 2600	0.020	0.025	
	BLM21SP331SZ1D	330±25%	330	*2 2800	*2 1900	0.040	0.051	
	BLM21SP471SZ1D	470±25%	470	*2 2500	*2 1700	0.050	0.063	
	BLM21SP601SZ1D	600±25%	600	*2 2300	*2 1500	0.060	0.074	
	BLM21SP102SZ1D	1000±25%	1000	*2 1600	*2 1100	0.120	0.144	

Customer Part Number	MURATA Part Number	Impedance (Ω) (at 100MHz) (*1) (refer to below comment)	Rated Current (mA)(*2)			DC Resistance (Ω) max. (*1) (refer to below comment)		ESD Rank 2:2kV 6:25kV
			Typical	at		Initial Values	Values After Testing	
				85°C	125°C			
	BLM21BB050SZ1D	5±25%	5	1000	0.02	0.04	2	
	BLM21BB600SZ1D	60±25%	60	800	0.13	0.23		
	BLM21BB750SZ1D	75±25%	75	700	0.16	0.26		
	BLM21BB121SZ1D	120±25%	120	600	0.19	0.29		
	BLM21BD121SZ1D	120±25%	120	350	0.25	0.35		
	BLM21BB151SZ1D	150±25%	150	600	0.21	0.31		
	BLM21BD151SZ1D	150±25%	150	350	0.25	0.35		
	BLM21BB201SZ1D	200±25%	200	500	0.26	0.36		
	BLM21BB221SZ1D	220±25%	220	500	0.26	0.36		
	BLM21BD221SZ1D	220±25%	220	350	0.25	0.35		
	BLM21BB331SZ1D	330±25%	330	400	0.33	0.43		
	BLM21BD331SZ1D	330±25%	330	300	0.3	0.4		
	BLM21BD421SZ1D	420±25%	420	300	0.3	0.4		
	BLM21BB471SZ1D	470±25%	470	400	0.4	0.5		
	BLM21BD471SZ1D	470±25%	470	300	0.35	0.45		
	BLM21BD601SZ1D	600±25%	600	300	0.35	0.45		
	BLM21BD751SZ1D	750±25%	750	250	0.4	0.5		
	BLM21BD102SZ1D	1000±25%	1000	250	0.4	0.5		
	BLM21BD152SZ1D	1500±25%	1500	250	0.45	0.55		
	BLM21BD182SZ1D	1800±25%	1800	250	0.5	0.6		
	BLM21BD222SZ1L	1600 min.	2250	250	0.6	0.7		
	BLM21BD222TZ1D	2200±25%	2200	200	0.6	0.7		
	BLM21BD272SZ1L	2700±25%	2700	200	0.8	0.9		
	BLM21AG121SZ1D	120±25%	120	1000	0.09	0.19		
	BLM21AG151SZ1D	150±25%	150	1000	0.09	0.19		
	BLM21AG221SZ1D	220±25%	220	900	0.12	0.22		
	BLM21AG331SZ1D	330±25%	330	800	0.15	0.25		
	BLM21AG471SZ1D	470±25%	470	700	0.18	0.28		
	BLM21AG601SZ1D	600±25%	600	700	0.2	0.3		
	BLM21AG102SZ1D	1000±25%	1000	600	0.27	0.37		

• Operating Temperature : -55°C to +125°C

• Storage Temperature : -55°C to +125°C

(*1)

Standard Testing Conditions

< Unless otherwise specified >

Temperature : Ordinary Temp. (15 °C to 35 °C)

Humidity : Ordinary Humidity (25%(RH) to 85%(RH))

< In case of doubt >

Temperature : 20°C±2 °C

Humidity : 60%(RH) to 70%(RH)

Atmospheric pressure : 86kPa to 106kPa

(Note)As for Rated current marked with *2,
Rated Current is derated as right figure
depending on the operating temperature.

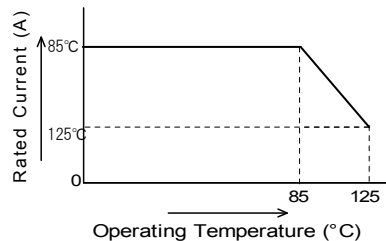

4. Style and Dimensions

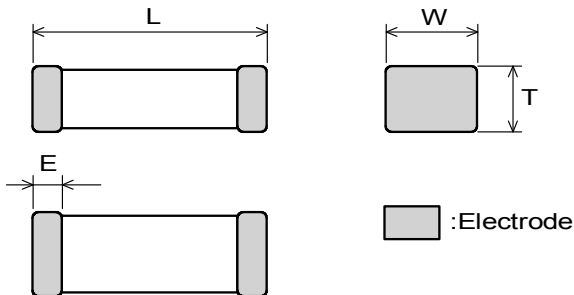

■ Equivalent Circuit



(Resistance element becomes dominant at high frequencies.)

■ Unit Mass (Typical value)

- 0.010g
- 0.014g (for 21BD222SZ1□/21BD272SZ1□)

L	W	T	E
2.0±0.2	1.25±0.2	0.85±0.2	0.5±0.2
		for 21BD222SZ1□ 21BD272SZ1□ 1.25±0.2	

(in mm)

5. Marking

No marking.

6. Specifications

6-1. Electrical Performance

No.	Item	Specification	Test Method
6-1-1	Impedance	Meet item 3.	Measuring Frequency : 100MHz±1MHz Measuring Equipment : KEYSIGHT4291A or the equivalent Test Fixture : KEYSIGHT16192A or the equivalent
6-1-2	DC Resistance	Meet item 3.	Measuring Equipment : Digital multi meter *Except resistance of the Substrate and Wire

6-2. Mechanical Performance (based on Table 13 for FILTER EMI SUPPRESSORS/FILTERS)

AEC-Q200 Rev.D issued June. 1 2010

AEC-Q200			Murata Specification / Deviation								
No.	Stress	Test Method									
3	High Temperature Exposure	1000hours at 125 deg C Set for 24hours at room temperature, then measured.	Meet Table A after testing. <table border="1"> <thead> <tr> <th colspan="2">Table A</th> </tr> </thead> <tbody> <tr> <td>Appearance</td> <td>No damage</td> </tr> <tr> <td>Impedance Change (at 100MHz)</td> <td>Within ±30% (for BLM21SN within ±50%)</td> </tr> <tr> <td>DC Resistance</td> <td>Meet item 3.</td> </tr> </tbody> </table>	Table A		Appearance	No damage	Impedance Change (at 100MHz)	Within ±30% (for BLM21SN within ±50%)	DC Resistance	Meet item 3.
Table A											
Appearance	No damage										
Impedance Change (at 100MHz)	Within ±30% (for BLM21SN within ±50%)										
DC Resistance	Meet item 3.										
4	Temperature Cycling	1000cycles -55 deg C to +125 deg C Set for 24hours at room temperature, then measured.	Meet Table A after testing.								
5	Destructive Physical Analysis	Per EIA469 No electrical tests	No defects								
7	Biased Humidity	1000hours at 85 deg C, 85%RH Apply max rated current.	Meet Table A after testing.								

AEC-Q200			Murata Specification / Deviation						
No.	Stress	Test Method							
8	Operational Life	Apply 125 deg C 1000hours Set for 24hours at room temperature, then measured	Meet Table A after testing. If the rated current of parts exceed 1A, the operating temperature should be 85 deg C.						
9	External Visual	Visual inspection	No abnormalities						
10	Physical Dimension	Meet ITEM 4 (Style and Dimensions)	No defects						
12	Resistance to Solvents	Per MIL-STD-202 Method 215	Not Applicable						
13	Mechanical Shock	Per MIL-STD-202 Method 213 Condition F: 1500g's(14.7N)/0.5ms/ Half sine	Meet Table B after testing. Table B <table border="1" data-bbox="943 656 1455 853"> <tr> <td>Appearance</td> <td>No damage</td> </tr> <tr> <td>Impedance Change (at 100MHz)</td> <td>Within ±30%</td> </tr> <tr> <td>DC Resistance</td> <td>Meet item 3.</td> </tr> </table>	Appearance	No damage	Impedance Change (at 100MHz)	Within ±30%	DC Resistance	Meet item 3.
Appearance	No damage								
Impedance Change (at 100MHz)	Within ±30%								
DC Resistance	Meet item 3.								
14	Vibration	5g's(0.049N) for 20 minutes, 12cycles each of 3 orientations Test from 10-2000Hz.	Meet Table B after testing.						
15	Resistance to Soldering Heat	Solder temperature 260C+/-5 deg C Immersion time 10s	Pre-heating:150C +/-10 deg,60s to 90s Meet Table A after testing.						
17	ESD	Per AEC-Q200-002	Meet Table A after testing. ESD Rank: Refer to Item 3. Rating						
18	Solderability	Per J-STD-002	Method b : Not Applicable 95% of the terminations is to be soldered.						
19	Electrical Characterization	Measured : Impedance	No defects						
20	Flammability	Per UL-94	Not Applicable						
21	Board Flex	Epoxy-PCB(1.6mm) Deflection 2mm(min) 60s minimum holding time	Meet Table B after testing.						
22	Terminal Strength	Per AEC-Q200-006	No defects						
30	Electrical Transient Conduction	Per ISO-7637-2	Not Applicable						

7. Specification of Packaging

7-1. Appearance and Dimensions

Part Number	Type	Appearance and Dimensions	
		a	
BLM21 (except 21BD222SZ1L 21BD272SZ1L)	8mm-wide Paper tape	1.1 max.	
BLM21BD222SZ1L BLM21BD272SZ1L	8mm-wide Plastic tape	1.3 ±0.1	<p>There are holes in the cavity of the Plastic tape $\phi 1.0^{+0.3}_0$</p>

*Dimension of the Cavity is measured at the bottom side.

(in mm)

	Paper tape	Plastic tape
Taping	Products shall be packaged in the cavity of the base tape of 8mm-wide, 4mm-pitch continuously and sealed by top tape and bottom tape.	Products shall be packaged in the each embossed cavity of 8mm-wide, 4mm-pitch plastic tape continuously and sealed by cover tape.
Sprocket hole	Sprocket hole shall be located on the left hand side toward the direction of feed.	
Spliced point	The base tape and top tape have no spliced point.	The cover tape has no spliced point.
Cavity	There shall not be burr in the cavity.	—
Missing components number	Missing components number within 0.1% of the number per reel or 1 pc., whichever is greater, and are not continuous. The specified quantity per reel is kept.	

7-2. Tape Strength

(1) Pull Strength

Paper tape	Top tape	5N min.
	Bottom tape	
Plastic tape	Plastic tape	5N min.
	Cover tape	10N min.

(2) Peeling off force of Top tape·Cover tape

Speed of Peeling off	300mm/min	
Peeling off force *	Paper tape	0.1N to 0.6N
	Plastic tape	0.2N to 0.7N

* Minimum value is typical.

• Case of Paper tape

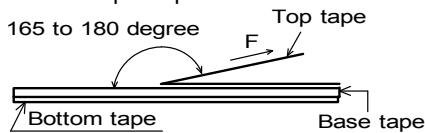

• Case of Plastic tape

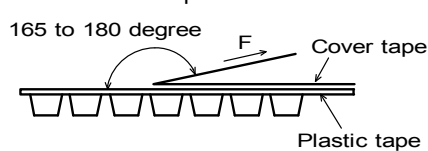

8. ⚠ Caution

8-1. Rating

Do not use products beyond the Operating Temperature Range and Rated Current.

8-2. Surge current

Excessive surge current (pulse current or rush current) than specified rated current applied to the product may cause a critical failure, such as an open circuit, burnout caused by excessive temperature rise.

Please contact us in advance in case of applying the surge current.

8-3. Fail Safe

Be sure to provide an appropriate fail-safe function on your product to prevent from a second damage that may be caused by the abnormal function or the failure of our products.

8-4. Limitation of Applications

Please contact us before using our products for the applications listed below which require especially high reliability for the prevention of defects which might directly cause damage to the third party's life, body or property.

- | | |
|-----------------------------------|--|
| (1) Aircraft equipment | (6) Disaster prevention / crime prevention equipment |
| (2) Aerospace equipment | (7) Traffic signal equipment |
| (3) Undersea equipment | (8) Transportation equipment (trains,ships,etc.) |
| (4) Power plant control equipment | (9) Data-processing equipment |
| (5) Medical equipment | (10) Applications of similar complexity and /or reliability requirements to the applications listed in the above |

9. Notice

This product is designed for solder mounting.

Please consult us in advance for applying other mounting method such as conductive adhesive.

9-1. Land pattern designing

- Standard land dimensions

< BLM21 series(except BLM21PG/BLM21S type) >

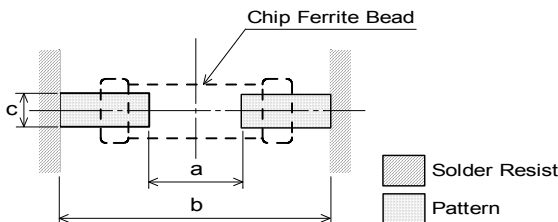

Soldering	a	b	c
Flow	1.1	3.5	0.95
Reflow	1.2	2.4	1.25

(in mm)

< For BLM21PG/S type >

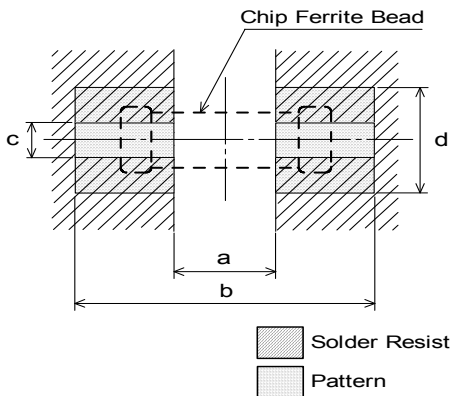

Type	Rated Current (A)	Land pad thickness and dimension d		
		18μm	35μm	70μm
BLM21PG	1.5	1.25	1.25	1.25
	2	1.25	1.25	1.25
	3~4	2.4	1.25	1.25
	6	6.4	3.3	1.65
BLM21S	1~8.5	-	6.8	3.4

(in mm)

Soldering	a	b	c
Flow	1.1	3.5	0.95
Reflow	1.2	2.4	1.25

(in mm)

*The excessive heat by land pads may cause deterioration at joint of products with substrate.

9-2. Soldering Conditions

Products can be applied to reflow and flow soldering.

(1) Flux, Solder

Flux	Use rosin-based flux, but not highly acidic flux (with chlorine content exceeding 0.2(wt)%.) Do not use water-soluble flux.
Solder	Use Sn-3.0Ag-0.5Cu solder Standard thickness of solder paste : 100 μm to 200 μm

(2) Soldering conditions

- Pre-heating should be in such a way that the temperature difference between solder and ferrite surface is limited to 150°C max. Also cooling into solvent after soldering should be in such a way that the temperature difference is limited to 100°C max.

Insufficient pre-heating may cause cracks on the ferrite, resulting in the deterioration of product quality.

- Standard soldering profile and the limit soldering profile is as follows.

The excessive limit soldering conditions may cause leaching of the electrode and / or resulting in the deterioration of product quality.

(3) soldering profile

□Flow



	Standard Profile	Limit Profile
Pre-heating	150°C、60s min.	
Heating	250°C、4~6s	265°C ± 3°C、5s max.
Cycle of flow	2 times	2 times

□Reflow soldering profile

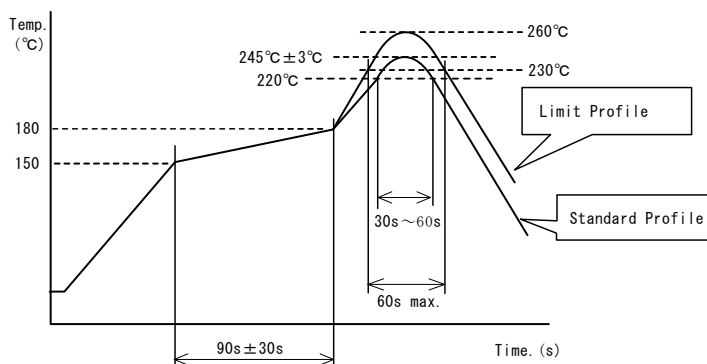

	Standard Profile	Limit Profile
Pre-heating	150~180°C、90s ± 30s	
Heating	above 220°C、30s~60s	above 230°C、60s max.
Peak temperature	245 ± 3°C	260°C, 10s
Cycle of reflow	2 times	2 times

9-3. Reworking with soldering iron

- Pre-heating: 150°C, 1 min
- Tip temperature: 350°C max.
- Soldering time : 3(+1,-0) seconds.
- Soldering iron output: 80W max.
- Tip diameter: φ 3mm max.
- Times : 2times max.

Note :Do not directly touch the products with the tip of the soldering iron in order to prevent the crack on the ferrite material due to the thermal shock.

9-4. Solder Volume

Solder shall be used not to be exceed as shown below.

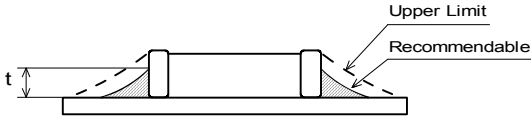

$$1/3T \leq t \leq T$$

(T:Chip thickness)

Accordingly increasing the solder volume, the mechanical stress to product is also increased. Exceeding solder volume may cause the failure of mechanical or electrical performance.

9-5. Attention regarding P.C.B. bending

The following shall be considered when designing and laying out P.C.B.'s.

- (1) P.C.B. shall be designed so that products are not subject to the mechanical stress for board warpage.
<Products direction>

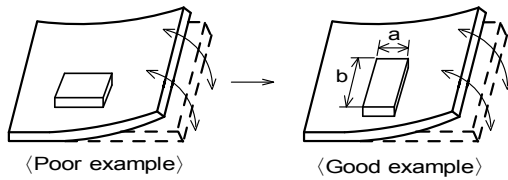

Products shall be located in the sideways direction (Length:a<b) to the mechanical stress.

- (2) Components location on P.C.B. separation.

It is effective to implement the following measures, to reduce stress in separating the board. It is best to implement all of the following three measures; however, implement as many measures as possible to reduce stress.

Contents of Measures	Stress Level
(1) Turn the mounting direction of the component parallel to the board separation surface.	A > D *1
(2) Add slits in the board separation part.	A > B
(3) Keep the mounting position of the component away from the board separation surface.	A > C

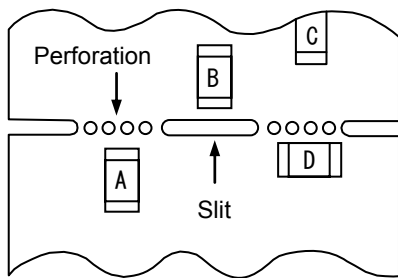

*1 A > D is valid when stress is added vertically to the perforation as with Hand Separation. If a Cutting Disc is used, stress will be diagonal to the PCB, therefore A > D is invalid.

(3) Mounting Components Near Screw Holes

When a component is mounted near a screw hole, it may be affected by the board deflection that occurs during the tightening of the screw. Mount the component in a position as far away from the screw holes as possible.

**9-6. Mounting density**

Add special attention to radiating heat of products when mounting the inductor near the products with heating. The excessive heat by other products may cause deterioration at joint of this product with substrate.

9-7. Operating Environment

Do not use this product under the following environmental conditions, on deterioration of the Insulation Resistance of the Ferrite material and/or corrosion of Inner Electrode may result from the use.

- (1) in the corrodible atmosphere such as acidic gases, alkaline gases, chlorine, sulfur gases, organic gases and etc. (the sea breeze, Cl₂, H₂S, NH₃, SO₂, NO₂, etc)
- (2) in the atmosphere where liquid such as organic solvent, may splash on the products.
- (3) in the atmosphere where the temperature / humidity changes rapidly and it is easy to dew.

9-8. Resin coating

The impedance value may change and/or it may affect on the product's performance due to high cure-stress of resin to be used for coating / molding products. So please pay your careful attention when you select resin. In prior to use, please make the reliability evaluation with the product mounted in your application set.

9-9. Cleaning Conditions

Products shall be cleaned on the following conditions.

- (1) Cleaning temperature shall be limited to 60°C max. (40°C max. for IPA.)
- (2) Ultrasonic cleaning shall comply with the following conditions, avoiding the resonance phenomenon at the mounted products and P.C.B.
Power:20W/ℓ max. Frequency:28kHz to 40kHz Time:5 min max.
- (3) Cleaner
 1. Alternative cleaner
 - Isopropyl alcohol (IPA)
 2. Aqueous agent
 - PINE ALPHA ST-100S
- (4) There shall be no residual flux and residual cleaner after cleaning.
In the case of using aqueous agent, products shall be dried completely after rinse with de-ionized water in order to remove the cleaner.
- (5) Other cleaning
Please contact us.

9-10. Handling of a substrate

After mounting products on a substrate, do not apply any stress to the product caused by bending or twisting to the substrate when cropping the substrate, inserting and removing a connector from the substrate or tightening screw to the substrate.

Excessive mechanical stress may cause cracking in the product.



9-11.Storage Conditions

(1) Storage period

Use the products within 6 months after delivered.

Solderability should be checked if this period is exceeded.

(2) Storage conditions

- Products should be stored in the warehouse on the following conditions.

Temperature : -10°C to 40°C

Humidity : 15% to 85% relative humidity

No rapid change on temperature and humidity

- Don't keep products in corrosive gases such as sulfur, chlorine gas or acid, or it may cause oxidization of electrode, resulting in poor solderability.
- Products should be stored on the palette for the prevention of the influence from humidity, dust and so on.
- Products should be stored in the warehouse without heat shock, vibration, direct sunlight and so on.
- Products should be stored under the airtight packaged condition.

(3) Delivery

Care should be taken when transporting or handling product to avoid excessive vibration or mechanical shock.

10.  Note

- (1) Please make sure that your product has been evaluated in view of your specifications with our product being mounted to your product.
- (2) You are requested not to use our product deviating from the agreed specifications.
- (3) The contents of this reference specification are subject to change without advance notice. Please approve our product specifications or transact the approval sheet for product specifications before ordering.